



PRODUCTS SOLUTIONS

2019



Continuously shaping the future together

Also in the year 2019 we only have one goal: to continue working successfully with you with high-quality products and innovative solutions but also with new components that have been added to our portfolio.

The latest edition of the "Products and Solutions" catalog offers you a comprehensive overview of proven series products, such as the gearmotors with AC motors of the DRN.. series – with energy efficiency class IE3 as standard. But the catalog also contains new and innovative products that have been added to the portfolio in the last years, such as the modular MOVI-C® automation system.

New products for 2019, such as the new synchronous servomotors of the CM3C.. series, planetary precision servo gear units of the PxG series, or the premium gear unit oil "SEW GearOil", are provided in a special supplement. As always, this edition also covers our comprehensive range of services.

We offer services designed for the entire life cycle of your system so that you can maximize reliability and benefit from the expertise of a skilled partner.

No matter what your line of business may be, our portfolio is tailored to your specific needs and applications.

Take your time to go through the new edition of "Products and Solutions" and do not hesitate to contact our experts for tackling your next challenge.

Good luck with your future ventures!

Yours,



Jürgen Blickle
Managing Partner





DRIVING THE WORLD

YOUR PARTNER	12
--------------	----

SERVICES

OUR LIFE CYCLE SERVICES	16
OUR SERVICES AND TOOLS	32
EASY SUPPLIER INTEGRATION SERVICES	33
PROCUREMENT	36

AUTOMATION

OUR OFFERS	38
THE REAL 4.0	42
APPLICATION EXAMPLES	48
SYSTEM SOLUTIONS	50
MACHINE AUTOMATION	60
INDUSTRIAL GEAR UNIT SOLUTIONS	64

PRODUCTS

MOVI-C® MODULAR AUTOMATION SYSTEM	76
01 GEARMOTORS	94
02 GEAR UNITS	118
03 MOTORS	146
04 INDUSTRIAL GEAR UNITS	196
05 DECENTRALIZED DRIVES / MECHATRONICS	214
06 INVERTER TECHNOLOGY	242
07 SERVO DRIVE TECHNOLOGY	280
08 INDUSTRIAL COMMUNICATION	282
09 CONTROL TECHNOLOGY	294
10 SOFTWARE	308
11 SAFETY TECHNOLOGY	320
12 CONTACTLESS ENERGY TRANSFER SYSTEM	340
13 DIDACTICS MODULES	350

DRIVING THE WORLD



YOUR PARTNER

OUR DRIVE IS WHAT KEEPS YOUR BUSINESS MOVING.
WE ARE YOUR PARTNER – WE ARE ON YOUR LEVEL
WORLDWIDE WHEREVER YOU NEED US.





- Argentina
- Australia
- Austria
- Belarus
- Belgium
- Brazil
- Cameroon
- Canada
- Chile
- China
- Colombia
- Czech Republic
- Denmark
- Finland
- France
- Germany
- Ghana
- Hungary
- India
- Italy
- Ivory Coast
- Japan
- Kazakhstan
- Malaysia
- Mexico
- Morocco
- Netherlands
- New Zealand
- Norway
- Paraguay
- Peru
- Poland
- Portugal
- Russia
- Singapore
- Slovakia
- Spain
- South Africa
- South Korea
- Sweden
- Switzerland
- Tanzania
- Thailand
- Turkey
- Ukraine
- United Kingdom
- United Arab Emirates
- United States of America
- Uruguay
- Venezuela
- Vietnam



51 countries



16 production plants



More than 17 000 employees



79 Drive Technology Centers



Global service



At home in numerous
industries

OUR LIFE CYCLE SERVICES

GOOD PARTNERS ARE THERE FOR YOU,
EVEN WHEN EVERYTHING IS RUNNING SMOOTHLY.
NO MATTER WHEN, NO MATTER WHERE.





Tailored to your requirements: Services along the system's entire life cycle

In today's world, production processes are becoming increasingly complex. This has a knock-on effect on services, which have to adapt and grow at the same pace.

Customized offers are what is required – throughout the system's entire life cycle. This begins in the orientation phase and continues all the way through to the operation and modernization of your machinery and systems.

We would like to support you in this by providing you with the service you need right now and giving you the best possible assistance. This might involve personal support with project planning and design during your planning and engineering phase, or it could be a comprehensive range of repair services, including picking up the components, during the operation phase, if things are urgent.

Our scalable services enable us to offer tailor-made solutions from a single source and thus meet your specific requirements throughout the system's life cycle.





- **Everything from a single source**

You receive services, tools and resources that are closely linked to our product portfolio – and all from a single source.

- **One contact person**

We are there for you, and show personal commitment. Worldwide.

- **Reliability**

You receive reliable, rapid assistance that ensures the reliability of your production processes.

- **Expertise and advice**

You can build on expertise in drive and automation technology going back more than 87 years coupled with customized advice.



Orientation

To ensure we embark on the correct path together.

Before you invest in new systems, components and services you need an overview that is as comprehensive and specific to your situation as possible: What rules and regulations have to be adhered to? Are there any trends and innovations that have to be taken into account? Which solution is best suited to my needs? We aim to provide you with helpful information that will make the orientation and decision-making process easier for you.

Our wide-ranging sales and service network means we are always nearby and can support you with customized, personal consulting during this vital phase.

Our website, newsletter and specialist articles may also be able to provide you with the information you're looking for.

The following services are available to you:

Personal consulting:

- **Current and future trends**

We have our eyes and ears on the pulse. We would be happy to examine current and future trends with you, particularly in the field of drive and automation technology.

- **Rules and regulations**

We will be happy to advise you on complying with current standards and legal requirements in terms of energy efficiency, explosion protection and safety technology, for example.

- **Application and industry expertise**

Benefit from our extensive experience in a range of industry sectors and applications around the world.

- **Knowledge transfer**

We will provide current information and trends from a number of associations, including the German Engineering Federation (VDMA) and the German Electrical and Electronic Manufacturers' Association (Zentralverband Elektrotechnik- und Elektronikindustrie, ZVEI).

- **Information sharing at innovation level**

Our sales and product engineers are available to discuss your requirements. If necessary, we can also involve our researchers from the development departments.



Support tools & resources
that are available to you:

- Website
- Information brochures
- Specialist articles and newsletters
- Social media channels
- Trade fairs and customer events



Planning & Engineering

To enable you to turn your ideas, requirements and concepts into tailor-made drive and automation solutions.

Optimized planning – before you even place your order – is our top priority, with everything monitored by our technical experts who have detailed knowledge of your sector and applications. We are there for you in person, with 41 sales and service sites in Germany alone, to provide direct advice in project planning and engineering issues and answers to how you can effectively cut the maintenance costs for your systems during the operation phase. If you wish, you can simply use our helpful "Planning and Engineering Tools" from the comfort of your own workplace.



The following services are available to you:

● **Concept development**

We work with you to determine your drive and automation technology needs and develop tailored concepts for your drive, automation and safety technology. This includes, for example, jointly developing performance specifications for applications programming or defining customized installation and drive safety concepts.

● **Project planning and design**

In the planning phase, we help you select and configure your drive components. In addition, we conduct project planning for your complex drive systems, taking into account safety and energy requirements. You can find all the technical information and CAD data for the selected products at the push of a button. The final plausibility check, preliminary startup and system simulations in this error-free project planning stage save you time and money.

● **Engineering**

Whether it be modernization measures, the planning of new systems or implementing MAXOLUTION® system solutions, we always support you with the engineering services you need. From control cabinet planning, creating wiring diagrams and mechanical modifications during modernization measures all the way to project-specific software adjustments, system simulations and complete project management, we work closely as your partner through every stage.

● **Operation and maintenance concepts**

We help you in the planning and engineering phase to develop customer-specific operation and maintenance concepts for the operation phase, and thus lay the foundations for reduced operating and maintenance costs, maximum system availability and even optimized storage costs.

● **Training**

Stay at the top of your sector in terms of drive expertise. Our wide-ranging training portfolio ensures you make practical progress. See for yourself what SEW-EURODRIVE's DriveAcademy® has to offer in the way of training.

● **Variant management**

We support you in the planning phase to standardize and minimize product variants and simplify your master data management. Comprehensive advice about technical details and filter opportunities in our central database help you to select the suitable product.

Support tools & resources that are available to you:

● **NEW: Drive selection**

● **Product configurator**

● **Energy efficiency tools**

● **Variant management**

● **Safety technology selection aid**

● **Planning and configuration tool (Workbench)**

● **CDM® database**

● **SISTEMA software utility**



Procurement & Delivery

To ensure your procurement processes run smoothly and your logistics outlay is reduced.

We offer extra process efficiency and consulting in the procurement process. You can benefit from our expertise during the “Procurement & Delivery” phase and the advantages this provides, such as increased speed and quality in dealing with your inquiries and orders, and ensuring smooth logistical processes. We are happy to support you in person with tailored solutions. Decide which services are right for you!

The following services are available to you:

- **Delivery service**

With our delivery service, we meet your specific wishes, be it our standard or express shipping or even delivery directly to your construction site by courier. We are happy to accommodate specific packaging requests.

- **Barcode labels (DriveTag)**

DriveTags are functional barcode labels that are attached to products or packages. They contain data defined by you (e.g. the SEW serial number, your material number or your project number), and ensure simple identification and efficient assignment of products at every process step – from receipt of goods, through storage and on to the downstream stages.

- **Electronic data interchange (EDI)**

We help you manage your entire order management electronically with us – From ordering, order confirmation and notification of dispatch all

the way to billing. We advise you on what the best option would be, either using platforms such as MyOpenFactory, Basware, Seeburger AG or via direct link to standard formats such as EDIFACT or XML.

- **Electronic billing**

This service ensures quick availability of your invoices, saves time and helps the environment. Optimize your processing of incoming invoices and your administrative processes – regardless of whether invoices are sent by e-mail, with an additional invoice file in ZUGFeRD format (“Comfort” data profile) or by EDI.

- **Electronic notification of dispatch**

Electronic notification of dispatch is a goods notification service. We let you know as soon as your delivery leaves our premises. This keeps you in the picture and enables you to take the necessary steps. As a result, you benefit from optimized resource planning, precise control of production planning and speedy goods receipt processes.



Support tools & resources
that are available to you:

- **Transaction overview**
- **Create a shopping cart/inquiry or order**



Installation & Startup

To ensure your drives and systems are up and running quickly, cost-effectively and successfully.

Do you want to do everything right even in the installation and startup phase?

Do you want to ensure your system is operating correctly by having the installed drive technology inspected? Do you want to optimize your machinery and system processes using tailor-made, application-specific programming? Or do you want to cut costs and prevent consequential damage with professional support during startup?

The following services are available to you:

- **Installation consulting**

We help you properly install your drive technology. You can benefit from our project experience to shorten your installation time and safeguard your system functionality. We are happy to provide support at every step, from inspecting the mechanical and electrical installation to complete project planning in relation to the drive technology.

- **Application programming**

In many cases, the drive components achieve their full functionality only with the right software solution. Let our experts help you optimize the benefits and functions of your drive technology. We will happily create tailored drive component software for your applications.

- **Startup**

We start up all your drive technology, taking account of current safety regulations and set all parameters to optimize reliability and efficiency. This applies to both new and modernized systems. We are happy to discuss the optimum operation of your drives and systems while you are watching us at work.

Support tools & resources
that are available to you:

- **MOVITOOLS® MotionStudio**

- **MOVISAFE®**

- **MOVIVISION®**

- **Software LT Shell**

- **MOVISUITE®**

- **Libraries and application modules**

We provide professional support all the way from installation consulting and application programming to startup – either in person through experienced service experts or through user-friendly tools. This saves time, money and nerves.





Operation

To ensure your system operates reliably and efficiently – long term.

The operation phase tends to be the phase within the life cycle of your system that has the greatest impact on the life cycle costs of your machinery and system. We aim to help you keep these costs to a minimum and thus continuously improve the availability and productivity of your system. Prepare to be impressed by our tailored services such as our remote service, our comprehensive range of repair services, including Pick-Up and Delivery Service, and our energy consulting as a support service for your energy management system.



The following services are available to you:

● Production support

Our experts will be pleased to provide you with support during your production startup. This makes it possible to identify problems as soon as they arise and intervene early to remedy them. We will supervise the drive technology during the startup phase, train your staff if necessary, and help you optimize your process sequences.

● Remote service

We will use remote access to support you in diagnosing the current status of your drive technology and in appropriate fault evaluation. These and many more services are available to you at any time and worldwide. All you need is an on-site computer with an Internet connection. You do not need to install any additional software. This boosts productivity and minimizes your downtimes.

● Repairs

Should repairs be required, we can help. Even for products from other manufacturers. Our repair services are tailored to your needs and range from simple emergency repairs and functional repairs all the way to as-new repair work with a 24-month liability for defects on the complete drive. And if things have to be done in a hurry, ask about our rush order repairs and our on-site service.

● Inspection & Maintenance

We can raise your operational safety and system availability with our comprehensive range of inspection and maintenance services, including endoscopy for the fast diagnosis of your gear unit or the comprehensive analysis of your gearmotor oil as part of the oil check. We will happily check your entire drive technology in an existing system and give you a 12-month performance guarantee on all drive components we have checked and found to be in working order. Simply ask about the SEW Quick check.

● Spare parts service

Even if you carry out the repairs yourself, in 95% of cases we will dispatch the spare parts required on the same day. No matter whether you contact us personally or use our Online Support to place the order. We guarantee immediate availability and provision of original SEW-EURODRIVE replacement parts.

● Pick-Up and Delivery-Service

Our Pick-Up and Delivery Service ensures fast pick-up and delivery of your drive technology coupled with support from our service experts to help you disassemble and reassemble the drive components. Thanks to our wide-ranging network of service sites, we are always nearby, and can ensure quick response times. We will be happy to also take over all the transport logistics. Simply ask about the Pick-Up Box.

● Express assembly

In urgent cases involving replacement or new gearmotors or electronic products, our highly skilled service staff will provide expert assistance. With 41 service sites in Germany alone, our wide-ranging customer support and service network generally enables us to assemble and deliver the drive components on the same day they are ordered. For you, this means greater process reliability and shorter cost-intensive downtimes.

● Condition monitoring

Our condition monitoring is based on systematically determining the condition of all drive technology and drive automation. You receive entire concepts, from initial consulting and designing of the optimal analysis method all the way through to installation and diagnostics. Minimize your production downtimes and utilize our brakes diagnosis or SmartCheck vibration sensor, for example.

● 24h Service Hotline

Trained technicians and engineers are available for you round the clock – whether to provide technical information or to arrange rush orders for repairs, express assemblies and replacement part dispatch.

● Energy management

Our energy experts will help you optimize the energy efficiency of your machinery and systems and decide on the best way to use energy-optimized drive systems. This will enable you to boost the energy-efficiency of your system and reduce your energy costs, and you will also receive an energy report from us to prove the success for your energy management system.

Support tools & resources that are available to you:

● Energy efficiency tools

● Variant management

● Troubleshooting

● Replacement parts or replacement product selection

● Scope diagnostic function

● CDM® database



Modernization

To ensure you are using state-of-the-art technology and achieve the best possible productivity, process reliability and performance.

As the service life of a machine or system increases, changes occur in both the framework conditions such as legal and standards requirements and the requirements relating to productivity, system availability, performance and parts availability.

Sooner or later, you will face a decision about whether it is time to consider modernizing a system – or even just parts of it. This can bring with it great economic advantages.

We know that system modernization is an extremely challenging engineering and service undertaking, and we are keen to work closely with you to make it a success.

The following services are available to you:

- **Retrofit**

We update your system with state-of-the-art technology. You boost your productivity and energy efficiency, reduce your maintenance costs by using service-friendly products and receive long-term parts availability. Thanks to our retrofit service, you receive everything from a single source – personal consulting and engineering, cutting-edge drive technology, programming and visualization, and of course complete installation and startup.

Support tools & resources are available to you throughout the entire system life cycle.



Tools & Resources – all in one place in Online Support

Alongside personal advice at every stage of the system life cycle, you can also benefit from our tools and resources. We have brought together the ones that are available online in our Online Support. You can use Online Support, for example, to select products and spare parts and directly request or order them, to download documents or CAD data, to check processes, etc.

Welcome to the Online Support!

Processes

- Engineering & selection**
 - > Drive Selection
 - > Product configurator
 - > Variant management
 - > Select replacement product
 - > Energy efficiency tools
 - > Selection guide for functional safety
- Inquiry & order**
 - > Create inquiry or order
 - > Transaction overview
 - > Templates
 - > Quotations
 - > Orders
 - > Service transactions
- Delivery & material flow**
 - > Order status
 - > Request dispatch notification
- Startup & maintenance**
 - > Select spare part
 - > Request Pick-Up and Delivery Service
 - > Troubleshooting
 - > CUMD database
 - > Return process
 - > Check & activate software licenses

Data & documents

- > CAD data
- > Documentation
- > Product data
- > Software

Individual settings

- > Forgot password?
- > Registration
- > Login
- > Workbench registration

Related links

- > Brief instructions for Online Support
- > Mobile applications
- > Newsletter
- > Project rooms

Online Support hotline

Do you need help with Online Support?

+49 7261 75-3232
online.support@sew-eurodrive.de

Do you need help with a product?

0800 7394357

The structure is based on the stages of the life cycle and ensures straightforward, direct access to the functions relevant to you.

Many of the functions available can be accessed without a login. You can also register and gain access to more functions. Registered users can change the settings in their own personal area.

Data & documents is a simple and fast way to find information on our products: CAD data, product data, software and technical documentation.

NEW Drive selection: A new online tool for quickly finding and calculating the perfect gearmotor for your application.

Many possibilities, one access point:
 Discover our Online Support.
www.sew-eurodrive.de/en/online_support



ESIS® – Easy Supplier Integration Services

Seamless online order processing and access to information

ESIS® (Easy Supplier Integration Services) is used to link your IT system to our Online Support functions at no cost. The automated data transfer of ESIS® Comfort cuts out time spent on e-mail and fax orders and complicated transfer of data. You can easily retrieve product documentation and much more information from your system using ESIS® Information links. This not only saves you valuable time but also eliminates potential sources of error thanks to automatic data transfer.

All benefits at a glance:

- **Cross-supplier link scheme**
Standardized links connect your system with the supplier system
- **Easy integration into your own systems**
Direct access to information such as product data and prices, CAD models, order and delivery status
- **No more manual data entry**
High process reliability and time savings due to automatic transfer of quotation and order data

Cross-supplier cooperation

ESIS® is an initiative launched by leading automation technology suppliers Festo, SICK and SEW-EURODRIVE. We work together to simplify your e-business and eliminate sources of error. What's more, the network is continuing to grow: HERMA, Harting and other partners are already getting involved. Automate your processes with ESIS® interfaces!

An initiative of:



www.sew-eurodrive.de/en/esis

NEW: Drive selection

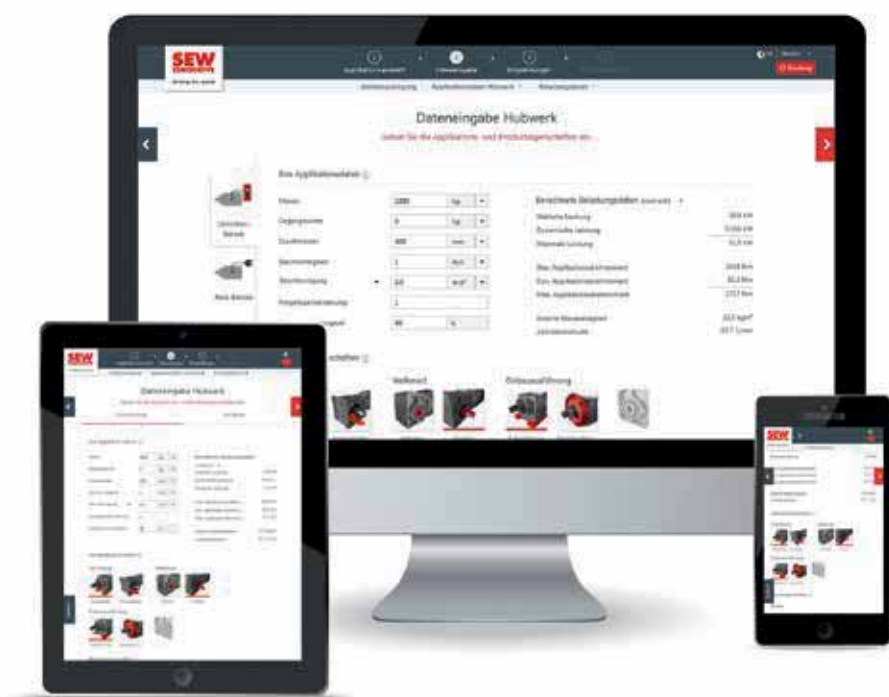

You are familiar with your application and we know the matching drive technology – all you have to do is to enter a few data and the new "Drive Selection" online tool will find and select the gearmotor matching your application.

In step 1, you select an application, in step 2, you enter all the associated application data. Pressing a button then already provides a first recommendation on what the drive could look like. The tool also provides comparisons with several gearmotors that would also match.

All this works without a user login or registration. It is only when you send us a query about the drive or want to order it that we need your data.

Drive selection made easy –
give it a try now.



Mobile applications

On the road and need access to technical data and documentation? Or are you trying to identify faults in SEW-EURODRIVE drive components on site in your system?

Our apps make it easy.



SEW Product ID plus



SEW Diagnostics



Fast access on the move – see for yourself and find out about our cell phone apps here.

Procurement at SEW-EURODRIVE

Procurement 360° – reflects the philosophy of the integrated approach that guides our procurement department's decisions and successful international operations. A forward-thinking procurement system has to be fully networked. This is why, in addition to working closely with areas such as development, production, quality management and logistics, we also link in global procurement operations from SEW-EURODRIVE. As well as collaborating closely within the company, we also place great value on communicating regularly with our suppliers, understanding our customers' requirements, and cooperating with industry associations and high-profile universities.

Procurement 360°
See the big picture



Overview of our networked system

Sourcing

- A worldwide standard – Selecting suppliers on the basis of criteria agreed across SEW-EURODRIVE keeps our standards of quality high.
- Global sourcing market transparency – We identify opportunities and risks in good time and act in close cooperation with our decentralized procurement organizations.

Supplier management

- Integrated approach – The SEW-EURODRIVE Supplier Management Toolbox is used worldwide. From selecting suppliers right through to evaluation and supplier development.
- Shoulder to shoulder – Experts from our procurement, development, quality and logistics departments make decisions together through Supplier Steering Committees.

Quality management

- Vigilance and preparation – Feasibility studies before series production, rapid intervention and direct communication with suppliers all help to keep processes smooth.
- Multi-stage escalation management – Action is planned and follow-up implemented in coordination with those responsible within the supply chain.

Risk management

- Prevention – Early identification of supplier-related risks avoids disruption of operations. The entire supplier pool is monitored via the Critical Supplier Watchlist.
- Trend radar – Closely observing sourcing markets, political events and technology trends supports proactive initiatives.

Legal regulations

- Product conformity – We use active, cross-functional moderation processes to ensure that legal requirements are understood and complied with throughout the value chain.
- Sustainability – In addition to economic factors, social, ethical and environmental issues play a key role in our day-to-day decisions and operations.

Process optimization

- Digitalization – We build up highly automated processes with future-focused technology and global networking.
- Coordination across interfaces – We work with both internal and external business partners to harness all available potential.

Organization

- Close to the action – Targeted procurement specialists work on site within production plants and innovation departments.
- Source of value – Enthusiasm for tomorrow's hot topics, ongoing development and active knowledge transfer are what drive us every day.

Reporting

- Visualization – Buyer tools include clear supplier performance overviews, flexible ad-hoc evaluations and independent analyses.
- Facts & expertise – Decision-making is based on valid indicators and supported by interdisciplinary specialist expertise.

An integrated, process-focused approach is central to the way our procurement system works. This depends on cross-section collaboration and forward-looking supplier management.

Any questions?
Contact our procurement department.
procurement360@sew-eurodrive.de



AUTOMATION

THINK BIG TO REAP BIG REWARDS.
OUR SOLUTIONS FOR TOMORROW, AVAILABLE NOW – WORLDWIDE





Solutions from SEW-EURODRIVE

Do you have completely new or very specific challenges for us? No matter what your industry is, we are there for you worldwide and are constantly improving our components, modular concept and solutions.



We at SEW-EURODRIVE create and implement solutions today for the tasks of tomorrow:

- THE REAL 4.0
- Innovative system solutions
- Industry- and application-specific machine automation
- Wide range of robust industrial gear units

This will enable us to meet the challenges that lie ahead and always offer you exactly what you need – today, tomorrow and further into the future.



THE REAL 4.0 = SEW-EURODRIVE

Industry as a whole is on the brink of massive upheaval shaped by ever-increasing networking and the Internet. This development is so major and fundamental that many experts are calling it a fourth industrial revolution, "Industry 4.0." On the following pages, we want to share our vision of the Factory 2020 with you.

The real world and virtual world will merge.

This approach promises to lead to completely new production methods and processes. The new feature of this approach is that, not only do machines and integrated systems communicate with each other, but all systems are intelligently linked through Industry 4.0, allowing them to exchange

information with the products to be manufactured, virtually in real time. Machines will be able to think for themselves and will detect when specific materials need to be replenished. They will then autonomously report this demand to other systems that will automatically trigger order placement.

The principle of increased intelligent networking delivers significant savings in costs, time and efficiency for companies that adopt a consistent approach. It is estimated that savings of approxi-

mately 30 percent compared to conventional production methods can be achieved.

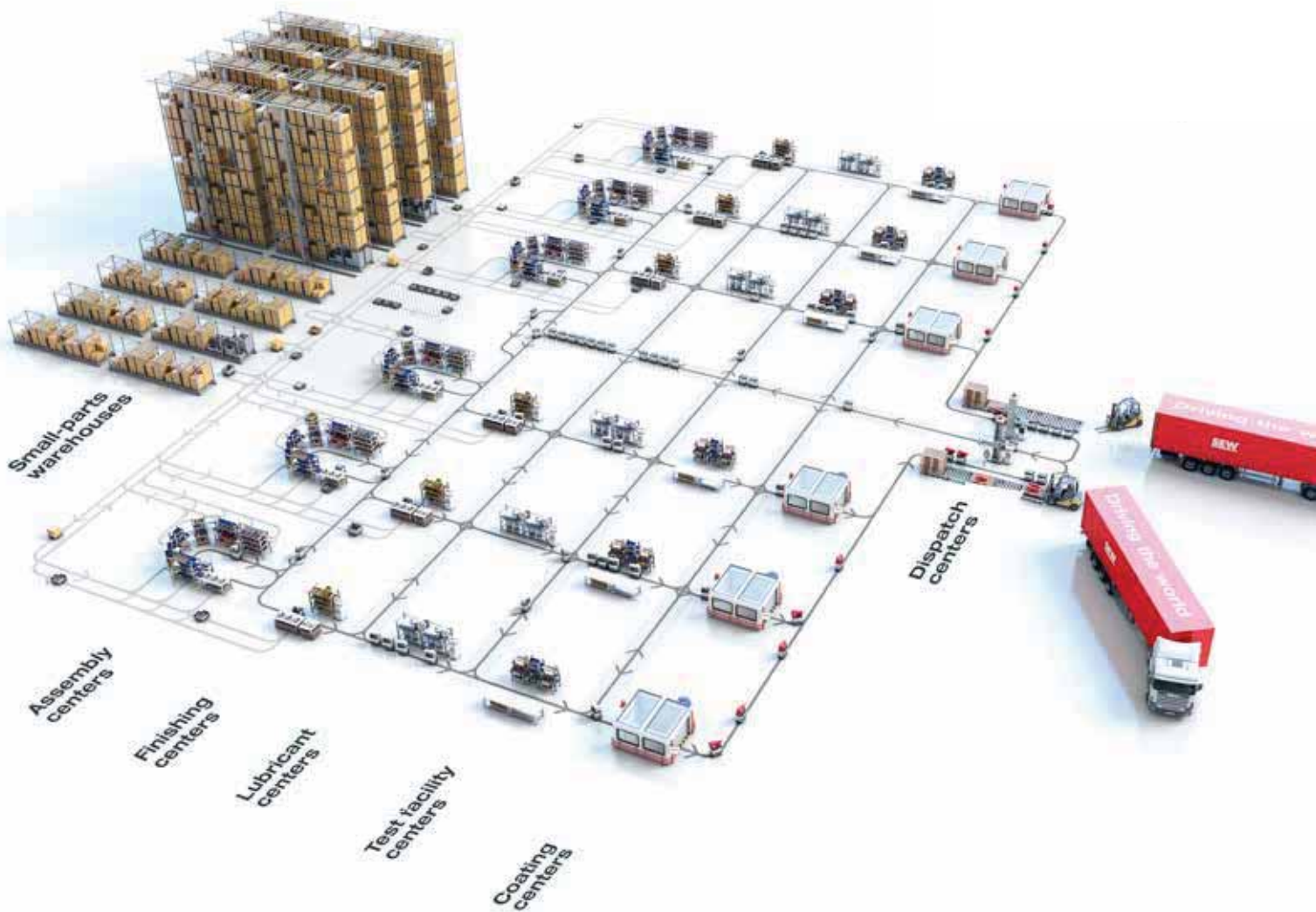

Industry 4.0 – Our version of the Sm@rt Factory 2020:

Realizing perfectly implemented lean principles and technology approaches of Industry 4.0 and thus creating factories based on the successful philosophy "Intelligent interaction of people and technology within the work processes". We create value-based, waste-free, flexible, and motivating work processes and support them by means of integrated intelligent automation solutions across all areas. Currently separated functions such as production, assembly, and logistics will be intelligently linked and thus are combined into one integral system with Industry 4.0.

Increased productivity in plant logistics

The introduction of Integrated Industry will allow us to revolutionize the management of product development and the value creation chain. Rigid production structures in factories will be loosened

and transformed into active, autonomous and self-organizing production units. This requires e.g. mobile assembly and logistics assistants.



Taking into account the 'one piece flow' and 'small factory unit' value creation principles, we are currently conducting a project to modernize and optimize material transport at the company's own production plant in Graben-Neudorf.

We at SEW-EURODRIVE have been working for some time on this new modular technology system that enables intelligent, innovative and cost-optimized application solutions. New technical possibilities in transport logistics even as far as robotic systems have been and will be generated primarily through innovations in the fields of induc-

tive and optical track guidance, contactless energy transfer and energy storage, safety technology, radio and navigation, sensor technology, drive technology and parameterizable control systems.



Efficient processes save time and money

At SEW-EURODRIVE, we use our own solutions in production and logistics – this means a daily test of our products under real-life conditions. This is also why we focus to a great extent on the energy supply of our application solutions.

Back in the 1990s, we developed the technology for the **MOVITRANS® contactless energy transfer system**. Since then, we have been adapting the system to changing market requirements and working on it continuously, particularly with regard to Industry 4.0.



MOVITRANS® is made up of stationary and mobile components for contactless power supply to moving electrical loads. The required energy is transferred via electromagnetic fields (contactless) from a coil or an insulated stationary conductor via an air gap to the mobile consumers (vehicles) either selectively at specific points or along a track. Compared to conventional energy transfer, e.g. using contact lines or charging stations,

the MOVITRANS® system is particularly low wear, making it maintenance-free. With the contactless energy transfer system, there is no longer need for heavy batteries, which has a long-term effect on the design of the mobile assistance system. The line cables on the main tracks supply the vehicles with energy when they cross them. Charging a battery is no longer required. The vehicles can thus be used in 3-shift operation as no

breaks for charging the battery are required. At the same time, fewer mobile assistants are needed compared to a system with battery-supplied vehicles. Resources are used responsibly, especially regarding the inevitable battery exchange for battery-supplied vehicles.

Another example is **our short-term energy storage system** for flexible travel tracks.

To store electric energy, the DC voltage storage unit is expanded with electric capacitors or batteries. This is made possible by energy modules that are made of innovative double layer capacitors. The DC-to-DC converter connected between the grid connection and the energy modules allows in-

dividual control of the stored energy. The storage unit is charged actively and the stored energy can be used by the consumers. Using the short-term energy storage system from SEW-EURODRIVE, application-specific power supply interruptions can be bridged and extremely flexible plant concepts realized. In regard to the digital factory and the importance of swarm technology, this system plays a

central role in creating the future. The reduced installation technology of such systems is particularly useful during power failures or line interruptions.



Find out more information on our Industry 4.0 projects "made by SEW-EURODRIVE".
www.sew-eurodrive.de/en/smart-factory

Possibilities at a glance – sample applications

MAXOLUTION® from SEW-EURODRIVE delivers tailor-made system solutions with a built-in guarantee of success. Our MAXOLUTION® system solutions offer innovative modules for creating customized machinery and systems that perfectly match your requirements.

Innovative, customized MAXOLUTION® system solutions



Cartoning machine with materials handling technology



Automated guided vehicle system (AGV)



Safety electrified monorail system (EMS Safety)

They range from electromechanical drives, controllers, communication, visualization, simulation/emulation and contactless energy transfer systems to the varied service portfolio that provides you with fast and reliable support from experienced professionals. Our system specialists form a core

team that delivers industry-specific expertise and works closely with the sales and service staff you are already familiar with.

Your added value: Everything from a single source. We ensure you receive the best possible advice and support, with fewer interfaces and just one contact for the entire system solution. Fast, straightforward and comprehensive with a constant focus on your needs.



Storage/retrieval system (SRS)



Pallet transfer shuttle

Customized solutions for the automotive industry – innovative and reliable

The MAXOLUTION® system specialists always have their eyes on the big picture – from problem-solving skills to system availability – utilizing their many years of market knowledge and experience. SEW-EURODRIVE is using the MAXOLUTION® system solutions for the automotive industry again this year to prove its innovative credentials. Check it out for yourself!



Electrified monorail system – EMS safety

- Intelligent drive control with MOVIVISION® (see EMS advanced)
- Innovative safety functions:
 - Safe brake system with SBS diagnostics
 - Safe positioning (SLP) and speed (SLS) with just one barcode encoder
 - Safe monitoring (SLS and SLP) of up to three axes (travel, hoist, turn) in combination
 - Reliable communication between all EMSs and the stationary MOVISAFE®-HM31 controller using SEW-EURODRIVE slotted waveguides
 - SDM* (Safe Distance Monitoring) enables dynamic, safe increases in distance in assembly lines

* The panel of judges for the Handling Awards 2016 was impressed by SDM, awarding it second prize in the category "Quality and Safety"



Electrified monorail system – EMS advanced

- Intelligent drive control with absolute positioning
- Reliable WLAN communication
- Flexible, simple configuration with MOVIVISION®, because:
 - MOVIVISION® enables the simulation/emulation of the EMS system before startup
 - The Motion Profile Manager makes it easier to create and modify travel profiles for up to three axes (travel, hoist and turn)
 - Condition monitoring provides comprehensive diagnostics comparison of your EMS system at any time using the timeline function



Electrified monorail system – EMS basic

- Compact system solution for simple transportation tasks
- With half-wave control and configurable functions
- Cost-effective and robust
- Perfect for retrofits



Automated guided vehicle system (AGV)

- High flexibility without obstructing floor space
- Decentralized drive and positioning control using MOVIPRO® application inverter
- MOVITRANS® contactless energy transfer system
- Reliable WLAN communication



Skillet

- Intelligent, decentralized drive control using MOVIVISION® configurable system software
- Absolute positioning
- Reliable WLAN communication
- Contactless energy transfer
- Scalable safety functions (SLP, SLS for hoist, SLP for X-axis; reliable communication)

Any questions? Please do not hesitate to contact our experts:
Maxolution.Automotive@sew-eurodrive.de

Customized solutions for courier, express and parcel logistics and the airport industry – **reliable and efficient**

SEW-EURODRIVE is familiar with all requirements in courier, express and parcel logistics, as well as airport industry applications. From package and baggage transportation to sorting and distribution, our high-efficiency MOVIGEAR® mechatronic drive system and DRC.. electronic motor in combination with the decentralized MOVIFIT® FDC controller boost cost-effectiveness in all processes.

Drive solutions for baggage handling systems at airports

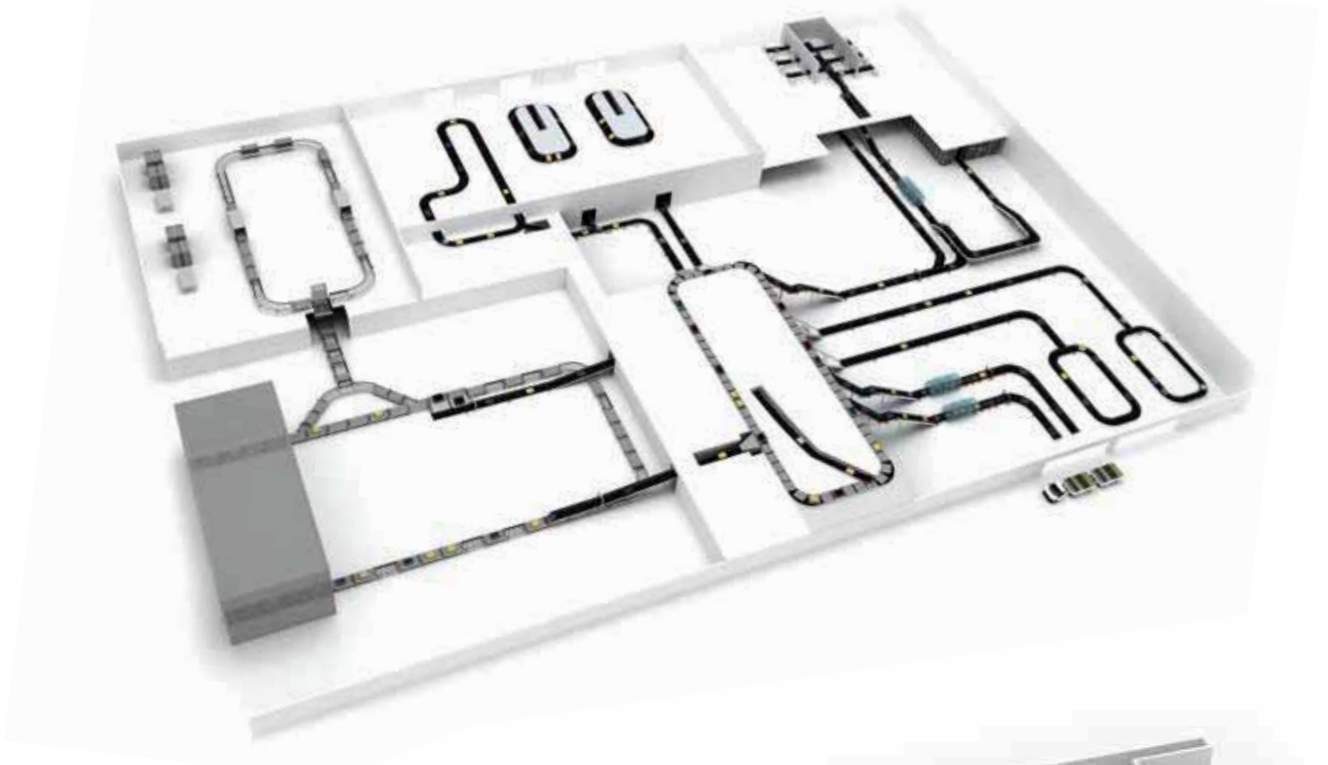

Drive solutions for package conveyor systems in logistics centers

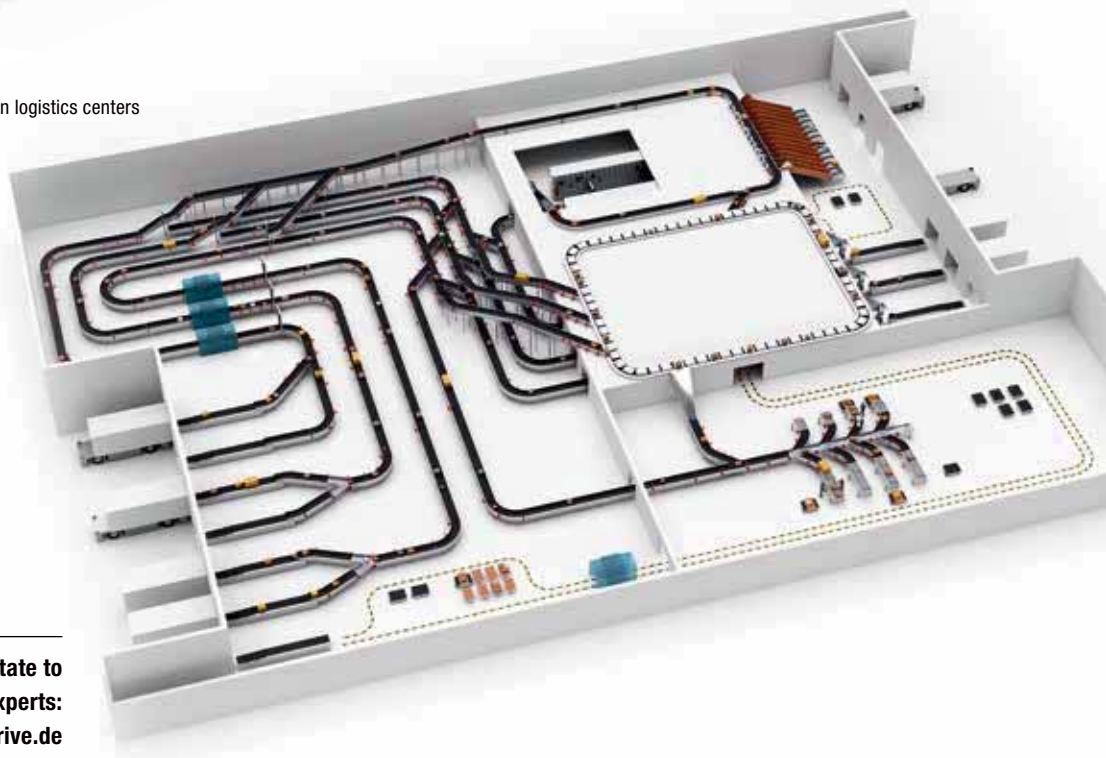

Any questions? Please do not hesitate to
contact our experts:
Maxolution.Airport@sew-eurodrive.de
Maxolution.Parcel@sew-eurodrive.de



Standard conveyors

Standard conveyor elements and curved conveyors can be implemented with optimized throughput and energy efficiency.

Your benefits

- A modular approach with up to 10 drives per infrastructure segment
- Quick installation and startup
- Simple diagnostics and drive exchange
- High-performance for efficient material flow

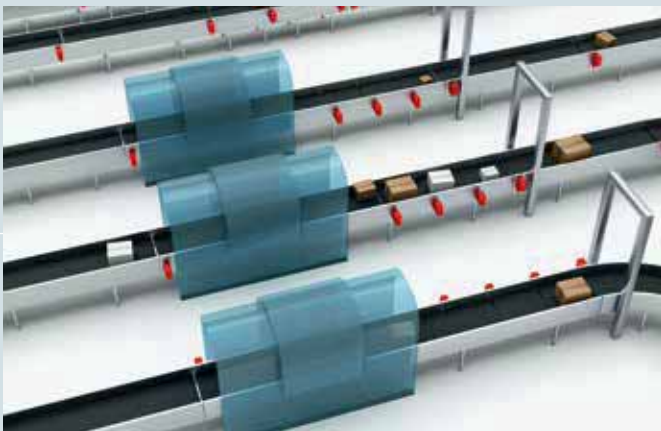

Package or baggage processing (gap control & tracking)

Optimizes the distance between individual items at machine entry, e.g. for scanning purposes (EDS or DWS machines)

- Optimized gap control
- Maximized throughput
- High energy savings
- Independent operation possible, e.g. in event of fault



Vertical distributors

Aid the distribution and collection of individual parts between two levels.

Your benefits

- Significant improvement of energy efficiency and throughput
- Reduced installation costs
- High-performance systems thanks to high drive functionality

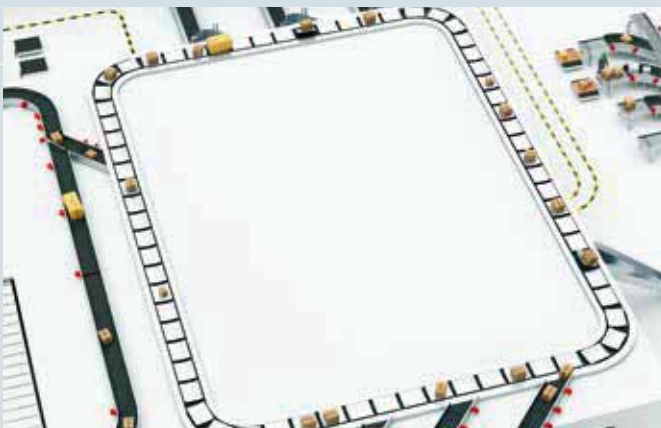

Sorters

Drive solutions from SEW-EURODRIVE in sorter applications ensure smooth, quiet and gentle operations and easy startup thanks to

- A module controller with load distribution function
- Drives without fans
- Modular and configurable solutions

Customized solutions for transport and warehouse logistics – innovative processes and flexibility for smart factories

SEW-EURODRIVE's many years of experience make it your perfect partner, especially when it comes to process consulting, including simulation, engineering and programming, all the way to implementation with installation and startup for smart factories.



Mobile transport vehicles

- Pallet, container and material transportation for machinery or assembly lines
- Wide range of infrastructure systems selected individually
- Complete engineering framework for vehicles and logistics coordination
- Energy management with contactless energy transfer, energy storage units or batteries
- Flexibility and dynamic options for processes, products and logistics
- Scalable navigation functions



Storage and retrieval system

- Complete automation structure with
 - Energy management with energy optimization
 - Motion and logic controller
 - Safety functions – Control of load handling device
- Complete automation of shuttle for pallets
- Direct interface with warehouse management system (WMS)



Pallet transfer shuttle

- Wear-free, contactless energy transfer
- Intelligent energy management
- Complete modular system covering everything from drives and controllers to the software framework

Customized solutions for the food and beverage industry – efficient and powerful

Whether disposable or returnable bottles, whether dry, wet or hygienic areas, and whether solid, liquid or bulk materials – SEW-EURODRIVE's customized MAXOLUTION® system solutions provide greater cost-effectiveness, flexibility and throughflow in the food and beverage industry.



Bottle and packaging unit transportation

- Specifically designed for use in food and drinks transportation plants
- IE4 motors deliver the highest possible energy efficiency class
- Encapsulated MOVIGEAR® drive system makes the cleaning process easier, even in inaccessible places
- MOVIGEAR® is an optimized mechatronic unit consisting of motor, gear unit and control electronics



Packers

- Overall functionality of the system based on modular automation system
- Open software platform for customized system design
- Heavy link-chain belts in the feed and removal processes for the crates of bottles are moved by compact MOVIGEAR® mechatronic units
- When required, the centering frame and the portal can be fitted with servo or standard gearmotors with encoders

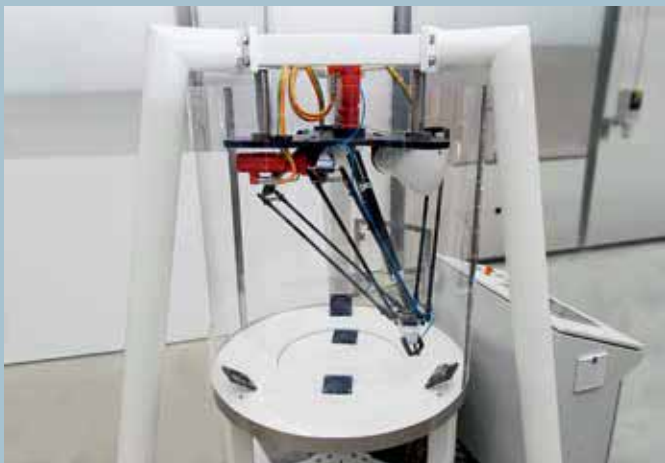

MAXOLUTION® Production Robots

- Open software platform for complete automation
- Customized system design in the shortest possible time based on tried-and-tested robot functionalities
- Available as a stand-alone machine or as a component
- Axes can be fitted with servo or standard gearmotors with encoders

Customized solutions for the food and beverage industry – packaging machines for secondary packaging

As a partner for end customers and OEMs, MAXOLUTION® makes it possible to design machine solutions in an extremely short period of time. Using the most innovative technology available and a toolbox of software modules based on PackML, new packaging systems can be quickly created and old systems modified to meet the goals of high throughflow with low energy consumption.



Input

- Efficient MGF1..DSM drive unit with an energy-efficiency class IE4 motor
- For conveyor applications with control cabinet installation
- Lower space requirements than gearmotor unit
- Less cleaning required thanks to hygienic product design
- Reduced noise levels



Packaging unit

- New MOVI-C® control platform enables modular and flexible structure for systems
- Overall functionality is created based on verified, customizable software modules available in the PackML-compatible SEW-EURODRIVE Automation Framework
- Templates available for visualization and control units
- Multi-axis servo modules for efficient system layouts



Output

- New SEW-EURODRIVE roller drive for simple conveyor tasks
- Ready-made solution for roller conveyors
- Includes software module for control



Cartoning machine with materials handling technology

Tailor-made success – system solutions for every movement.

Our MAXOLUTION® system solutions are just as unique as your ideas and requirements. A few insights will give you an indication of how and where the project-specific solutions are used, but a personal discussion is the best way to provide you with more detailed information and ideas with

regard to the support MAXOLUTION® can offer. No matter what your solution will look like: You will benefit from reduced complexity thanks to perfectly matched system components and consistency.



Individuality and many years of expertise all over the world

In addition to tailor-made system solutions, MAXOLUTION® also boasts a comprehensive, adaptable modular service concept. Thanks to our years of experience in providing system solutions for international projects, we have built

up a service portfolio that ensures the best solution to suit your requirements. The portfolio covers every phase of the product life cycle – from consulting, planning and engineering to implementation, startup and production monitoring.

We offer you a comprehensive solution geared to your specific needs and coordinated with our system solutions.

MAXOLUTION® modular service portfolio

Customized consulting / engineering

Customer-focused project management

Software Programming and startup

Training

Project-specific system modifications and testing

System and machine simulation

Emulation and virtual startup

Process simulation and visualization

Safety services

Energy consulting

Worldwide delivery logistics

Production monitoring



Further information about MAXOLUTION® system solutions is available here:
www.sew-eurodrive.de/added-value

NEW: We automate:
SEW-EURODRIVE can automate your machine
for your specific industry and application

As a manufacturer of machinery, you are sure to have come across SEW-EURODRIVE in the world of drive engineering and drive automation already. You have probably used our technology before – perhaps in the form of a mechatronic system.

Now it's time to go one step further. After all, in our industry and yours, the successful players are the ones who push themselves, enjoy taking on new challenges, never lag behind, and above all prove themselves as reliable partners.

We understand that machine automation requirements do not just vary from sector to sector. Even within one industry, a wide range of different, application-specific needs and expectations have to be taken into account.

Packaging machines, for instance, are by no means all the same, and sealing requirements for filling machines differ both from product to

product and from country to country. Ultimately, the end user determines what is needed for production. The cleaning process for the machinery depends on the type of food being filled; the coating for the drives depends on the cleaning process, and so on.

Meanwhile, when it comes to palletizers, palletizing robots or handling modules, these components are used for a wide range of different materials and loads and are needed for very different types of movement. Here, too, requirements for single-, double-, and multi-axis machinery and machine modules vary with virtually every application.

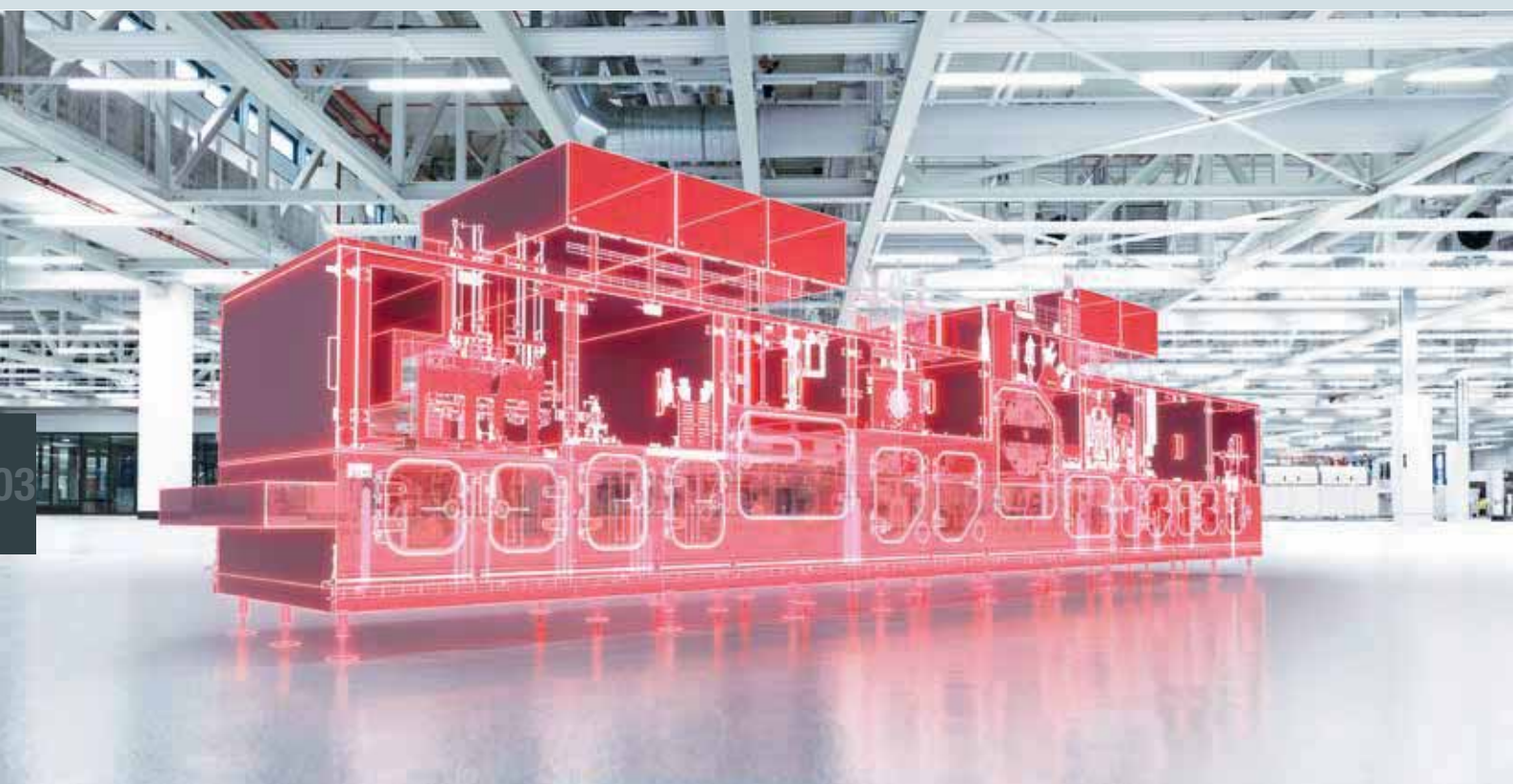



MAXOLUTION® Machine automation

Here's how it works: Our MAXOLUTION® system delivers machine automation solutions specific to your industry and application. We act as your partner from the very start and support you with planning and implementing your automation concept.

Your machine requirements are our top priority. This is why we only begin to discuss the relevant drive and automation technology and software once we have put our heads together to find you the best possible machine automation solution.

What can we achieve together?

We can speed up your time-to-market and boost machine efficiency while also maintaining high functional reliability. We can also accelerate the time it takes for your staff to familiarize themselves with the system and ensure that startup is as simple and innovative as possible.

What else?

- Lower maintenance costs
- Minimized startup and service times
- Faster engineering time
- Format adjustment without conversion
- No need for expensive tools
- Reduced complexity and number of variants
- Low total cost of ownership

And, of course, coordinating a range of different function modules is no more a problem for us than combining and automating different peripheries. On the contrary, we enjoy the challenge when we have to take into account a range of input and output interfaces in the material flow or system interfaces to other machine modules. We are also fully aware of the trend for machines becoming increasingly modular and of the ever-increasing need for factory networking.



With intelligent and communicative hardware and software – from mechanical drive level and inverter technology, including single-cable technology, right through to machine control – SEW-EURODRIVE opens up new perspectives for your machine automation. Our solutions feature a comprehensive safety concept and a high degree of connectivity. What's more, as a global player, we offer services all over the world. And we are also happy to discuss virtual solution and/or service concepts for your end customers.

As your partner for machine automation, we put all of our industry and application expertise at your disposal to ensure that you are able to find the best possible solutions for your automation requirements.

SEW-EURODRIVE – your partner for:

- Packaging machines in the food and beverage industry
- Machines in intralogistics
- Applications in robotics and handling
- Machines in the chemical and pharmaceutical industry

What level of automation do you require?
Contact us and we can discuss your needs!

AUTOMATION



Variety and high performance – our industrial gear units

Solutions for large-scale tasks. Our industrial gear units drive systems in a wide range of different industries. When high torque ratings are needed to carry out particularly large movements, we can supply the perfect industrial gear unit. No matter what your requirements are, we have the solution and can deliver it worldwide – either from our modular system or as a customized solution designed and developed to your specifications.

As individual as you choose

The experience we have gained through countless successful projects in a huge range of industries and different countries is at the heart of our series of industrial gear units. This includes our expertise in control technology, engineering tools, plant software, machine safety and energy efficiency.

We are constantly optimizing our solutions to meet your requirements and are the perfect partner to work with to implement the perfect solution for your needs.

The right solution for every industry



Cement industry

- Bucket elevator
- Ball mill (direct, girth gear)
- Rotary kiln
- Sifters
- Belt conveyors
- and much more



Mining industry

- Flotation cell
- Belt conveyors
- Crushers
- Apron feeders
- and much more



Port logistics

- Hoist drives
- Travel drives
- and many more



Food and beverage industry

- Mixers
- Dryers
- Spiral freezers
- Extruders
- and many more



Energy and environmental technology

- Cooling towers
- Shredders
- Helical conveyors
- Pump drives



Metal and steel industry – Drives for:

- Bulk material conveyors
- Mills and crushers
- Mixers
- Travel drives
- Cranes
- Continuous casters
- Roller tables
- Hot and cold rolling
- Processing lines
- Wire, tube and pipe manufacturing

What keeps the cement industry moving

Bucket elevator drives – intelligent combination

Requirement: A continuous conveyor system for vertically transporting bulk material in a bucket elevator.



Our solution:

- Bevel-helical gear units with solid or hollow shafts
- Auxiliary drive with free-running clutch and speed sensor
- Standardized solutions in 19 sizes
- High nominal torques from 6.8 to 270 kNm

Your benefits:

- All drive components perfectly matched
- Quick delivery time thanks to modular concept
- Quick startup

Ball mills – an efficient move

Requirement: Uniform movement of a horizontal cylinder filled with steel balls for pulverizing bulk material.



Our solutions:

Direct drive

- Helical or planetary gear unit with primary gear unit up to 5200 kNm
- Auxiliary drive with clutch
- Cooling systems
- Various couplings

Your benefits:

- Complete design of the mechanical drive train
- Drive solution from one source
- Compact design
- Straightforward delivery processing



Girth gear drive

- Multi-stage helical gear units up to 2500 kNm
- Girth gears in segmented design
- Oil cooling systems
- Heating systems
- Motors
- Various couplings (drive input and output side)
- Base frame

Your benefits:

- Maximum reliability
- Weight-optimized solution in segmented design
- Simplified handling thanks to segmented design, simplified logistics and assembly
- Long service life with compact dimensions



Increase container terminal handling capacity

Crane drives – reliability and high availability

Requirement: Moving and positioning the trolley and the container crane with travel drives; lifting and lowering the container with a hoist gear unit.



Our solutions:

Travel drives

- Standard drives from the modular gearmotor system or as
- Industrial gear units from the X modular system, optionally with motor, coupling, brake, motor scoop



Requirement: Secure, quick and low-vibration container movement

Hoist drive

- Industrial gear unit from the X system
- Bevel-helical gear unit, helical gear unit with standard or larger center distance, optional customer-specific solutions with motor, brake, coupling, etc.

Your benefits:

- Standard gear units, custom modified gear units or customer-specific solutions to suit connection dimensions
- Weight-optimized drives, reduced weight on trolley
- Energy savings on trolley and crane drives
- Smaller travel drives possible if necessary
- Lower investment costs thanks to lighter steel structure
- Quick delivery time
- High availability
- Invertible gear unit housing: Gear unit can be used in CW or CCW direction so only one replacement unit is required (lower investment and stocking costs)

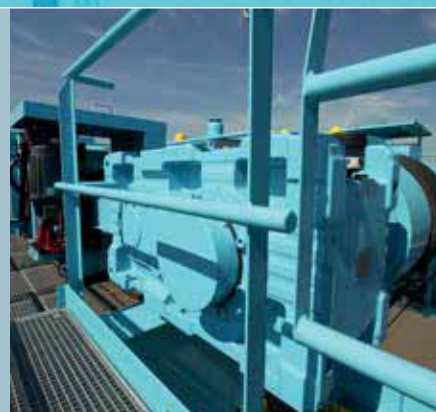

Which drive really causes a stir

Mixers and agitators – getting the right mix

Requirement: Uniform mixing and agitating of viscous to paste-like substances and absorption of high axial and radial process forces.





Our solution:

Agitator gear unit

- 2-, 3- and 4-stage helical and bevel-helical gear unit
- Torque range from 22 to 90 kNm, extended bearing distance
- Reinforced bearing concepts for absorbing high axial and radial forces
- Available in moderate duty, heavy duty radial, or heavy duty design depending on the load
- ATEX
- Drywell sealing for vertical mounting position
- Flange coupling
- Foot- or flange-mounting

Your benefits:

- Modular system (parts stocked)
- Quick delivery times
- Highly versatile
- Robust and functional design
- Monoblock housing with high stiffness
- High thermal rating
- Various sealing systems (Drywell sealing system as part of housing)
- Various bearing concepts for absorbing external process forces
- Shaft end pump integrated into housing
- Integrated oil expansion tank
- Cooling and heating options available
- Flange coupling available (key or shrink fit)

Distance is no obstacle

Belt conveyors – reliable even in harsh conditions

Requirement: Transporting material continuously over long distances and across large height differences in harsh ambient conditions

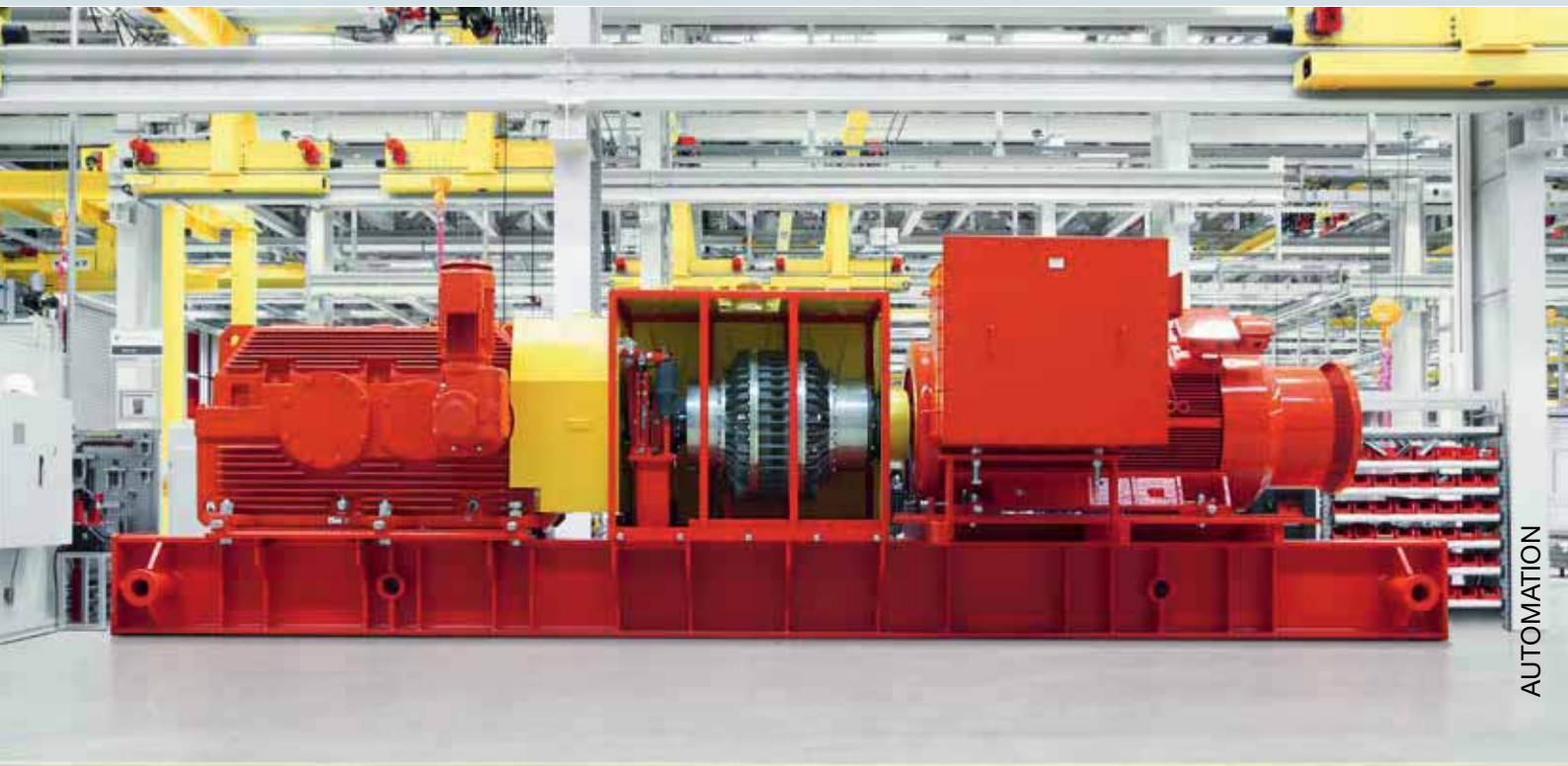

**Our solution:****Belt conveyors**

- Complete drive system from a single source
- Gear unit, coupling, brake, motor, swing base

Your benefits:

- Perfectly coordinated system components
- Exceptional dependability and operational reliability in harsh environments
- Customized solution concepts
- Comprehensive optional equipment available (ATEX)

Record-level performance – our drive concept for the new Zugspitze cable car

This mega-project has involved a total of six years of planning and construction work, and our drive technology has played a central role. The technical configuration of the main drives was undertaken by Alfred Imhof AG, the Swiss branch of SEW-EURODRIVE, in collaboration with cable car engineering market leader Garaventa. The solution uses two X3FS280 helical gear units with a nominal torque of 240 000 Nm and a maximum operating power of 1024 kW. The drive design is installed twice so that the system can continue to operate at maximum load with just one drive if necessary.

In the event of an emergency stop that brings the cable cars to a halt, passengers can be rescued with a separate car. The recovery drive for this car is also supplied by SEW-EURODRIVE, using an X3TH210 bevel-helical gear unit with a nominal torque of 90 000 Nm.



Requirement: Gear unit for the new Zugspitze cable car system. Improved comfort for Zugspitze visitors; reduced waiting times. Basic conditions: High-altitude site, weather conditions, height difference of 1945 meters in one section.

Three world records

The vehicles in the new cable car system operate in alternation and travel along two carrier cables. The cars are driven by a dual drive with a power

rating of 1700 kW. The track route and location of the upper and lower stations have remained largely unchanged. The new system is lapping up superlatives and lays claim to three cable car world records – the world's highest steel support for an aerial tramway at 127 meters; the largest total height difference at 1945 meters in one section; and the longest unsupported span at 3213 meters.



NEW: MODULAR AUTOMATION SYSTEM

The future of automation – in central and decentralized installations



Four modules – one solution: Complete automation from a single source:

- Using the MOVISUITE® engineering software saves you time and costs.
- The MOVI-C® CONTROLLER control technology reduces complexity.
- The MOVIDRIVE® inverter technology controls synchronous motors and asynchronous motors.
- The drive technology makes for proper movement in each application.





MOVI-C®



Modular automation system

Features and advantages

- MOVI-C® is the all-in-one solution for automation tasks no matter whether they are standardized single-axis or multi-axis applications or individual and/or particularly complex applications in the field of motion control or automation, and can be used both in centralized and decentralized installation concepts.
 - Four modules – one complete solution:
 1. Engineering software
 2. Control technology
 3. Central and decentralized inverter technology
 4. Drive technology
- With the MOVI-C® automation system, SEW-EURODRIVE delivers every automation component you need from a single source from the software for planning, startup and operation to electronic control components, mechanical drive and gearmotor. And each can naturally be fully integrated into all automation concepts.

Topologies/application examples

- The all-round modular system for any topology:
 - Single-axis automation, such as material transport
 - Motion control, such as multi-column hoists, tripod mechanisms, robots incl. auxiliary axes
 - Module automation, such as packaging machines, processing machines, complex transportation tasks (module automation)
 - EtherCAT® motion slave, for example series machines with many axes, kinematic calculation in the higher-level PLC

Engineering software



MOVISUITE®

Features

Save time and cut costs

- MOVISUITE® sets standards for engineering software in drive technology
- Significant time and cost savings due to faster engineering and unique usability: Planning, startup, operation and diagnostics are quicker and easier than ever before

MOVISUITE® standard

- End-to-end engineering for all components in the MOVI-C® modular automation system, from inverters to customer-specific drive technology
- Rapid engineering thanks to unique usability and optimized workflows
- User-friendly operation with a modern look and feel and state-of-the-art GUI technology
- Simple accessibility thanks to homogenized engineering interfaces
- Startup and parameter setting of MOVIDRIVE® modular and system application inverters
- Optimized workflows for professional and occasional users
- Quick and easy familiarization for users thanks to state-of-the-art interactive design
- Intuitive handling of inverter functions such as manual mode and startup of the drive train
- Configuration and creating IEC programs for MOVI-C® CONTROLLERS
- Parameter setting and diagnostics for MOVIKIT® software modules
- Efficient data management
- Integrated project management
- Network scan and display of devices
- Scope function
- Electronic catalog for SEW-EURODRIVE products
- Comprehensive context-sensitive help function

For help videos and the scope of the MOVISUITE® engineering software, go to:



MOVI-C®

Control technology hardware



MOVI-C® CONTROLLER

Advantages

Cut complexity

- The MOVI-C® CONTROLLER results in more flexible parameterization and less programming work
- Ready-made MOVIKIT® software modules are available for various applications
- Startup is performed using the MOVIRUN® software platform, which saves costs and reduces complexity; of course, own programs can also be written instead.
- Available in four performance classes: power, progressive, advanced, and standard
- Simple, central data management and auto reload function for axis replacement
- MOVI-C® CONTROLLER can be used with all common control systems

Features/equipment

- Straightforward and centralized data management
- Can be connected to all standard control systems
- High performance and user friendly
- Auto reload function for axis replacement
- Startup: MOVIRUN® software platform modules for parameterization or programming
- Operation: MOVIKIT® software modules, function blocks for simple speed control, positioning, robotics, electronic cam, mechanically coupled axes, etc.
- PROFIsafe routing to the axis modules
- 1x Ethernet (10/100 BaseT) for engineering or TCP/IP and UDP via IEC 61131-3
- 1x EtherCAT®/SBus^{PLUS} master

Performance class**MOVI-C® CONTROLLER standard**

- 1x CAN, non-isolated
- PROFINET slave, EtherNet/IP slave, Modbus TCP/IP slave
- Status display for PLC and fieldbus
- SD memory card
- ≤ 2 interpolating axes
- ≤ 6 auxiliary axes

Performance class**MOVI-C® CONTROLLER advanced**

- 2x CAN, 1 of which is electrically isolated
- 1x RS485
- PROFINET slave, EtherNet/IP slave, Modbus TCP/IP slave
- Status display for PLC and fieldbus
- Optional installation in a master module, can be added to MOVIDRIVE® modular
- SD memory card
- ≤ 8 interpolating axes
- ≤ 8 auxiliary axes

Performance class**MOVI-C® CONTROLLER progressive**

- PROFINET slave, EtherNet/IP slave, Modbus TCP/IP slave
- 2 GB CFast memory card
- ≤ 16 interpolating axes
- ≤ 16 auxiliary axes
- PC-based

Performance class**MOVI-C® CONTROLLER power**

- PROFINET slave, EtherNet/IP slave, Modbus TCP/IP slave
- 7x USB 2.0
- 2 GB CFast memory card
- ≤ 32 interpolating axes
- ≤ 32 auxiliary axes
- Second operating system, Windows Embedded 7, can be optionally connected via modern Hypervisor technology, e.g. for integrated visualization
- PC-based

MOVI-C®

Control technology software

Advantages

- High functionality and intuitive user interface
- Choose between parameter setting and programming
- Setting parameters instead of programming:
 - Startup shortened by using standardized software modules
 - Only parameters required for the application need to be entered
 - Guided parameter setting instead of complex programming
 - No lengthy familiarization, which means fast project planning and startup

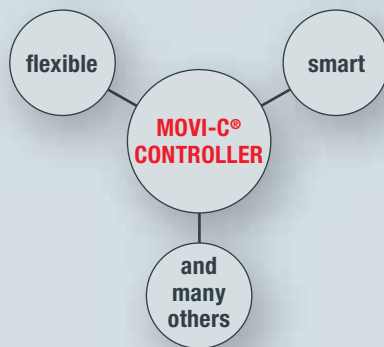

MOVIRUN® software platform for startup

Design MOVIRUN® flexible

- The open and flexible platform:
- Automation with MOVI-C® and third-party components
 - Interpolated operating modes for demanding motion control applications
 - State-of-the-art programming system (IEC61131)
 - Ready-to-use: MOVIKIT® software modules can be integrated into the user program

Design MOVIRUN® smart

- The intelligent, purely parameterizable motion control platform:
- Setting parameters instead of programming
 - Ready-to-use: MOVIKIT® software modules can be easily connected to higher-level controllers via the defined fieldbus interface
 - No additional programming work
 - Guaranteed, documented functionality

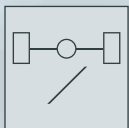

Gearing

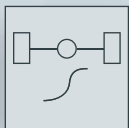

Camming

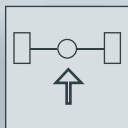

MAC

MOVIKIT® software modules
for operation

Features	For simple drive functions to challenging motion control functions <ul style="list-style-type: none"> – Graphic configuration and diagnostics – Available for MOVIDRIVE® technology, MOVIRUN® smart as purely parameterizable solution with fieldbus connection and MOVIRUN® flexible for integration in the IEC program with user-friendly IEC interface
Available software modules	<ul style="list-style-type: none"> – MOVIKIT® Velocity, Positioning – MOVIKIT® MultiMotion, MultiMotion Camming – MOVIKIT® MultiAxesController – MOVIKIT® Robotics – and much more

MOVI-C®

Inverter technology

MOVIDRIVE® application inverters

Features/equipment

One inverter series for all motors. They control and monitor:

- Synchronous and asynchronous AC motors with/without encoder
- Asynchronous motors with LSPM technology
- Synchronous and asynchronous linear motors

Available as

- Modular multi-axis system with single- and double-axis modules up to a rated current of 180 A
- Single-axis application inverter with line connection up to a rated power of 315 kW
- The application inverters also allow for operating explosion-proof motors

Explosion protection

MOVISAFE® functional safety

Functions in the basic unit

- STO (safe torque off)
- SIL 3 according to EN 61800-5-2, EN 61508
- PL e according to EN ISO 13849-1
- Can be activated via safe inputs
- Can be activated via safe communication if a CS..A safety card is plugged
- Extremely short response time of 2 ms enables short safety distances

For functions of the safety cards, see page 86.

Features of all types



- Multi-encoder input in the basic unit
- Torque-, speed- or position control
- EtherCAT®/SBus^{PLUS} in the basic unit
- State-of-the-art control modes for optimum control performance
- Can be used in TN, TT, IT networks
- IP20 degree of protection in all sizes
- Can be stored for extended periods without additional measures
- DC link port for connection to DC or regenerative power supply
- Easy startup using MOVIKIT® software modules
- Expansion for inputs and outputs, regenerative power supply, braking resistors, line choke, line filter, output choke, output filter

MOVIDRIVE® modular



Compact multi-axis system comprising power supply modules, regenerative power supply modules, single-axis and double-axis modules:

- Up to 30 drives for one power supply module
- Up to 800 m total motor line length
- Control via MOVI-C® CONTROLLER
- Particularly compact design
- Master module for compact integration of the MOVI-C® CONTROLLER
- Available as variant with EtherCAT® CiA402 profile

<p>MOVIDRIVE® system</p> 	<p>Single-axis application inverter with own power supply connection:</p> <ul style="list-style-type: none"> – Perfect addition to the multi-axis system for high power ratings or long motor cables – Up to 1200 m motor cable length – Control via MOVI-C® CONTROLLER – Available as variant with EtherCAT® CiA402 profile
<p>MOVIDRIVE® technology</p> 	<p>Single-axis application inverter with its own line connection and direct fieldbus connection via plug-in fieldbus interfaces. In addition to the features of MOVIDRIVE® system, MOVIDRIVE® technology offer:</p> <ul style="list-style-type: none"> – Startup via plug-in keypads or engineering software – Integrated memory card for saving device data – Integrated DC 24 V switched-mode power supply – Alphanumeric or fully-graphic keypad for starting up the application inverter and MOVIKIT® software modules

Technical data

	MOVIDRIVE® modular	MOVIDRIVE® system	MOVIDRIVE® technology
Nominal line voltage V	3x AC 380 – 500	3x AC 200 – 240 3x AC 380 – 500	
Nominal power of supply module kW	10 – 110	–	
Nominal power of regenerative power supply module, block-shaped kW	50 – 75	–	
Nominal output current – single-axis module A	2 – 180	–	
Nominal power kW	–	0.55 – 315	
Nominal output current – double-axis module A	2 – 8	–	
Overload capacity	250%	200%	
Overview of options	Multi-encoder input in the basic unit, encoder option for additional EtherCAT® interface, extension for inputs and outputs, regenerative power supply, braking resistors, line choke, line filter, output chokes		

MOVI-C®

Inverter technology





MOVISAFE® functional safety integrated in the inverter technology

Features	<ul style="list-style-type: none"> – MOVISAFE® functional safety integrated in the inverter technology STO in PL e already in the basic unit of MOVIDRIVE® – Higher quality safety functions: SS1, SS2, SOS, SLS, SSR, SSM, SLI, SLA, SDI, SBC pluggable option card – only functions that are needed are subject to a charge
Functions in the basic unit	<ul style="list-style-type: none"> – STO (safe torque off) – SIL3 according to EN 61800-5-2, EN 61508 – PL e according to EN ISO 13849-1 – Can be activated via safe inputs – Can be activated via safe communication if a CS..A safety card is plugged – Extremely short response time of 2 ms enables short safety distances
Pluggable option cards for high-quality safety functions	<p>Functions of the safety cards:</p> <ul style="list-style-type: none"> – Five scalable safety cards as appropriate to application requirements – Over 15 additional safety functions are possible by plugging option cards – Can be plugged-in later at any time, no additional external cables needed – Also with additional multi-encoder input – Safe communication via PROFIsafe/PROFINET and FSoE (Fail Safe over EtherCAT®) – Safety card parameters are included in the device data set – Can be easily replaced during servicing due to pluggable safety key on the safety card – Parameter setting and diagnostics using the MOVISUITE® engineering software – Process data and safety data in the same Scope recording – Safe output for activating functionally safe brake systems

Technical data

	MOVISAFE® CSB21A	MOVISAFE® CSB31A	MOVISAFE® CSS21A	MOVISAFE® CSS31A	MOVISAFE® CSA31A
Safe inputs	4	4	4	4	4
Safe outputs	–	2	2	2	2
Safe stop functions	STO, SS1c	STO, SS1c, SBC	STO, SS1c, SBC	STO, SS1c, SBC	STO, SS1c, SBC, SBT
Safe motion functions	–	–	SOS, SS1b, SS2, SLS, SSR, SLA, SSM	SOS, SS1b, SS2, SLS, SSR, SLA, SSM	SOS, SS1b, SS2, SLS, SSR, SLA, SSM
Safe position functions	–	–	SLI, SDI	SLI, SDI	SLI, SDI, SCA, SLP
Safe communication	PROFIsafe, FSoE	PROFIsafe, FSoE	PROFIsafe, FSoE	PROFIsafe, FSoE	PROFIsafe, FSoE
Additional multi-encoder input	–	yes	–	yes	yes

NEW: Decentralized drives and mechatronics

Features	<ul style="list-style-type: none"> – Perfect match of state-of-the-art drive engineering and automation technology including power electronics in a compact design – Saves time and effort for cabling and installation – Fast and simple startup 								
MOVIGEAR® performance 	<ul style="list-style-type: none"> – Fully integrated, compact design – Permanent magnet motor, gear unit and drive electronics are combined in a single mechatronic drive unit <p>MOVIGEAR® performance is available in two sizes and three power classes:</p> <table border="0" style="width: 100%;"> <tr> <td style="width: 30%;">MGF..2-xxxC</td> <td>Torque class: 200 Nm, nominal power of up to 0.8 kW</td> </tr> <tr> <td>MGF..4-xxxC</td> <td>Torque class: 400 Nm, nominal power of up to 1.5 kW</td> </tr> <tr> <td>MGF..4-xxxC/XT</td> <td>Torque class: 400 Nm with increased continuous torque, up to a nominal power of 2.1 kW</td> </tr> </table> <p>Control variants</p> <ul style="list-style-type: none"> – DFC – Direct fieldbus control (PROFINET, EtherNet/IP™, Modbus TCP, POWERLINK) – DSI – Direct system bus installation (EtherCAT®, SBus^{PLUS}) <p>In preparation:</p> <ul style="list-style-type: none"> – DBC – Direct binary communication – DAC – Direct AS interface communication – SNI – Single line network installation 	MGF..2-xxxC	Torque class: 200 Nm, nominal power of up to 0.8 kW	MGF..4-xxxC	Torque class: 400 Nm, nominal power of up to 1.5 kW	MGF..4-xxxC/XT	Torque class: 400 Nm with increased continuous torque, up to a nominal power of 2.1 kW		
MGF..2-xxxC	Torque class: 200 Nm, nominal power of up to 0.8 kW								
MGF..4-xxxC	Torque class: 400 Nm, nominal power of up to 1.5 kW								
MGF..4-xxxC/XT	Torque class: 400 Nm with increased continuous torque, up to a nominal power of 2.1 kW								
MOVIGEAR® classic (in preparation) 	<ul style="list-style-type: none"> – Integrated, compact design – Drive unit consisting of gear unit and permanent magnet synchronous motor <p>MOVIGEAR® classic is available in three sizes and four power classes:</p> <table border="0" style="width: 100%;"> <tr> <td style="width: 30%;">MGF..1-DSM-C</td> <td>100 Nm torque class; nominal power of up to 0.4 kW</td> </tr> <tr> <td>MGF..2-DSM-C</td> <td>200 Nm torque class; nominal power of up to 0.9 kW</td> </tr> <tr> <td>MGF..4-DSM-C:</td> <td>400 Nm torque class; nominal power of up to 2.1 kW</td> </tr> <tr> <td>MGF..4/XT-DSM-C:</td> <td>400 Nm torque class with increased continuous torque; Nominal power of up to 2.1 kW</td> </tr> </table> <p>Can be implemented in combination with the new application inverters MOVIDRIVE® modular, MOVIDRIVE® system and MOVIDRIVE® technology, or with the new decentralized inverter MOVIMOT® flexible of the new modular MOVIC® automation system.</p>	MGF..1-DSM-C	100 Nm torque class; nominal power of up to 0.4 kW	MGF..2-DSM-C	200 Nm torque class; nominal power of up to 0.9 kW	MGF..4-DSM-C:	400 Nm torque class; nominal power of up to 2.1 kW	MGF..4/XT-DSM-C:	400 Nm torque class with increased continuous torque; Nominal power of up to 2.1 kW
MGF..1-DSM-C	100 Nm torque class; nominal power of up to 0.4 kW								
MGF..2-DSM-C	200 Nm torque class; nominal power of up to 0.9 kW								
MGF..4-DSM-C:	400 Nm torque class; nominal power of up to 2.1 kW								
MGF..4/XT-DSM-C:	400 Nm torque class with increased continuous torque; Nominal power of up to 2.1 kW								
Announcement: MOVIMOT® flexible 	<ul style="list-style-type: none"> – Decentralized inverter – For installing drive electronics close to the motor – Can be combined with synchronous/asynchronous drives (with/without encoder) <p>Decentralized MOVIMOT® flexible (MMF.) inverters are available with a nominal current of 2 to 5.5 A for asynchronous motors with a nominal power of 0.55 to 2.2 kW</p> <p>Control variants</p> <ul style="list-style-type: none"> – DFC – Direct fieldbus control (PROFINET, EtherNet/IP™, Modbus TCP, POWERLINK) – DSI – Direct system bus installation (EtherCAT®, SBus^{PLUS}) <p>In preparation:</p> <ul style="list-style-type: none"> – DBC – Direct binary communication – DAC – Direct AS interface communication – SNI – Single line network installation 								

MOVI-C®

Inverter technology



Digital motor integration

Features

A digital data line turns the motor into a station in the data network. The motor provides any motor data, such as encoder data, temperature data, startup data, and data of other sensors, to the application inverters and the connected networks at any time. This information can be used to capture detailed operational data and compile maintenance forecasts.

Advantages

Digital motor integration

- Intelligent, digital connection with just one standardized hybrid cable for data connection and power supply between the motors (synchronous and asynchronous) and the application inverters:
 - The data line is linked to the application inverter using a series-standard coaxial connector
 - Plug connector on the motor or field-terminated connection in the terminal box

Available for motors up to size 315

- Extremely robust, high-performance data transmission with coaxial data line, ideal for compact installations
- Also suitable for extremely long cables measuring up to 200 m
- Fully integrated digital motor encoder in various designs
- Data memory in the motor for drive and application data, auto startup of the application inverter without engineering tool
- **NEW:** MOVILINK® DDI digital data interface for transferring
 - Electronic nameplate information
 - Brake and diagnostic data (e.g. temperature sensor data)
 - Encoder data, safe and non-safe
- **NEW:** Brake control integrated in the motor for synchronous and asynchronous motors:
 - For holding brakes and working brakes
 - No brake control unit required in the control cabinet
 - Permanent electronic sensing of switching state and brake wear
 - Transmission of brake diagnostics data to the application inverter via data interface
 - Condition-based maintenance intervals, forward planning of maintenance work, wear information, even for drives that are difficult to access

MOVI-C®

Drive technology



Motion solutions for every application

Features

Diversity centered around applications – that is what it's all about. Select standard and servo gear units in various sizes and designs and with different ratings, torques and finishes – combined with asynchronous or synchronous AC motors. Linear motors, electric cylinders, brakes, built-in encoders and diagnostic units complete this wide-ranging portfolio. Naturally, the products have all the necessary worldwide approvals.

NEW: Digital motor integration with single-cable technology: Standardized hybrid cable with uniform plug connector for synchronous and asynchronous motors alike (see from page 148)

Standard gear units

5 standard gear unit series:

- 1-, 2-, 3-stage helical gear units, R series: Output torque 50 Nm – 18000 Nm
- 2- and 3-stage parallel-shaft helical gear units, F series: Output torque 130 Nm – 18000 Nm
- 2- and 3-stage helical-bevel gear units, K series: Output torque 80 Nm – 50000 Nm
- 2-stage helical-worm gear units, S series: Output torque 92 Nm – 4000 Nm
- 1- and 2-stage right-angle gear units, W series: Output torque 25 Nm – 180 Nm
- Other than a few exceptions, the standard gear units are also available as compound gear units

Servo gear units

2 servo gear unit series:

- Low backlash planetary servo gear units, PS.F series:
Nominal torque 25 Nm – 3000 Nm
PS.C: Nominal torque 30 Nm – 320 Nm
- Low-backlash helical-bevel BS.F servo gear units:
Nominal torque 40 Nm – 1200 Nm

Motors

- DR.. and DT56 series AC motors (1 speed), 2-, 4- and 6-pole and
- Pole-changing DR.. series AC motors (2 speeds)

cover outputs from 0.09 kW to 225 kW and meet energy efficiency classes from IE1 to IE4

Also available: Torque motors, single-phase motors, aseptic motors and motors with explosion protection

- Synchronous and asynchronous servomotors for highly dynamic requirements, also with explosion protection
- and linear motors and electric cylinders complete the modular motor system.

Combined with a wide range of brakes, encoders, plug connectors, forced cooling fans, special coatings and surface treatments, the modular system has the ideal drive for your application.



Technical details of

standard gear units: Pages 120 – 125

Servo gear units: Pages 128 – 130

AC motors page: 148 – 151

Servomotors page: 166 – 169

OUR PRODUCTS

TAKING FLEXIBILITY TO A WHOLE NEW LEVEL.
OUR INNOVATIVE PRODUCTS
FROM THE UNIQUE MODULAR SYSTEM.





Fast – up-to-date – online:
Product information



Gearmotors page 94

Gear units page 118

Motors page 146

Industrial gear units page 196

Decentralized drives / mechatronics page 214

Inverter technology page 242

Servo drive technology page 280

Industrial communication page 282

Control technology page 294

Software page 308

Safety technology page 320

Contactless energy transfer system page 340

Didactics modules page 350

01 GEARMOTORS

1.1 Standard gearmotors

Helical gearmotors, RX../R..DR.. series	96
Parallel-shaft helical gearmotors, F..DR.. series	97
Helical-bevel gearmotors, K..DR.. series	97
Helical-worm gearmotors, S..DR.. series	98
SPIROPLAN® right-angle gearmotors, W..DR.. series	99

1.2 **NEW:** Gearmotors for agitators and mixing plants

Helical gearmotors, RM.. series	100
Helical-bevel gearmotors, KM../KAM.. series	100
Parallel-shaft helical gearmotors, FM../FAM.. series	101

1.3 Electrified monorail system gearmotors

Light loads, HW series	102
Heavy loads, HK series	103

1.4 Variable speed gearmotors

VARIBLOC® (wide V-belt)	104
VARIMOT® (friction disks)	105

1.5 Servo gearmotors

Planetary servo gearmotors, PS.F..CMP../PS.C..CMP.. series	106
Helical-bevel servo gearmotors, BS.F..CMP.. series	107
Precision servo gearmotors, ZN..CMP(Z).. / ZN..CM.. series	108
Helical servo gearmotors, RX../R..CMP.. series	109
Parallel-shaft helical servo gearmotors, F..CMP.. series	110
Helical-bevel servo gearmotors, K..CMP.. series	111
Helical-worm servo gearmotors, S..CMP.. series	112
SPIROPLAN® right-angle gearmotors, W..CMP.. series	113

1.6 Stainless steel gearmotors

Helical gearmotors RES.. series	114
Helical-bevel gearmotors, KES.. series	114

1.7 Explosion-proof gearmotors

Helical gearmotors, RX../R..EDR.. series	115
Parallel-shaft helical gearmotors, F..EDR.. series	115
Helical-bevel gearmotors, K..EDR.. series	115
Helical-worm gearmotors, S..EDR.. series	115
SPIROPLAN® right-angle gearmotors, W..EDR.. series	116
Planetary servo gearmotors, PS.F..CMP.. series	116
Helical-bevel servo gearmotors, BS.F..CMP.. series	117
Helical servo gearmotors, R..CMP.. series	117
Parallel-shaft helical servo gearmotors, F..CMP.. series	117
Helical-bevel servo gearmotors, K..CMP.. series	117
Helical-worm servo gearmotors, S..CMP.. series	117
SPIROPLAN® right-angle gearmotors, W..CMP.. series	117

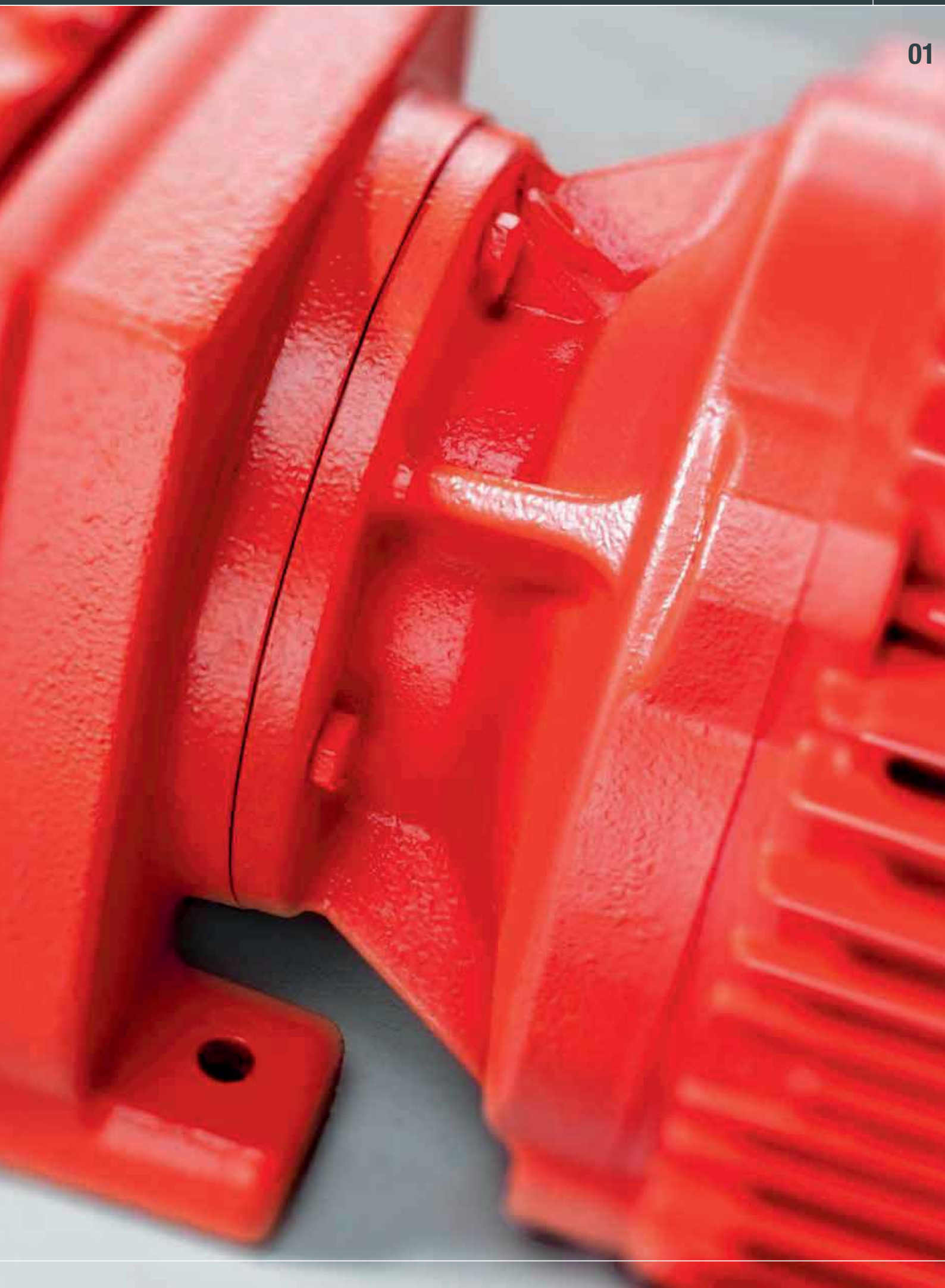

1.1 Standard gearmotors

Helical gearmotors



RX series (one stage)

Gear unit		Motor	
Gear unit sizes	M_{amax} gear unit Nm	Energy efficiency class	Power rating kW
RX57 – RX107	69 – 830	IE1, with 4-pole DR2S../DRS.. motor	0.12 – 55
		IE2, with 4-pole DRE.. motor	0.37 – 45
		IE3, with 4-pole DRN.. motor	0.12 – 55
		IE4, with 4-pole DRU.. motor	0.18 – 3



R series (two and three stages)

Gear unit		Motor	
Gear unit sizes	M_{amax} gear unit Nm	Energy efficiency class	Power rating kW
R07 – R167	50 – 20 000	IE1, with 4-pole DR2S../DRS.. motor	0.09 – 200
		IE2, with 4-pole DRE.. motor	0.37 – 200
		IE3, with 4-pole DRN.. motor	0.12 – 200
		IE4, with 4-pole DRU.. motor	0.18 – 3

Parallel-shaft helical gearmotors



F series (two and three stages)

Gear unit		Motor	
Gear unit sizes	M_{amax} gear unit Nm	Energy efficiency class	Power rating kW
F27 – F157	130 – 20 000	IE1, with 4-pole DR2S../DRS.. motor	0.12 – 200
		IE2, with 4-pole DRE.. motor	0.37 – 200
		IE3, with 4-pole DRN.. motor	0.12 – 200
		IE4, with 4-pole DRU.. motor	0.18 – 3

Helical-bevel gearmotors



K series (two stages / three stages)

Gear unit		Motor	
Gear unit sizes	M_{amax} gear unit Nm	Energy efficiency class	Power rating kW
K19 – K187	80 – 53 000	IE1, with 4-pole DR2S../DRS.. motor	0.12 – 200
		IE2, with 4-pole DRE.. motor	0.37 – 200
		IE3, with 4-pole DRN.. motor	0.12 – 200
		IE4, with 4-pole DRU.. motor	0.18 – 3

1.1 Standard gearmotors

Helical-worm gearmotors



S series (two stages)

Gear unit		Motor	
Gear unit sizes	M_{amax} gear unit Nm	Energy efficiency class	Power rating kW
S37 – S97	92 – 4 000	IE1, with 4-pole DR2S../DRS.. motor	0.12 – 45
		IE2, with 4-pole DRE.. motor	0.37 – 45
		IE3, with 4-pole DRN.. motor	0.12 – 37

SPIROPLAN® right-angle gearmotors



W series (one stage / two stages)

Gear unit		Motor	
Gear unit sizes	M_{amax} gear unit Nm	Energy efficiency class	Power rating kW
W10 – W47	25 – 180	IE1, with 4-pole DR2S../DRS.. motor	0.09 – 5.5
		IE2, with 4-pole DRE.. motor	0.37 – 4
		IE3, with 4-pole DRN.. motor	0.12 – 4
		IE4, with 4-pole DRU.. motor	0.18 – 2.2

- ➔ **Accessories and options for standard gearmotors:**
- Surface and corrosion protection: pages 138 – 140
 - TorqLOC® hollow shaft mounting system: page 141
 - Oil condition monitoring and vibration analysis: pages 142 – 145
 - Premium Sine Seal oil seal: pages 194 – 195

1.2 **NEW:** Gearmotors for agitators and mixing plants

Helical gearmotors



RM.. series (two and three stages)

Gear unit		Motor	
Gear unit sizes	M_{amax} gear unit Nm	Energy efficiency class	Power rating kW
RM57 – RM167	450 – 20 000	IE1, with 4-pole DR2S../DRS.. motor	0.12 – 200
		IE2, with 4-pole DRE.. motor	0.37 – 200
		IE3, with 4-pole DRN.. motor	0.12 – 200
		IE4, with 4-pole DRU.. motor	0.18 – 3

Parallel-shaft helical gearmotors



FM../FAM.. series (two and three stages)

Gear unit		Motor	
Gear unit sizes	M_{amax} gear unit Nm	Energy efficiency class	Power rating kW
FM67 – FM157	820 – 20 000	IE1, with 4-pole DR2S../DRS.. motor	0.12 – 200
		IE2, with 4-pole DRE.. motor	0.37 – 200
		IE3, with 4-pole DRN.. motor	0.12 – 200
		IE4, with 4-pole DRU.. motor	0.18 – 3

Helical-bevel gearmotors



KM../KAM.. series (three stages)

Gear unit		Motor	
Gear unit sizes	M_{amax} gear unit Nm	Energy efficiency class	Power rating kW
KM57 – KM157	820 – 20 000	IE1, with 4-pole DR2S../DRS.. motor	0.12 – 200
		IE2, with 4-pole DRE.. motor	0.37 – 200
		IE3, with 4-pole DRN.. motor	0.12 – 200
		IE4, with 4-pole DRU.. motor	0.18 – 3

→ Accessories and options for gearmotors for agitators and mixing plants:

- Surface and corrosion protection: pages 138 – 140
- Oil condition monitoring and vibration analysis: pages 142 – 145
- Premium Sine Seal oil seal: pages 194 – 195

1.3 Electrified monorail system gearmotors

HW series – light load range



HW series

Features	<ul style="list-style-type: none"> – Compliance with the standards of the C1 Directive (VDI RL-3643) – Low maintenance – Smooth running for operation without vibration – Low-noise, also suitable for manual work stations – Compact design for space-saving installation 	
Size	HW10	HW30
Maximum output torque Nm	20	70
Permitted wheel load N	2 500	5 600
Gear ratio i	6.75 – 16.5	8.2 – 75
Shaft d × l mm	14 × 28	20 × 35 25 × 35

HK series – heavy load range



HK series

Features

- High efficiency due to the helical-bevel gear unit
- Low energy consumption in connection with the MOVITRANS® contactless energy transfer system
- Can be switched safely thanks to coupling in the gear unit output stage

Size	HK37	HK40	HK50	HK60
Maximum output torque Nm	220	400	600	820
Permitted wheel load N	14 500	18 500	25 000	40 000
Gear ratio i	13.08 – 106.38	12.2 – 131.87	13.25 – 145.14	13.22 – 144.79
Shaft d × l mm	25 × 35	30 × 60 35 × 70	45 × 90	55 × 110

→ Accessories and options for electrified monorail system gearmotors:

- Surface and corrosion protection: pages 138 – 140
- Premium Sine Seal oil seal: pages 194 – 195

1.4 Variable speed gearmotors

Wide V-belt variable speed gearmotors



VARIBLOC®

Wide V-belt variable speed gearmotors

Features

- U-shaped or Z-shaped power flow
- Several combination options with reduction gear units
- Easy adaptation to a wide variety of machine designs
- The foot-mounted and flange-mounted designs can also be used without reduction gear unit as machine drive
- Can be combined with motors of the DR.. series
- Flexible due to finely stepped gear ratio ranges of the reduction gear units per size
- Easy to operate with handwheel or remote control

VARIBLOC® Size	Max. motor power 4-pole			Possible power flow	Max. setting range for design	
	DRS.. kW	DRE.. kW	DRN.. kW		Ventilated	Non-ventilated
VU / VZ 01	0.55	–	0.75	U + Z	1:6	–
VU / VZ 11	1.1	0.75	1.5	U + Z	1:8	1:6
VU / VZ 21	3	2.2	3	U + Z	1:8	1:6
VU / VZ 31	5.5	4	4	U + Z	1:8	1:6
VU / VZ 41	11	9.2	–	U + Z	1:6	1:4
VU 51	22	22	–	U only	1:6	–
VU 6	45	45	–	U only	1:4	–

Friction disk variable speed gearmotors



VARIMOT®

Friction disk variable speed gearmotors

Features

- The contact pressure between the drive pulley and the friction ring required for torque transmission is set automatically
- The speed can be adjusted even at standstill
- The foot-mounted and flange-mounted designs can also be used without reduction gear unit as machine drive
- Can be combined with motors of the DR.. series
- Flexible due to finely stepped gear ratio ranges of the reduction gear units per size
- Easy to operate with handwheel or remote control

VARIMOT® Size	Max. motor power kW	Max. setting range
D16	1.1	1:5
D26	2.2	1:5

- ➔ **Accessories and options for variable speed gearmotors:**
- **Surface and corrosion protection: pages 138 – 140**

1.5 Servo gearmotors

Planetary servo gearmotors



PS.F. series

with	Torque range M_{aDyn} Nm	PS.F. gear unit sizes
CMP.. motor (high dynamics)	15 – 4 200	PS.F121 – PS.F922
CM.. motor (high inertia)	49 – 4 200	PS.F321 – PS.F922



PS.C.. series

with	Torque range M_{aDyn} Nm	PS.C.. gear unit sizes
CMP.. motor (high dynamics)	15 – 425	PS.C221 – PS.C622
CM.. motor (high inertia)	49 – 425	PS.C321 – PS.C622

Helical-bevel servo gearmotors



BS.F. series

with	Torque range M_{aDyn} Nm	BS.F. gear unit sizes
CMP.. motor (high dynamics)	15 – 1 680	BS.F202 – BS.F802
CM.. motor (high inertia)	46 – 1 680	BS.F302 – BS.F802

1.5 Servo gearmotors

Precision servo gearmotors



ZN.. series

Features

- Extreme precision
- High overload capacity
- Sturdy bearings
- High power density
- Delivered with lifetime lubrication

Gear unit type	Servomotor CMP(Z)..*	Servomotor CM..	Gear ratio i	M_{amax} (5 rev/ min) Nm	M_{apk} Nm	$M_{aEmerg.Off}$ Nm	Torsional stiffness Nm/ arcmin	Pull-out rigidity Nm/ arcmin	Perm. pull-out torque Nm	Outer dia- meter mm
ZN..30	50S – 63M		41 – 164.08	341	612	1 225	61	530	784	133
ZN..40	50S – 71M	71S – 71L	41 – 164.08	573	1 029	2 058	113	840	1 660	159
ZN..50	50M – 80L	71S – 90L	41 – 161	834	1 500	3 000	200	1140	2 000	183
ZN..60	50M – 80M	71S – 90L	41 – 171	1090	1 960	3 920	212	1190	2 150	189
ZN..70	63M – 80M	71M – 90L	41 – 161	1390	2 500	5 000	312	1 400	2 700	208
ZN..80	63L – 80L	71L – 90L	41 – 161	1 703	3 062	6 125	334	1 600	3 430	221
ZN..90	63L – 112L	71L – 112L	41 – 201	2 225	4 000	8 000	490	2 050	4 000	238
ZN..100	71L – 112L	90M – 112H	75 – 185	5 178	9 310	18 620	948	5 200	7 050	295
ZN..110	80L – 112L	112S – 112H	81 – 192.75	6 813	12 250	24 500	1 620	6 850	11 000	325
ZN..120	80L – 112L	112S – 112H	105 – 203.53	9 733	17 500	35 000	2 600	9 000	15 000	395
ZN..130	80L – 112L	112S – 112H	185	12 514	22 500	45 000	3 685	11 790	25 480	440
ZN..140	80L – 112L	112S – 112H	156 – 236	20 460	36 788	73 575	6 320	25 000	44 000	570

* CMPZ.. is available in sizes 71 to 100.

Helical servo gearmotors



RX / R series

Features	<ul style="list-style-type: none"> – The RX57 to RX107 single-stage gear unit series offers compact, space-saving solutions for high output speeds – Thanks to the die-cast aluminum design, multi-stage gear units R07, R17 and R27 are ideal for use as satellite drives and for use in light machine constructions 					
	Synchronous servo gearmotors				Asynchronous servo gearmotors	
	with CMP.. motor (high dynamics)		with CM.. motor (high inertia)		with DRL.. motor	
Gear unit sizes	RX57 – RX77	R07 – R127	RX57 – RX107	R27 – R127	RX57 – RX107	R17 – R167
Gear ratios i	1.3 – 7.63	3.21 – 216.54	1.3 – 8.23	3.37 – 216.28	1.3 – 8.23	3.37 – 255.71
Torque range M_{aDyn} Nm	6.6 – 1 120	12 – 6 000	63 – 830	45 – 6 000	63 – 830	45 – 20 000
Rotational clearance (/R option) ,	–	5 – 14	–	5 – 14	–	5 – 14

1.5 Servo gearmotors

Parallel-shaft helical servo gearmotors



F series

Features	– This compact gearmotor not only excels by its performance but also by its structural properties		
	Synchronous servo gearmotors		Asynchronous servo gearmotors with DRL.. motor
	with CMP.. motor (high dynamics)	with CM.. motor (high inertia)	
Gear unit sizes	F27 – F107	F27 – F107	F27 – F157
Gear ratios <i>i</i>	3.77 – 276.77	3.77 – 276.77	3.77 – 276.77
Torque range M_{aDyn} Nm	15 – 8 860	67 – 8 860	87 – 20 000
Rotational clearance (/R option) ,	5 – 12	5 – 12	5 – 12

Helical-bevel servo gearmotors



K series

Features	<ul style="list-style-type: none"> – Helical-bevel gear units from SEW-EURODRIVE provide a high degree of efficiency in both torque directions and at any input speed – The gearing is designed for high endurance and makes for a high-torque, wear-free drive – The remarkably high efficiency of our helical-bevel gearmotors makes them energy-savers – The long maintenance-free service life is another reason why they can be used with AC asynchronous motors, asynchronous and synchronous servomotors in every application
-----------------	--

	Synchronous servo gearmotors		Asynchronous servo gearmotors with DRL.. motor		
	with CMP. motor (high dynamics)	with CM.. motor (high inertia)			
Gear unit sizes	K37 – K107	K..19 – K..49	K37 – K107	K37 – K187	K..19 – K..49
Gear ratios i	3.98 – 174.19	2.8 – 75.0	3.98 – 176.05	3.98 – 179.86	2.8 – 75.20
Torque range M_{aDyn} Nm	15 – 9 090	16 – 605	63 – 9 090	125 – 53 000	54 – 605
Rotational clearance (/R option)	5 – 13	–	5 – 13	5 – 13	–

1.5 Servo gearmotors

Helical-worm servo gearmotors



S series

Features

- Particularly space-saving when used as angular drive
- The attenuation characteristics are another advantage
- Torque shocks are attenuated as the power transmission to the drive shaft is linear on the input shaft
- The noise level of this type is very low, even when operating the unit at full capacity
- Can be used in stage lifts, for example

	Synchronous servo gearmotors		Asynchronous servo gearmotors with DRL.. motor
	with CMP. motor (high dynamics)	with CM.. motor (high inertia)	
Gear unit sizes	S37 – S67	S37 – S67	S37 – S67
Gear ratios i	3.97 – 75.06	6.80 – 75.06	3.97 – 75.06
Torque range M_{aDyn} Nm	18 – 580	43 – 480	32 – 480

SPIROPLAN® right-angle servo gearmotors



W series

Features

- SPIROPLAN® right-angle servo gearmotors with directly mounted synchronous CMP.. servomotor are extremely efficient, quiet, and offer customers the greatest possible flexibility
- SPIROPLAN® right-angle gear units W37/W47 achieve high speeds at smallest gear ratios
- Wear-free gearing minimizes friction losses and optimizes the mechanical efficiency
- Areas of application: ideal drives for simple positioning or conveyor applications
- Gear unit designs:
 - Foot/flange-mounted design
 - B5 flange
 - B14 flange
 - Solid shaft/hollow shaft
 - Directly mounted servomotor
 - Adapter mounting

	Synchronous servo gearmotors		Asynchronous servo gearmotors with DRL.. motor
	with CMP.. motor (high dynamics)	with CM.. motor (high inertia)	
Gear unit sizes	W10 – W47	W37 – W47	W37 – W47
Gear ratios i	3.2 – 75	3.2 – 51.12	3.2 – 74.98
Torque range M_{abyn} Nm	11 – 215	49 – 215	16 – 215

→ Accessories and options for servo gearmotors:

- Surface and corrosion protection: pages 138 – 140
- TorqLOC® hollow shaft mounting system: page 141
- Oil condition monitoring and vibration analysis: pages 142 – 145
- Premium Sine Seal oil seal: pages 194 – 195

1.6 Stainless steel gearmotors



Features of stainless steel gear units	<ul style="list-style-type: none"> – For use in areas subject to frequent cleaning – High-quality stainless steel is used – Efficiency-optimized gear units – Easy-to-clean surface thanks to special housing design – Low maintenance with long service life – High grade resistance to acid and alkaline – Recesses where dirt and liquid can accumulate were eliminated as far as possible 	
Type	KES37	RES37
Max. output torque Nm	200	200
Gear unit ratio i	3.98 – 106.38	3.41 – 134.83
Features of stainless steel gearmotors	<ul style="list-style-type: none"> – Compact, space-saving design as gearmotor for direct mounting – The entirely stainless steel design efficiently prevents all forms of corrosion – The design without fan allows for easy and reliable cleaning of the directly mounted stainless steel motors 	
Motor power range kW	0.37 – 0.75 (higher power ratings for adapter mounting are available on request)	

- ➔ **Accessories and options for stainless steel gearmotors:**
- TorqLOC® hollow shaft mounting system: page 141

1.7 Explosion-proof gearmotors

Explosion-proof gear units



Ex EAC

Helical gear units, RX, R, RM series	<ul style="list-style-type: none"> – For the European market: Gear units comply with Directive 2014/34/EU (ATEX), equipment group II, equipment category 2, II2GD design – Also accepted in China – Compliant with TR CU of the Eurasian Custom Union Russia/Belarus/Kazakhstan/Armenia in combination with Ex EAC certificate (successor to GOST-R)
Parallel-shaft helical gear units, F, F.M series	
Helical-bevel gear units, K, K.M series	
Helical-worm gear units, S series	
SPIROPLAN® right-angle servo gearmotors, W series	
Planetary servo gearmotors PS.F.CMP. / PS.C.CMP. series	<ul style="list-style-type: none"> – For the European market: Gear units comply with Directive 2014/34/EU (ATEX), equipment group II, equipment category 2, II2GD design – Also accepted in China – Compliant with TR CU of the Eurasian Custom Union Russia/Belarus/Kazakhstan/Armenia in combination with Ex EAC certificate (successor to GOST-R)
Helical-bevel servo gearmotors, BS.F.CMP. series	
Helical servo gearmotors, R..CMP. series	
Parallel-shaft helical servo gearmotors, F.CMP. series	
Helical-bevel servo gearmotors, K..CMP. series	
Helical-worm servo gearmotors, S..CMP. series	
SPIROPLAN® right-angle gearmotors, W..CMP. series	

1.7 Explosion-proof gearmotors

Explosion-proof motors



EDR.. series (AC motor)

- Compliant with EC Directive 2014/34/EU (ATEX) and IECEx
- For use in categories 2G, 2GD and 3GD, 3D for zones 1/21 and 2/22
 - Also available as brakemotor in category 3
 - EDRN.. motors comply with efficiency class IE3 to IEC 60034-30-1.
 - EDRE.. motors conform to the efficiency class IE2 according to IEC 60034-30-1
 - In accordance with IECEx to EPL Gb and Db as well as Gc and Dc
 - EDRS and EDRE motor types are audited and certified to IECEx “Certified Equipment Scheme” with ExTr, QAR and CoC by PTB; for detailed information on the certification system, refer to the International Electrotechnical Commission website.
 - Operation on a frequency inverter, also in field weakening operation, for categories 2 and 3 and/or EPL.b and .c
 - Safety encoder for operation on frequency inverter
 - Available with safety encoder and safety brake
 - Certified by the Korean institution KOSHA for South Korea
 - Compliant with TR CU, the Eurasian Custom Union Russia/Belarus/Kazakhstan/Armenia in combination with the Ex EAC certificate (successor to GOST-R)
 - Certified by INMETRO for Brazil
- According to HazLoc-NA® (NEC500/C22.1)
- Motors are certified to the Class Division System by CSA and thus comply with the explosion protection requirements of the North American market
 - Available as CID2 type, for division 2 class I for gas groups A, B, C and D
 - Available as CIID2 type, for division 2 class II for dust groups F and G
 - Available as type /CICIID2, for division 2 class I for gas groups A, B, C and D, and class II for dust groups F and G
 - Also available as brakemotor
 - Operation possible with frequency inverter



CMP.. series (synchronous servomotor)

- Complies with Directive 2014/34/EU (ATEX), equipment group II, equipment category 3
- Category II 3GD, suitable for use in zones 2/22
 - Category II 3D, suitable for use in zone 22
 - In category 3D also available with brake and HIPERFACE® encoder (with electronic nameplate)
 - Compliant with TR CU of the Eurasian Custom Union Russia/Belarus/Kazakhstan/Armenia in combination with Ex EAC certificate (successor to GOST-R)

Explosion-proof standard gearmotors



Gear unit		EDR... motor
Gear unit sizes	M_{amax} gear unit Nm	Power kW
Helical gearmotors RX57 – RX107 (one stage)	69 – 830	0.12 – 45
Helical gearmotors RX57 – RX107 (two and three stages)	50 – 18 000	0.12 – 200*
Parallel-shaft helical gearmotors F27 – F157 (two and three stages)	130 – 18 000	0.12 – 200*
Helical-bevel gearmotors K..19 – K..49 (two stages)	80 – 500	0.12 – 7.5
Helical-bevel gearmotors K..37 – K..187 (three stages)	200 – 50 000	0.12 – 200*
Helical-worm gearmotors S37 – S97 (two stages)	92 – 4 000	0.12 – 45
SPIROPLAN® right-angle gearmotors W20 – W47 (one and two stages)	40 – 180	0.12 – 4

* The power ratings of the explosion-proof standard gearmotors differ depending on the various applicable directives and standards ATEX, HazLoc-NA®, IECEx, KOSHA, and CSA. The maximum power is specified in the motor data e.g. at www.sew-eurodrive.com.

Explosion-proof servo gearmotors



Gear unit	With CMP. motor (high dynamics)
Gear unit sizes	Torque range M_{aDyn} Nm
Planetary servo gearmotors PS.F121 – PS.F922	15 – 4 200
Helical-bevel servo gearmotors BS.F202 – BS.F802	15 – 1 680
Helical gearmotors RX57 – RX107	6.6 – 910
Helical servo gearmotors R07 – R127	12 – 6 000
Parallel-shaft helical gearmotors F27 – F107	15 – 8 860
Helical-bevel servo gearmotors K..19 – K..49	16 – 605
Helical-bevel servo gearmotors K..37 – K..107	15 – 9 090
Helical-worm servo gearmotors S37 – S67	18 – 580
SPIROPLAN® right-angle servo gearmotors W10 – W47	12 – 215

02 GEAR UNITS

2.1 Standard gear units

Helical gear units, R series	120
Parallel-shaft helical gear units, F series	121
Helical-bevel gear units, K series	122
Helical-worm gear units, S series	124
SPIROPLAN® right-angle gear units, W series	125

2.2 **NEW:** Gear units for agitators and mixing plants

Helical gear units, RM series	126
Parallel-shaft helical gear units, FM../FAM.. series	126
Helical-bevel gear units, KM../KAM.. series	127

2.3 Servo gear units

Planetary servo gear units, PS.F / PS.C series	128
Helical-bevel servo gear units, BS.F series	130

2.4 Stainless steel gear units

Helical gear units, RES series	132
Helical-bevel gear units, KES series	132

2.5 Explosion-proof gear units

Standard gear units, R, F, K, S, W series	134
Servo gear units, PS.F, BS.F series	135

2.6 Accessories and options

Motor adapters and input shaft assemblies	136
Corrosion and surface protection	138
NEW: XCO® drive package	140
TorqLOC® hollow shaft mounting system	141
Oil aging – oil condition monitoring	142
NEW: Vibration SmartCheck – vibration analysis	144

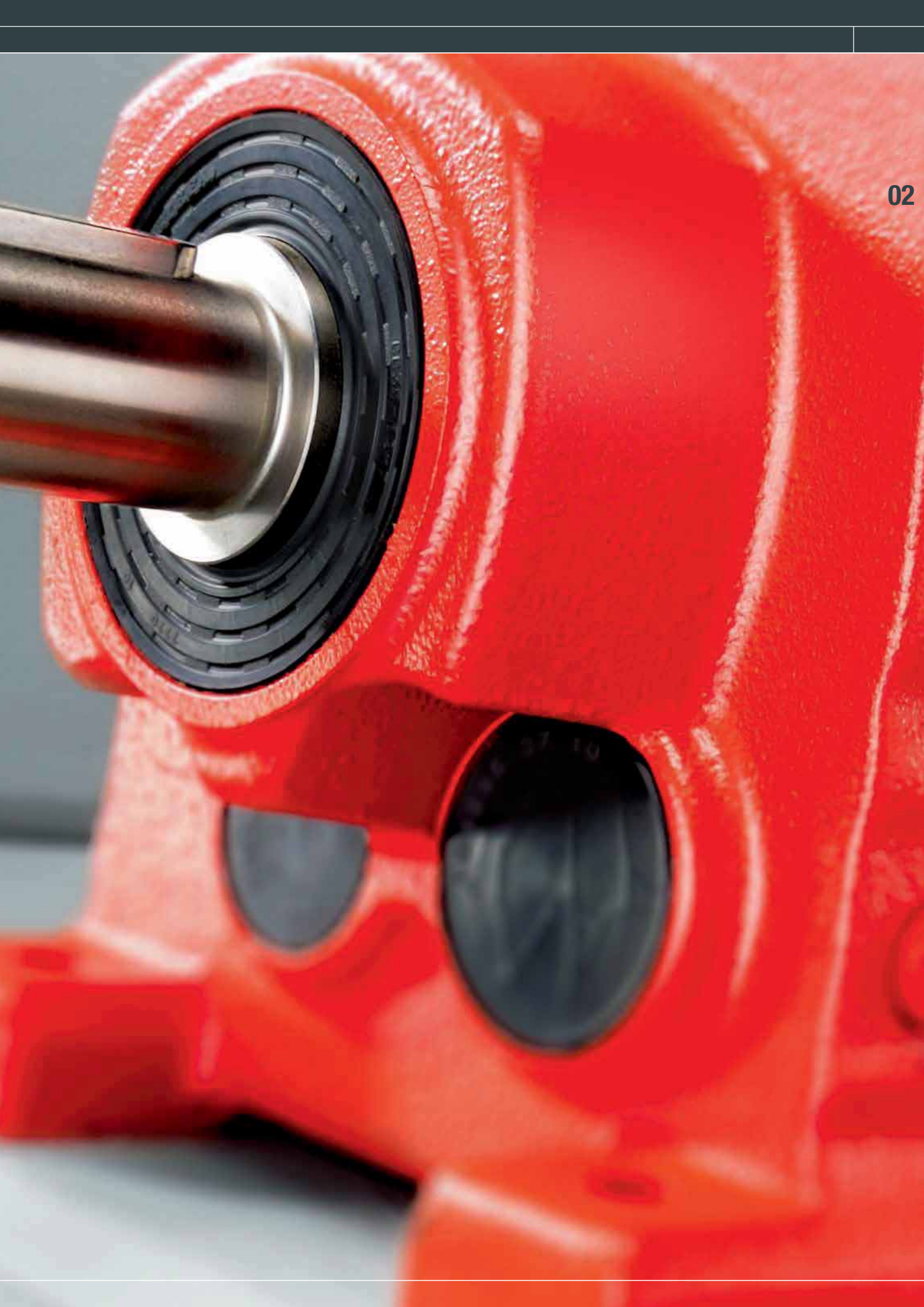

2.1 Standard gear units

Helical gear units



RX series (one stage)

6 sizes from 69 – 830 Nm

Sizes 57 / 67 / 77 / 87 / 97 / 107

Features	<ul style="list-style-type: none"> – Highly efficient helical gear units – High output speeds – Foot- or flange-mounted design 	
Gear unit ratio	i	1.30 – 8.65
Max. output torque	Nm	69 – 830
Motor power range (mounting via AM motor adapter)	kW	0.12 – 45



R series (two and three stages)

15 sizes from 50 – 20 000 Nm

Sizes 07 / 17 / 27 / 37 / 47 / 57 / 67 / 77 / 87 / 97 / 107 / 127 / 137 /
147 / 167

Features	<ul style="list-style-type: none"> – Optimum ratio between performance and space requirements – Finely stepped sizes and gear ratios – Foot- or flange-mounted design – Also available with reduced backlash 	
Gear unit ratio	i	3.21 – 289.74
Gear unit ratio – compound gear units	i	90 – 27 001
Max. output torque R07 – R167	Nm	50 – 20 000 *
Motor power range (mounting via AM motor adapter)	kW	0.12 – 90

* Also with reduced backlash

Parallel-shaft helical gear units

02



F series (two and three stages)

11 sizes from 130 – 20 000 Nm

Sizes 27 / 37 / 47 / 57 / 67 / 77 / 87 / 97 / 107 / 127 / 157

Features

- Slim design for limited installation space
- Also available with reduced backlash
- Particularly suited for materials handling and process engineering applications
- Available designs:
Foot- or flange-mounted design, B5 or B14 flange, solid or hollow shaft, hollow shaft with keyed connection, shrink disk, splining, or TorqLOC®

Gear unit ratio	i	3.77 – 281.71
Gear unit ratio – compound gear units	i	87 – 31 434
Max. output torque	Nm	130 – 20 000 *
Motor power range (mounting via AM motor adapter)	kW	0.12 – 90

* Also with reduced backlash

➔ **Motor adapters and input shaft assembly: pages 136 – 137**

2.1 Standard gear units

Helical-bevel gear units



K series (three stages)

12 sizes from 200 – 53 000 Nm

Sizes 37 / 47 / 57 / 67 / 77 / 87 / 97 / 107 / 127 / 157 / 167 / 187

Features

- Their high level of efficiency makes them energy-saving angular drives
- High-endurance gearing makes for high-torque, wear-free drives
- Long maintenance-free service life
- Also available with reduced backlash
- Available designs:
 - Foot- or flange-mounted design
 - B5 or B14 flange
 - Solid or hollow shaft
 - Hollow shaft with keyed connection, shrink disk, splining, or TorqLOC®

Gear unit ratio	i	3.98 – 197.37
Gear unit ratio – compound gear units	i	94 – 32 625
Max. output torque	Nm	200 – 53 000 *
Motor power range (mounting via AM motor adapter)	kW	0.12 – 90

* Also with reduced backlash



K series (two stages)

4 sizes from 80 – 500

Sizes K..19, K..29, K..39 and K..49

Features

- Can be used in all industries and applications, e.g. in lifts or conveyor applications
- Low loss, two-stage design (helical/hypoid gearing)
- Gearing with infinite fatigue strength, which means the drive is almost wear-free
- Can be combined with all motors from SEW-EURODRIVE
- Energy efficiency:
 - Gearing efficiency of more than 90% → low energy consumption
 - Gear unit efficiency allows for smaller motors → compact design
 - Motor energy efficiency classes from IE1 to IE4 can be implemented
- Wide range of designs ensures an optimum connection to the customer machine even in critical mounting situations

		Sizes			
		K..19	K..29	K..39	K..49
Max. output torque	Nm	80	130	300	500
Solid shaft	mm	20	25	30	35
Hollow shaft with key KA..	mm	20	25/30 (30 according to DIN 6885-3)	30/35	35/40
Flange diameter K.F.	mm	120 / 160	160 / 200	160	200
Gear unit ratio	i	4.50 – 58.68	3.19 – 71.93	2.81 – 58.24	4.00 – 75.20
Motor power range (mounting via AM motor adapter)	kW	0.12 – 1.1	0.12 – 2.2	0.12 – 4.0	0.12 – 7.5

→ Motor adapters and input shaft assembly: pages 136 – 137

2.1 Standard gear units

Helical-worm gear units



S series (two stages)

7 sizes from 92 – 4 000 Nm

Sizes 37 / 47 / 57 / 67 / 77 / 87 / 97

Features

- Significantly more efficient than plain worm gear units due to helical-worm combinations
- Very low-noise operation
- Available designs:
 - Foot- or flange-mounted design
 - B5 or B14 flange
 - Solid or hollow shaft
 - Hollow shaft with keyed connection, shrink disk or TorqLOC®

Gear unit ratio	i	3.97 – 288.00
Gear unit ratio – compound gear units	i	110 – 33 818
Max. output torque	Nm	92 – 4 000
Motor power range (mounting via AM motor adapter)	kW	0.12 – 30

SPIROPLAN® right-angle gear units

02



W series (one and two stages)

5 sizes from 25 – 180 Nm

Sizes 10 / 20 / 30 / 37 / 47

Features

- Robust right-angle gear units with SPIROPLAN® gearing, wear-free and lightweight
- Material combination of steel on steel gearing
- Particular tooth meshing ratio
- Lightweight aluminum housing
- Can be used in any mounting position as the oil fill is independent of the mounting position; no need to change the oil fill quantity
- Available designs:
 - Foot or flange-mounted design
 - B5 or B14 flange
 - Solid or hollow shaft

Gear unit ratio	i	3.20 – 75.00
Max. output torque	Nm	25 – 180
Motor power range (mounting via AM motor adapter)	kW	0.12 – 3.0

→ Accessories and options for standard gear units:

- Surface and corrosion protection: pages 138 – 140
- TorqLOC® hollow shaft mounting system: page 141
- Oil condition monitoring and vibration analysis: pages 142 – 145
- Motor adapters: pages 136 – 137

2.2 NEW: Gear units for agitators and mixing plants

Helical gear units



RM.. series (two and three stages)

10 sizes from 450 – 20 000 Nm

Sizes 57 / 67 / 77 / 87 / 97 / 107 / 127 / 137 / 147 / 167

Features	<ul style="list-style-type: none"> – Helical gear units with extended output bearing hub – Specifically designed for agitating applications – Allow for high overhung and axial loads as well as bending moments 	
Gear unit ratio	i	4.29 – 289.74
Gear unit ratio – compound gear units	I	134 – 27 001
Max. output torque	Nm	450 – 20 000
Motor power range (mounting via AM motor adapter)	kW	0.12 – 90

Parallel-shaft helical gear units



FM../FAM.. series (two and three stages)

7 sizes from 820 – 20 000 Nm

Sizes 67 / 77 / 87 / 97 / 107 / 127 / 157

Features	<ul style="list-style-type: none"> – Helical gear units with extended output bearing hub – Specifically designed for agitators and mixing plants – Allow for high overhung and axial loads as well as bending moments – Available options: <ul style="list-style-type: none"> - Double sealing - Drywell design - Relubrication device for output bearings 	
Gear unit ratio	i	3.97 – 281.71
Max. output torque	Nm	130 – 20 000 *
Motor power range (mounting via AM motor adapter)	kW	0.12 – 90

* Also with reduced backlash

Helical-bevel gear units

02



KM../KAM.. series (three stages)

7 sizes from 820 – 20 000 Nm

Sizes 67 / 77 / 87 / 97 / 107 / 127 / 157

Features

- Helical-bevel gear units with extended output bearing hub
- Specifically designed for agitators and mixing plants
- Allow for high overhung and axial loads as well as bending moments
- Available options:
 - Double sealing
 - Drywell design
 - Relubrication device for output bearings

Gear unit ratio	i	5.20 – 197.37
Max. output torque	Nm	820 – 20 000 *
Motor power range (mounting via AM motor adapter)	kW	0.12 – 90

* Also with reduced backlash

→ Accessories and options:

- **Surface and corrosion protection: pages 138 – 140**
- **Motor adapters and input shaft assemblies: pages 136 – 137**

2.3 Servo gear units

Planetary servo gear units



PS.F series

Features

- Low-backlash planetary servo gear units
- Designed for nominal torques from 25 Nm to 3 000 Nm
- Available in three output variants:
 - PSF: B5 output flange, smooth solid shaft (without key)
 - PSKF: B5 output flange, solid shaft with key
 - PSBF: B5 output, flange block shaft according to EN ISO 9409
- Life-long lubrication
- High permitted overhung loads

Type	Size one stage/two stages	Torque class Nm	Overhung load range N	Gear ratios i	Rotational clearance ' (one stage/two stages)		
					Standard	Optional	
						Reduced (../R)	Minimized (../M)
PS(K)F	121 / 122	25	1 900 – 2 000	One stage ¹⁾	8' / 10'	4' / 6'	2' / 3'
	221 / 222	55	1720 – 2680	3 ²⁾ , 4, 5, 7, 10	6' / 8'	3' / 4'	1' / 2'
	321 / 322	110	4380 – 5480				
	521 / 522	300	6150 – 9610				
	621 / 622	600	13 400 – 14 200				
	721 / 722	1 000	25 700 – 35 900	16, 20, 25, 28, 35, 40, 49, 70, 100	6' / 8'	3' / 4'	1' / 2'
	821 / 822	1 750	51 400 – 62 800				
	921 / 922	3 000	55 000 – 83 300				
PSBF	221 / 222	55	1530 – 5000	One stage	6' / 8'	3' / 4'	1' / 2'
	321 / 322	110	8580 – 25 000	5, 7, 10			
	521 / 522	300	13 900 – 40 000	Two stages			
	621 / 622	600	20 800 – 60 000				
	721 / 722	1 000	37 900 – 120 000		15 ³⁾ , 20, 25, 35,		
	821 / 822	1 750	66 100 – 180 000	49, 70, 100			

¹⁾ Other gear ratios on request

²⁾ Only for PS(K)F 121 / 521

³⁾ Only for PSBF 322 / 522



PS.C series

Features

- Planetary servo gear units
- Designed for nominal torques between 30 and 320 Nm
- Provide the basis for diverse, dynamic, and above all, **cost-optimized drive solutions**
- Compact, lightweight design
- Any mounting position
- Life-long lubrication
- Four output variants:
 - PSC = B5 output flange, solid shaft
 - PSKC = B5 output flange, solid shaft with key
 - PSCZ = B14-output flange, solid shaft
 - PSKCZ = B14 output flange, solid shaft with key

Type	Size one stage/two stages	Torque class Nm	Overhung load range N	Gear ratios i	Rotational clearance ' (one stage/two stages)
					Standard
PS(K)C PS(K)CZ	221 / 222	30	1170 – 2000	One stage	10' / 15'
	321 / 322	65	1710 – 4000	3 ¹⁾ , 5, 7, 10	
	521 / 522	160	2900 – 6750		
	621 / 622	320	5390 – 11 000	Two stages 15 ¹⁾ , 21 ¹⁾ , 25, 30 ¹⁾ , 35, 49, 50, 70, 100	

¹⁾ Not for PS(K)C, PS(K)CZ 621 / 622

2.3 Servo gear units

Helical-bevel servo gear units



BS.F series

Features

- Low-backlash helical-bevel servo gear units
- Designed for torque classes from 40 Nm to 1 220 Nm
- Five output variants:
 - BSF: Solid shaft
 - BSKF: Solid shaft with key
 - BSBF: Flange block shaft (EN ISO 9409)
 - BSHF: Hollow shaft with shrink disk
 - BSAF: Hollow shaft with key (shaft mounted gear units)
- All variants with B5 mounting flange; foot-mounting and torque arm are optional (→ can be optimally integrated into the relevant application)
- The rotational clearance remains constantly low over the entire gear unit service life

Size	Torque class Nm	Gear unit ratios i	Rotational clearance '
202	40	3 / 4 / 6 / 8 / 10 / 15 / 20 / 25	6' ¹⁾ / 3' ²⁾
302	80	3 / 4 / 6 / 8 / 10 / 15 / 20 / 25 / 30	
402	160		
502	320	3 / 4 / 6 / 8 / 10 / 12 / 15 / 20 / 25 / 30 / 35	
602	640	3 / 4 / 6 / 8 / 10 / 12 / 15 / 20 / 25 / 30 / 35 / 40	
802	1 220		

¹⁾ Standard ²⁾ Reduced

Options for servo gear units

Direct motor mounting	Positive direct motor mounting (without terminal adapter) of the CMP.. and CM.. servomotor series from SEW-EURODRIVE
Motor adapters	EPH motor adapter for PS.F and PS.C planetary servo gear units, ECH motor adapter for PS.C planetary servo gear units, and EBH motor adapter for BS.F helical-bevel servo gear units
Reduced backlash	Optionally for PS.F planetary servo gear units and BS.F helical-bevel servo gear units with significantly smaller rotational clearance
Minimized rotational clearance	Optionally for PS.F planetary servo gear units with even more reduced rotational clearance

- ➔ **Accessories and options for servo gear units:**
Surface and corrosion protection: pages 138 – 140

2.4 Stainless steel gear units

Stainless steel gear units



Features

- For use in areas subject to frequent cleaning:
 - Intralogistics
 - Hygienic applications
 - Food and beverage industry
 - Pharmaceutical industry
 - Permanently humid environments
- Low maintenance with long service life
- Efficiency-optimized gear units
- Available as KES37 helical-bevel gearmotors and RES37 helical gearmotors
- High-quality stainless steel is used
- Easy-to-clean surface thanks to special housing design
- High grade resistance to acid and alkaline
- Recesses where dirt and liquid can accumulate were eliminated as far as possible
- IEC and NEMA adapters, also made of stainless steel, allow for variable motor mounting

Type	Max. output torque Nm	Gear unit ratio i
KES37	200	3.98 – 106.38
RES37	200	3.41 – 134.83

Stainless steel gearmotors

02

Features	<ul style="list-style-type: none">– Compact, space-saving design as gearmotor for direct mounting– The entirely stainless steel design efficiently prevents all forms of corrosion– The design without fan allows for easy and reliable cleaning of the directly mounted stainless steel motors
Motor power range kW	0.37 – 0.75 (higher power ratings for adapter mounting are available on request)

➔ **Accessories and options for stainless steel gear units:**
TorqLOC® hollow shaft mounting system: page 141

2.5 Explosion-proof gear units

Standard gear units



Ex EAC

	Certified gear units	Certified protection types
Helical gear units, RX, R, RM series	<ul style="list-style-type: none"> – For the European market: Gear units comply with Directive 2014/34/EU (ATEX), equipment group II, equipment category 2, II2GD design – Also accepted in China – Compliant with TR CU of the Eurasian Custom Union Russia/Belarus/Kazakhstan/Armenia in combination with Ex EAC certificate (successor to GOST-R) 	<ul style="list-style-type: none"> – Protection type “c” (h): Protected by safe construction (design safety) EN ISO 80079-36 and -37 – Protection type “k” (h): Protected by liquid immersion, EN ISO 80079-36 and -37
Parallel-shaft helical gear units, F, F.M series		
Helical-bevel gear units, K, K.M series		
Helical-worm gear units, S series		
SPIROPLAN® right-angle servo gearmotors, W series		

The new standard DIN EN ISO 80079-36/-37 was published in 2016 and replaces the previously known 13463-1/-5/-6/-8 standards.

The basic safety requirements of the previous EN 13463 standard were adopted into the new internationally applicable DIN EN ISO 80079.

The mechanical designs as well as permitted combinations of explosion-proof gear units remain unchanged.

But the marking of explosion-proof gear units will be significantly altered with the transition to the new standard. The letter “h” certifies that the mechanical device is basically suited for use in potentially explosive atmospheres. The previous identification for devices with protection type “c” (protection by design safety) or “k” (protection by liquid immersion) is no longer used.

Category	Atmosphere	Old marking according to directives 2014/34/EU and EN 13463-1/-5/-6/-8	New marking according to directives 2014/34/EU and DIN EN ISO 80079-36/-37
Cat. 2	Gas	II 2GD c,k T4/T120°C	II 2G Ex h IIC T4 Gb
Cat. 2	Dust		II 2D Ex h IIIC T120°C Db
Cat. 3	Gas	II 3GD c,k T4/T120°C	II 3G Ex h IIC T4 Gc
Cat. 3	Dust		II 3D Ex h IIIC T120°C Dc

➔ **Technical data: pages 120 – 125**

Servo gear units

02



Ex EAC

	Certified gear units	Certified protection types
PS.F planetary servo gear units	<ul style="list-style-type: none"> For the European market: Gear units comply with Directive 2014/34/EU (ATEX), equipment group II, equipment category 2, II2GD design 	<ul style="list-style-type: none"> Protection type “c” (h): Protected by safe construction (design safety) EN ISO 80079-36 and -37
BS.F helical-bevel servo gear units	<ul style="list-style-type: none"> Also accepted in China Compliant with TR CU of the Eurasian Custom Union Russia/Belarus/Kazakhstan/Armenia in combination with Ex EAC certificate (successor to GOST-R) 	<ul style="list-style-type: none"> Protection type “k” (h): Protected by liquid immersion, EN ISO 80079-36 and -37

The new standard DIN EN ISO 80079-36/-37 was published in 2016 and replaces the previously known 13463-1/-5/-6/-8 standards.

The basic safety requirements of the previous EN 13463 standard were adopted into the new internationally applicable DIN EN ISO 80079.

The mechanical designs as well as permitted combinations of explosion-proof gear units remain unchanged.

But the marking of explosion-proof gear units will be significantly altered with the transition to the new standard. The letter “h” certifies that the mechanical device is basically suited for use in potentially explosive atmospheres. The previous identification for devices with protection type “c” (protection by design safety) or “k” (protection by liquid immersion) is no longer used.

Category	Atmosphere	Old marking according to directives 2014/34/EU and EN 13463-1/-5/-6/-8	New marking according to directives 2014/34/EU and DIN EN ISO 80079-36/-37
Cat. 2	Gas	II 2GD c,k T4/T120°C	II 2G Ex h IIC T4 Gb
Cat. 2	Dust		II 2D Ex h IIIC T120°C Db
Cat. 3	Gas	II 3GD c,k T4/T120°C	II 3G Ex h IIC T4 Gc
Cat. 3	Dust		II 3D Ex h IIIC T120°C Dc

➔ **Technical data: pages 128 – 131**

2.6 Accessories and options

AM.. adapters for standard gear units



Features

High degree of flexibility:

- AM.. motor adapters allow for mounting standard IEC and NEMA motors to nearly any standard gear unit of the RX, R, F, K, S, and W series from SEW-EURODRIVE

Reduced idling times and downtime costs:

- The coupling ensures quick and easy assembly or disassembly of the motor on the motor adapter

Adapters AQ.., ECH.. EPH... EBH..



Features

High degree of flexibility:

- Motor adapters AQ.., ECH.. EPH.. or EBH.. allow for mounting all commercially available synchronous servomotors both to the standard gear unit series and to the planetary servo and helical-bevel servo gear units from SEW-EURODRIVE.

Reduced idling times and downtime costs:

- The coupling ensures quick and easy assembly or disassembly of the motor on the motor adapter

Input shaft assemblies – one cover, many advantages

02



Features

- Compact design
- Low weight
- Optimum configuration of the bearing service life
- Available in eight sizes, according to required performance data such as torque and overhung load
- Up to five power-dependent cover sizes can be mounted per gear unit size. Each step to the next cover size means that higher power ratings can be mounted and higher reliable input overhung loads are permitted.
- Optional with motor platform, integrated backstop, and centering shoulder

2.6 Accessories and options

Corrosion protection (KS) and surface protection (OS)



for all standard motors and gear units

Features	To optimally protect motors and gear units that are subject to severe environmental influences, SEW-EURODRIVE offers possibilities to increase the resistance of highly stressed surfaces.
KS corrosion protection	Measures to increase the resistance to corrosion: <ul style="list-style-type: none"> – All retaining screws that are loosened during inspection or maintenance work are made of stainless steel – Nameplates are made of stainless steel and various motor parts are coated with a finishing varnish – The flange contact surfaces and shaft ends are treated with a temporary rust preventive – In addition, clamping straps are used for brakemotors
OS surface protection	In addition to the standard surface protection, motors and gear units are optionally available with surface protection OS1, OS2, OS3 or OS4. This makes the gearmotors well equipped for operation under various ambient conditions.

Measures for interior treatment and standard parts

Special interior surface coating

Rustproof nameplates

RS bearing for IP56

Special interior surface coating

NOCO® fluid, the contact corrosion inhibitor

Output shaft made of stainless steel

Brakes with pressure plate made of non-corrosive material

Non-corrosive retaining parts





Special interior surface coating

Rustproof breather valves

Optional coating at the output shaft end (in the area of the radial oil seal seat)

Surface protection (OS)





02

Surface protection		Ambient conditions/sample applications
Standard		<p>For machines and systems in buildings and rooms indoors with neutral atmospheres.</p> <ul style="list-style-type: none"> – C1 (negligible)* <p>Sample applications</p> <ul style="list-style-type: none"> – Machines and systems in the automobile industry – Conveyor systems in logistics areas – Conveyor belts at airports
OS1		<p>For environments prone to condensation and atmospheres with low humidity or contamination. E.g. outdoor applications under a roof or protection device.</p> <ul style="list-style-type: none"> – C2 (low)* <p>Sample applications</p> <ul style="list-style-type: none"> – Systems in saw mills – Hall gates – Agitators and mixers
OS2		<p>For environments with high humidity or moderate atmospheric contamination. E.g. applications outdoors subject to direct weathering.</p> <ul style="list-style-type: none"> – C3 (moderate)* <p>Sample applications</p> <ul style="list-style-type: none"> – Applications in amusement parks – Funiculars and chair-lifts – Applications in gravel plants – Systems in nuclear power plants
OS3		<p>For environments with high humidity and occasionally severe atmospheric and chemical contamination. Occasional acidic or caustic wet cleaning. Also for applications in coastal areas with moderate salt load.</p> <ul style="list-style-type: none"> – C4 (high)* <p>Sample applications</p> <ul style="list-style-type: none"> – Sewage treatment plants – Port cranes – Mining applications
OS4		<p>For environments with permanent humidity and severe atmospheric or chemical contamination. Regular acidic and caustic wet cleaning, also with chemical cleaning agents.</p> <ul style="list-style-type: none"> – C5-I (severe)* <p>Sample applications</p> <ul style="list-style-type: none"> – Drives in malting plants – Wet areas in the beverage industry – Conveyor belts in the food industry

* In accordance with the corrosivity categories of DIN EN ISO 12944-2

2.6 Accessories and options

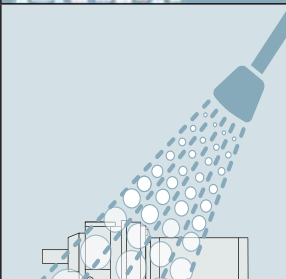
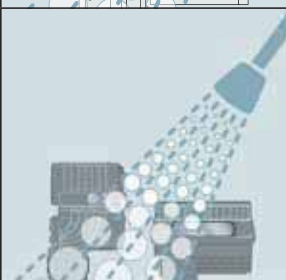
Surface protection (OS)

Surface protection		Ambient conditions/sample applications
Aseptic motors of the DAS.. series OS2–OS4 as option		Suitable for dry or wet hygienic areas with average atmospheric contamination. Also suitable for particularly dusty environments. <ul style="list-style-type: none"> – C3 (moderate)* Sample applications <ul style="list-style-type: none"> – Applications in clean rooms – Machines in the cosmetic and pharmaceutical industry – Systems for processing cereals and flour (without Ex protection) – Conveyor belts in cement plants
Aseptic motors of the DAS.. series with ASEPTIC^{plus}® drive package OS4		For hygienic areas in the food and beverage industry with permanent humidity, regular acidic and caustic wet cleaning using chemical cleaning agents, and cleaning with pressure load. <ul style="list-style-type: none"> – C5-1 (severe)* Sample applications <ul style="list-style-type: none"> – Hygienic and aseptic conveyors in the beverage industry – Systems in cheese dairies and meat processing plants – “Splash zones” in the food industry
Aseptic motors of the DAS.. series NEW with XCO® drive package		For hygienic areas in the food industry with permanent humidity and extreme acidic and caustic wet cleaning using chemical cleaning agents. XCO® surface protection prevents the risk of flaking paint. <ul style="list-style-type: none"> – C5-1 (severe)* Sample applications <ul style="list-style-type: none"> – Hygienic and aseptic applications of all types – Plants for the production of bakery products, for fruit and egg processing, meat and fish processing, and food machines for open production processes
High protection surface treatment HP200		For hygienic areas in the food and beverage industry with regular acidic and caustic wet cleaning. Anti-stick properties support the cleaning process even in inaccessible areas. Sample applications <ul style="list-style-type: none"> – Hygienic and aseptic conveyors in the beverage industry – Systems in cheese dairies and meat processing plants – “Splash zones” in the food industry
Stainless steel gearmotor		For hygienic areas in the food and beverage industry with permanent humidity and extreme acidic and caustic wet cleaning using chemical cleaning agents. Sample applications <ul style="list-style-type: none"> – Hygienic and aseptic applications of all types – Systems in cheese dairies and meat processing plants – Food processing machines for the North American market

* In accordance with the corrosivity categories of DIN EN ISO 12944-2

TorqLOC® hollow shaft mounting system

02



Cost efficient	The TorqLOC® hollow shaft mounting system is used for achieving a non-positive connection between customer shaft and hollow shaft in the gear unit, optional for parallel-shaft helical, helical-bevel or helical-worm gear units. An economic alternative to the previous hollow shaft with shrink disk, hollow shaft with key, and splined hollow shaft.
Simple	The drive can be installed and disassembled easily, even after long periods of operation. The drive is delivered with the matching bushing. The operator installs the clamping ring on the customer shaft and the drive can be mounted and fixed easily.
Economical	The TorqLOC® hollow shaft mounting system makes it possible to use drawn, unprocessed material up to quality level h11 for customer shafts, reducing costs even further. No additional machining of the customer shaft is required.
Flexible	Up to four different rated diameters can be adapted with one gear unit size, resulting in a reduction of variants.
Awards	The trade journal "Plant Engineering" awarded the "Product of the Year 2002". The award is given to innovative products which lead to ground-breaking improvements at the production level.

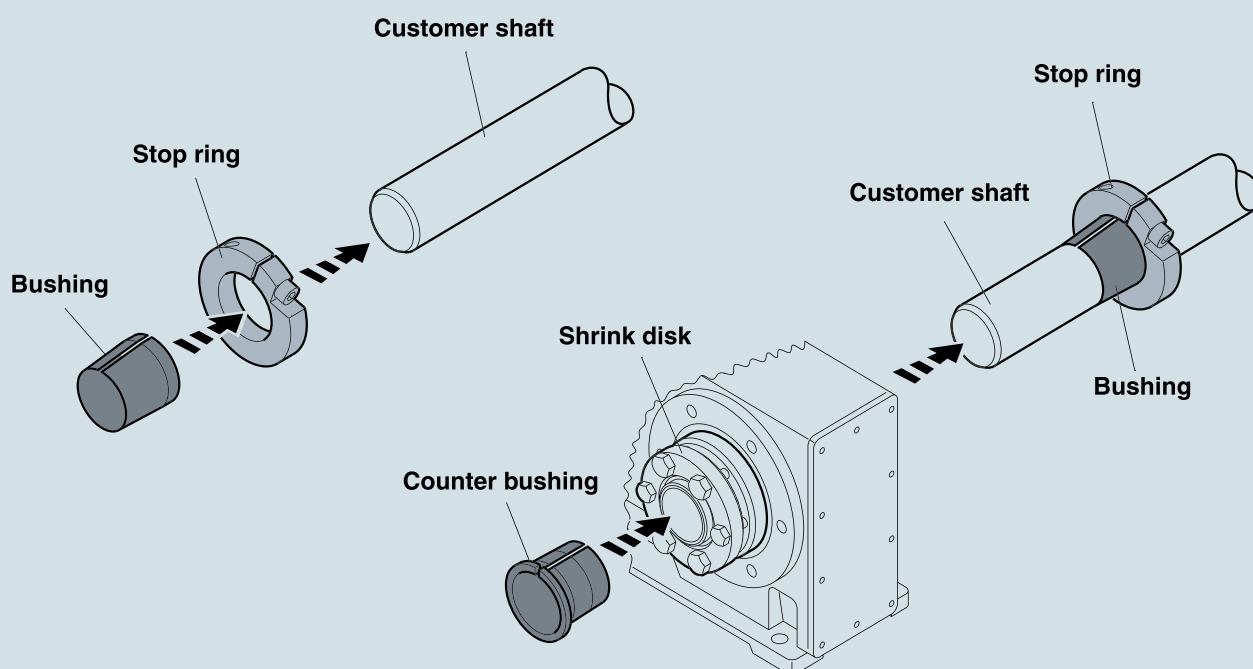

2.6 Accessories and options

Oil aging



Oil condition monitoring

Features

- The perfect sensor to determine the remaining life of the gear unit oil and reliably indicate the right time for an oil change
- A thermal sensor installed in the gear unit measures the oil temperature and sends this information to an evaluation unit, which then calculates the time remaining until the next oil change for the specified oil type
- The diagnostic unit takes the oxidation characteristics of the different oils into account under thermal stress

Advantages

- Reduction in oil costs
- Optimum utilization of the oil service life
- Startup can be performed directly on the diagnostic unit (without PC)
- Simple identification and reading of the time remaining until the next oil change
- 5 different oil types can be parameterized
- Warning message is issued if predefined limit values are exceeded, such as max. oil temperature
- Permanent oil aging monitoring
- Maintenance intervals can be planned individually

Gear unit combinations

- Helical gear units, sizes R67 – R167
- Parallel-shaft helical gear units, sizes F57 – F157
- Helical-bevel gear units, sizes K37 - K187
- Helical-worm gear units, sizes S67 – S97

For installation on small sizes or industrial gear units, contact SEW-EURODRIVE.

Technical data	Value	
Types of oil	<ul style="list-style-type: none"> – Mineral oil CLP or bio oil – $T_{max} = 100\text{ °C}$ 	
	<ul style="list-style-type: none"> – Synthetic oil CLP HC or CLP PAO – $T_{max} = 130\text{ °C}$ 	
	<ul style="list-style-type: none"> – Synthetic oil CLP PG polyglycol – $T_{max} = 130\text{ °C}$ 	
	<ul style="list-style-type: none"> – Food grade oil – $T_{max} = 100\text{ °C}$ 	
Permitted oil temperature	-40 to +130 °C	
Permitted temperature sensors	PT100 or PT1000	
EMC	<ul style="list-style-type: none"> – EN61000-4-2 ESD: 4 kV CD/8 kV AD – EN61000-4-3 HF emitted: 10 V/m – EN61000-4-4 burst: 2 kV – EN61000-4-6 HF conducted: 10 V 	
Ambient temperature	-25 to +70 °C	
Operating voltage	DC 18 – 28 V ¹⁾	
Current consumption for DC 24 V	< 90 mA (when display is active)	
Protection class	III	
Degree of protection	IP67 (optionally IP69K)	
Housing materials	Diagnostic unit	V2A; EPDM/X (Santoprene); PBT (Pocan); FPM
	Temperature sensor	V4A
Electrical connection	Diagnostic unit	M12 plug connector
	Temperature sensor	<ul style="list-style-type: none"> – PT1000: M12 plug connector – PT100: Plug connector in line with DIN 43650

¹⁾ According to EN 50178, SELV, PELV

2.6 Accessories and options

NEW: Vibration SmartCheck



Vibration analysis

Features	<ul style="list-style-type: none"> – The perfect sensor for simple and reliable monitoring of rolling bearings – The frequency spectrum is used to constantly monitor the condition of the rolling bearings – Easy startup, ready for immediate use
Advantages	<ul style="list-style-type: none"> – Fewer unplanned downtimes – Competent analysis of the measured values – Continuous monitoring of drive systems – Intuitive use – Preconfigured system for easy startup – Additional process parameters possible – Integrated web connection for real-time display of measurement data – Compact size and robust housing of the measuring system – Cost-effective solution

Technical data

Internal sensor technology

Vibration	<ul style="list-style-type: none"> – Frequency range 0.8 Hz to 10 kHz – Measuring range ± 50 g – Acceleration sensor (piezoelectric acceleration sensor)
Ambient temperature	Measuring range -20 to +70 °C

Measurement

Measurement function	<ul style="list-style-type: none"> – Acceleration – Speed and distance by integration – Temperature – Process parameters (e.g. speed, load, pressure)
Diagnostic methods	Time signal, envelope, spectrum and trend analysis, speed and frequency checking

Characteristic values (time and frequency range)

Defined characteristic values	DIN/ISO 10816
Calculated characteristic values	<ul style="list-style-type: none"> – RMS, frequency selected RMS, direct component, peak, peak to peak, crest factor, Wellhausen count, carpet level, condition monitoring – Other user-specific characteristic values are possible

Memory

Program and data	64 MB RAM, 128 MB flash
------------------	-------------------------

Technical data

Inputs and outputs

Inputs	<ul style="list-style-type: none"> – 2 analog inputs (0-10 V / 0-24 V / 0-20 mA / 3-20 mA), frequency range 0-500 Hz, 12-bit – 1 digital input (0-30 V, 0,1 Hz – 50 kHz)
Outputs	<ul style="list-style-type: none"> – 1 analog output (0-10 V / 0-20 mA / 4-20 mA), 12-bit – 1 switching output (open collector, max. 1 A, 28 V) – Optional galvanic isolation between inputs and outputs

Interfaces

Control elements	2 capacitive pushbuttons (learning mode, alarm reset, restart, factory settings)
Display elements	<ul style="list-style-type: none"> – 1 LED to display status and alarm – 1 LED to acknowledge the pushbuttons – 2 LEDs to display communication
Communication	<ul style="list-style-type: none"> – Ethernet 100 Mb/s – RS485 (currently not yet supported)
Electrical connections	3 M12 plug connectors (polarity reversal protected) for supply, RS485, inputs/outputs, and Ethernet

Other

Housing	Glass fiber reinforced plastic
Fastening	<ul style="list-style-type: none"> – Hexagon socket head screw M6 × 45 – Contact surface on the machine: 25 mm Ø
Current consumption	< 200 mA at 24 V
Operating temperature	-20 °C to +70 °C
Voltage supply	DC 11 – 32 V or power over Ethernet (PoE) based on 802.3af mode A
Size	44 mm x 57 mm x 55 mm
Weight	Approx. 210 g
Degree of protection	IP67
Operating system	Embedded Linux
Software	<ul style="list-style-type: none"> – FAG SmartWeb, FAG SmartUtility Light or optional FAG SmartUtility – Languages: German, English, Chinese, Spanish, French

03 MOTORS

3.1 AC motors

DR.. AC motors / DRN.. series	148
NEW: DRN.. < 0.75 kW and DR2S..	151
DR...J AC motors with LSPM technology	152
DRS.. pole-changing AC motors	
NEW: DR2S (2 speeds)	154
DRM.. torque motors	155
DRK.. single-phase motors	156
Excerpt of additional features	157
DAS.. aseptic motors	158
NEW: XCO® drive package	159
EDR.. explosion-proof motors	160

3.2 Servomotors

Synchronous servomotors, CMP.. series (high dynamics) and CMPZ.. (high inertia)	166
NEW: Synchronous servomotors encoderless design, CMP.. series	168
Synchronous servomotors, CM.. series (high inertia)	170
Asynchronous servomotors, DRL.. series	171
Explosion-proof motors, CMP.. series	172
Cables and connection options	174

3.3. Linear motion

SL2 synchronous linear servomotors	176
Standard CMS.. electric cylinders and modular CMSM.. electric cylinders	177

3.4 Accessories and options

Modular system for brakes:	
BE.. single brakes	184
NEW: BF../BT.. double brakes	185
Built-in encoders, low resolution	186
Built-in encoders, high resolution NEW: EI8C	187
Surface and corrosion protection	188
NEW: XCO® drive package	191
DUE diagnostic unit option (Diagnostic Unit Eddy Current)	192
NEW: Radial oil seal	
Premium Sine Seal	194

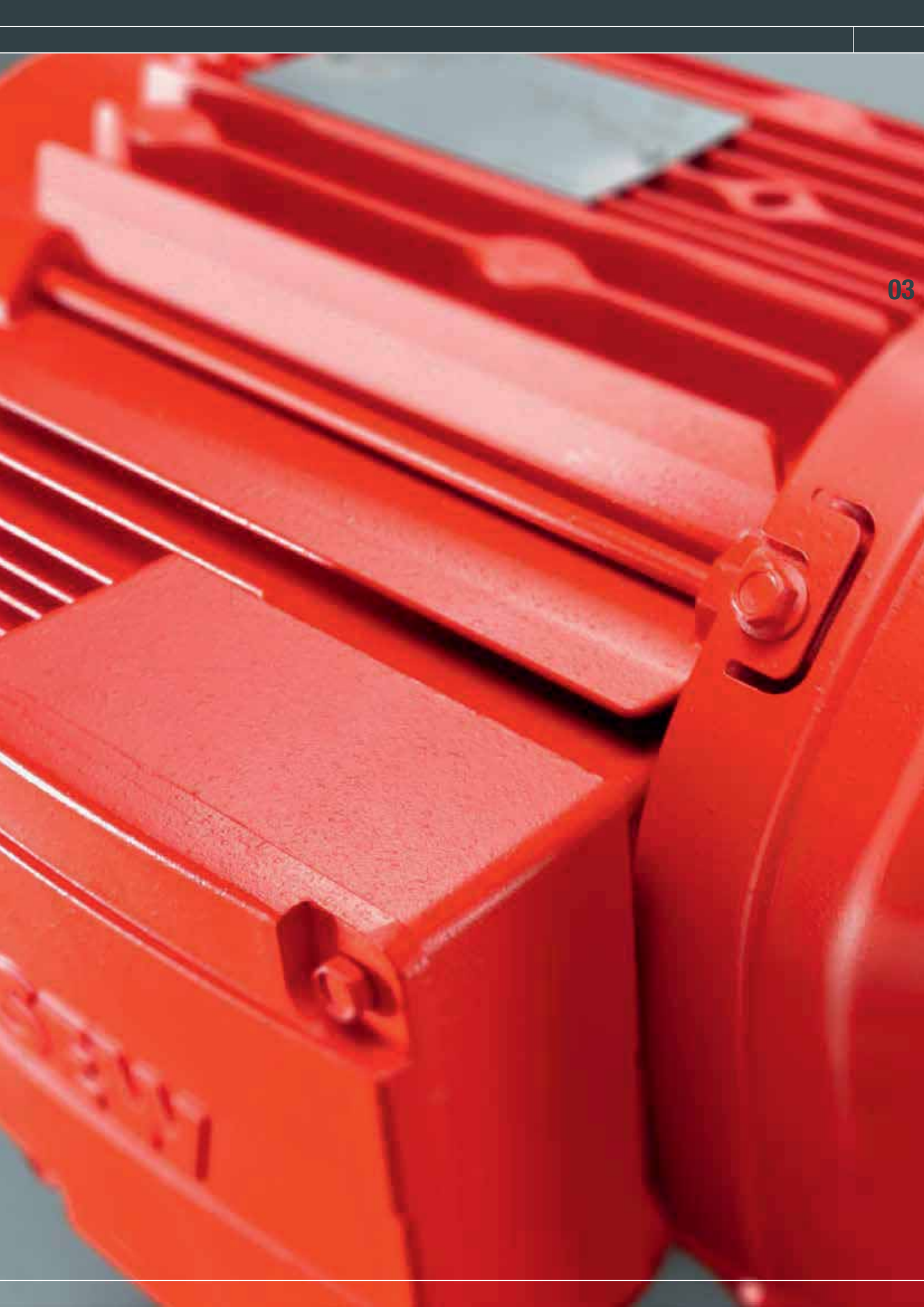

3.1 AC motors

DR.. AC motors



Standard AC motors

Well-established and safe – worldwide

<p>Features</p>	<ul style="list-style-type: none"> – Single-speed standard asynchronous motors, well established for many years in a wide variety of applications – Quality, very short delivery times and many expansion options are just three reasons for the worldwide success of these series 		
<p>Advantages</p>	<ul style="list-style-type: none"> – Direct mounting to gear units from SEW-EURODRIVE – Can be delivered with SEW-EURODRIVE single or double brakes of different sizes and braking torque steps – Built-in encoders from SEW-EURODRIVE can be integrated directly in the motors which makes the drives even more compact – As a global motor with many approvals and certifications, it can be used in many markets worldwide without the need to adapt the parts list – Comprehensive offer of options and accessories – Simple installation and startup 		
<p>Possible applications</p>	<ul style="list-style-type: none"> – Timing belts – Hoists – Pumps – Fans – Logistics facilities 		
<p>safetyDRIVE functional safety</p>  <p>Optional: integrated functional safety for DR.. motors</p>	<p>Safety encoders</p>	<p>Up to PL d according to EN ISO 13849-1</p>	<p>Incremental encoders: ES7S, EG7S, EV7S, EI7C FS NEW: EK8S Multi-turn absolute encoders: AS7W, AG7W, AS7Y NEW: AK8Y, AK8W</p>
	<p>Safety brake</p>	<p>Category 1 (cat. 1) according to EN ISO 13849-1 Category 3 (cat. 3) according to EN ISO 13849-1 Suited for integration into a safe brake system (SBS) up to performance level e (PL e).</p>	<p>BE.. BF.. / BT..</p>

Technical data	
Sizes	DR..63 – DR..315
Number of poles	2, 4, 6, 8, 4/2, 8/2, 8/4
Frequency Hz	50, 60
Rated power kW	0.09 – 225
Energy efficiency class	IE1 (DRS.., DR2S..), IE2 (DRE..), IE3 (DRN..)
Duty types	Continuous duty and intermittent duty
Suitable for inverter operation	Yes
Available as brakemotor	Yes

3.1 AC motors

DR.. AC motors



**SEW-EURODRIVE's global motor –
one solution that can be used all around the world**



Features	The global motors from SEW-EURODRIVE are the ideal solution for customers who want to serve many markets with little effort and the lowest possible quantity of part numbers. A global motor has worldwide approvals and certifications and can be used in almost any country in the world thanks to its wide voltage range.		
Advantages	<ul style="list-style-type: none"> – The motor's part number in the parts list does not depend on the country of use which means that only one design is required for the application – Required approvals and certifications can be selected according to the required countries of use – Global motors are available throughout the world which ensures short delivery times – Available in combination with the DR2S.., DRE.., DRN.., and DRL.. series 		
Countries and regions of use (excerpt)	Europe, Russia, USA, Canada, Mexico, Brazil, South Korea, Japan, Australia, New Zealand, China, India, South Africa		
safetyDRIVE functional safety  Optional: integrated functional safety for DR.. motors	Safety encoders	Up to PL d according to EN ISO 13849-1	Incremental encoders: ES7S, EG7S, EV7S, EI7C FS NEW: EK8S Multi-turn absolute encoders: AS7W, AG7W, AS7Y NEW: AK8Y, AK8W
	Safety brake	Category 1 (cat. 1) according to EN ISO 13849-1 Category 3 (cat. 3) according to EN ISO 13849-1 Suited for integration into a safe brake system (SBS) up to performance level e (PL e).	BE.. BF.. / BT..

Technical data for line operation

Sizes	DR..63 – DR..315
Number of poles	2, 4, 6
Frequency Hz	50, 60
Rated power kW	0.09 – 225
Series	DRS.., DR2S.., DRE.., DRN.., DRL..
Duty types	Continuous duty and intermittent duty
Suitable for inverter operation	Yes
Available as brakemotor	Yes

NEW: DRN.. motors < 0.75 kW and DR2S..

IE class	Number of poles	Motor type	With 50 Hz frequency	With 60 Hz and 50/60 Hz frequency	
			Power rating kW	Power rating kW	Power rating hp
IE1	2-pole	DR2S.. Sizes 63 – 80	0.18 – 1.5	0.18 – 1.5	0.25 – 2.0
	4-pole		0.12 – 1.1	0.12 – 1.1	0.16 – 1.5
	6-pole		0.09 – 0.55	0.09 – 0.55	0.12 – 0.75
IE3	2-pole	DRN..* Sizes 63 – 71	0.18 – 0.55	0.18 – 0.55	0.25 – 2.0
	4-pole	DRN.. Sizes 63 – 80	0.12 – 0.55	0.12 – 0.55	0.16 – 0.75
	6-pole	DRN..* Sizes 63 – 90	0.09 – 0.5	0.09 – 0.55	0.12 – 0.75
	8-pole	DRN..* Sizes 71 – 80	0.09 – 0.25	0.09 – 0.25	0.12 - 0.33



www.ie-guide.de/en

Energy-efficiency tools

- IE Guide
Worldwide efficiency regulation – transparent and always up-to-date
- Conversion aid
Support when changing to an energy-efficient motor
- Energy saving calculator
To determine the potential savings for energy and CO₂ as well as the payback period of the investment

Features

Using energy-efficient motors is of major importance when it comes to increasing the efficiency of automation systems. SEW-EURODRIVE provides energy-efficiency tools in the Online Support of the company website to help you answer questions about which energy efficiency class will be mandatory when and in which country, and which replacement motor is suited and profitable for your application.

Website

<https://www.sew-eurodrive.de/os/efficiency>

3.1 AC motors

DR...J AC motors with LSPM* technology

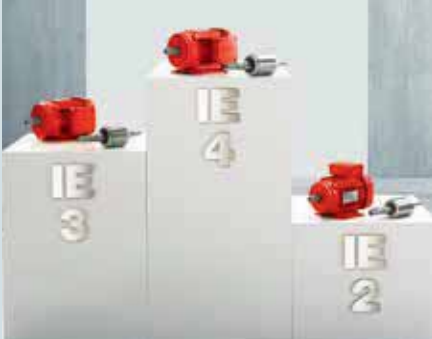

DR.. series:

DR...J design (LSPM* technology)

*** Line Start Permanent Magnet**

Features

- The **DR...J** synchronous motor design (LSPM technology) is integrated in the DR.. series modular motor system and is designed in the sizes 71S to 100L. The technology is based on adding permanent magnets below the squirrel cage of AC asynchronous motors
- **No rotor losses** occur during operation: high efficiency from IE2 to IE4
- Compared to series motors with the same power range, the same energy efficiency class is achieved with a smaller size of the DR...J motors (LSPM technology)
- Compact and robust design
- Synchronous running of the motors with operating frequency
- Slip-free speed control without encoder feedback
- DR...J-LSPM motors can be operated with the frequency inverters MOVITRAC® LTE-B and MOVITRAC® LTP-B, MOVITRAC® B, MOVIFIT® FC and MOVIMOT® D
- Can be used as individual or group drive with a frequency inverter
- Many additional features of the modular motor system are available
- Can be combined with the 7-series of the modular gear unit system from SEW-EURODRIVE
- Constant torque CT in the speed setting range without forced cooling fan

Technical data**Frequency inverter operation / 50 Hz**Constant torque from 300 – 1 500 min⁻¹ CT 1:5

Design	Energy efficiency class	Size	Power P _N kW
DRE..J	IE2	71S – 100M	0.37 – 4.0
DRP..J	IE3	71S – 100L	0.37 – 4.0
DRU..J	IE4	71S – 100L	0.18 – 3.0

Frequency inverter operation / 87 HzConstant torque from 300 – 2 610 min⁻¹ CT 1:8.7

Design	Energy efficiency class	Size	Power P _N kW
DRE..J	– *	71S – 100M	0.55 – 5.5
DRP..J	– *	71S – 100L	0.55 – 5.5
DRU..J	– *	71S – 100L	0.25 – 4.0

Line operation / 50 HzNominal speed: 1 500 min⁻¹

Design	Energy efficiency class	Size	Power P _N kW
DRE..J	IE2	71S – 100M	0.37 – 4.0
DRP..J	IE3	71S – 100L	0.37 – 4.0
DRU..J	IE4	71S – 100L	0.18 – 3.0

* IE classification as per IEC 60034-30-1:2014 is only applicable to 50 Hz or 60 Hz

3.1 AC motors

DRS.. pole-changing AC motors / **NEW:** DR2S.. (2 speeds)



Features	<ul style="list-style-type: none"> – Operated directly on the grid – Use in applications where 2 different traveling speeds are to be implemented without an inverter – Available with speed ratios of 1:2 or 1:4 and can be used globally thanks to worldwide approvals and certifications
Advantages	<ul style="list-style-type: none"> – Two traveling speeds can be achieved with just one motor during grid operation – Easy installation as no inverter is needed – Direct mounting to gear units from SEW-EURODRIVE – As a global motor with many approvals and certifications, it can be used in many markets worldwide without the need to adapt the parts list – Comprehensive offer of options and accessories – Simple installation and startup
Possible applications	<ul style="list-style-type: none"> – Systems for materials handling technology – Hoists – Cranes

Technical data

Sizes	63M – 225M
Number of poles	4/2, 8/2, 8/4
Frequency Hz	50, 60
Duty types	Continuous duty and intermittent duty
Energy efficiency class	None, exempted from energy efficiency regulations

Torque motors DRM.. / DR2M..



Short movement – safe torque off, permanently

03

Features	<ul style="list-style-type: none"> – DRM.. motors are dimensioned for operation on a 3-phase system. They are designed in such a way that they have the highest possible and continuously permitted torque at their rating point at speed 0. – Three different rated torque classes are available depending on the operating mode. This drive is preferably used in applications where the target position is reached after a very short rotation and has to be kept safely. For this reason, this motor design is also called torque motor.
Advantages	<ul style="list-style-type: none"> – DRM.. motors can be operated continuously even when the rotor is blocked – Direct mounting to gear units from SEW-EURODRIVE – Comprehensive offer of options and accessories – Simple installation and startup
Possible applications	<ul style="list-style-type: none"> – Pressing tools – Flaps – Switches – Rotary gate valves – Simple winding drives

Technical data

Sizes	71S – 132M
Number of poles	12
Frequency Hz	50, 60
Rated torque Nm	0.6 – 8.7 with continuous duty
Duty types	S1, S3/15%
Energy efficiency class	None, exempted from energy efficiency regulations

3.1 AC motors

DRK.. single-phase motors



Asynchronous motor for operation on a single-phase AC network

Features	<ul style="list-style-type: none"> – Single-phase asynchronous motors are operated on a single-phase AC network, which means no three-phase current connection is needed – Variable use as the respective connection options are available in industry, craft work and the home – The single-phase motor is operated with a running capacitor. If larger torques are required already during start-up, a start-up capacitor has to be used additionally.
Advantages	<ul style="list-style-type: none"> – The running capacitor is installed safely in the terminal box so that degrees of protection up to IP66 can be achieved – Direct mounting to gear units from SEW-EURODRIVE – Comprehensive offer of options and accessories – Simple installation and startup
Possible applications	<ul style="list-style-type: none"> – Screw conveyors – Conveyor belts – Agitators – Dosers – Pumps – Fans – Compressors

Technical data

Sizes	71S – 90L
Number of poles	4
Rated power kW	0.18 – 1.1
Frequency Hz	50, 60
Duty types	S1
Energy efficiency class	IE1
With running capacitor	ET56, DRK71S – DRK90L
Without running capacitor	ER63

Excerpt of accessories and options for the DR.. series

A comprehensive selection of accessories and options is available for motors and brakemotors, such as:

Mechanical additions	BE..	Single spring-loaded brake with size specification
	BF..	Double spring-loaded brake with size specification for industrial applications
	BT..	Double spring-loaded brake with size specification for entertainment technology applications
	HF, HR, HT	Manual brake release, lockable, automatic re-engaging function or separable
	/RS	Backstop
	/MSW	MOVI-SWITCH®, integrated switching and protection function
	/MM..	MOVIMOT®, integrated frequency inverter
Temperature sensor/detection	/TF	3 temperature sensors (positive coefficient thermistor or PTC resistor) connected in series
	/TH	3 thermostats (bimetallic switches) in series
	/PK	1 or 3 temperature sensor(s) PT1000
	/PT	1 or 3 temperature sensor(s) PT100
Ventilation	/V forced cooling fan, /Z additional flywheel mass, /AL metal fan, /U non-ventilated (without fan), /OL non-ventilated (closed B-side), /C canopy	
Bearings	/NS	Relubrication device
	/ERF	Reinforced bearing for high overhung loads (only with NS)
	/NIB	Insulated bearing (B-side)
Connection	/IS	Integrated plug connector
	/AS..	installed plug connectors of various types
	/KCC	Terminal strip with cage clamps
	/KC1	C1-compliant connection for electrified monorail systems (VDI guideline 3643)
Encoders	/E.../A... (e.g. AK8W)	Incremental and multi-turn absolute encoders, also available for functional safety and in design for potentially explosive atmospheres Mechanical interface: /.S.: Mounting via spread shaft /.V.: Mounting via coupling and solid shaft /.G.: Mounting via plug-in shaft /.H.: Mounting via hollow shaft NEW: /.K.: Mounting via cone shaft Electrical interface: /...R: TTL (RS422) /...C: HTL /...S: SinCos /...W: SinCos + RS485 /...Y: SinCos or TTL + SSI /...H: HIPERFACE®
	/EI.. (e.g. EI7C)	Incremental encoders, built-in encoder integrated without adding motor length, also for functional safety Electrical interface: /...R: TTL (RS422) /...C: HTL /EI7.: with up to 96 incr./revolution NEW: /EI8.: with HTL/TTL interface and 4096 incr./revolution
	/XV..	Mounting or mounting device of encoders that are not included in the portfolio of SEW-EURODRIVE
Condition monitoring	/DUE	Brake diagnostics with continuous function and wear monitoring
Other options (excerpt)	/DH	Condensation drain hole
	/2W	Second shaft end on the motor/brakemotor
	/RI	Reinforced winding insulation for frequency inverter operation > AC 500 V
	/RI2	Reinforced winding insulation with increased resistance against partial discharge

3.1 AC motors

Aseptic motors



DAS.. series

Features

For dry hygienic areas

DAS.. series aseptic gearmotors for drive solutions with smooth surfaces and without fans:

- IP66 degree of protection for motors (IP65 for brakemotors)
- Motor corrosion protection: KS internal coating
- Surface protection OS2 to OS4
- Motor protection thermistor in thermal class F, TH (thermo contact) optional
- IS plug connector
- From 0.25 kW with IE3

Type

Power in duty type kW

S1 = Continuous duty

S3 = Intermittent duty

		60%	40%	25%
DAS80K4	0.25 (IE2)	0.3	0.37	0.55
DAS80N4	0.25 (IE3) / 0.37 (IE2)	0.45	0.55	0.75
DAS90S4	0.37 (IE3) / 0.55 (IE3)	0.75	0.9	1.1
DAS90L4	0.75 (IE2)	0.98	1.1	1.5
DAS100M4	0.75 (IE3) / 1.1 (IE3)	1.35	1.7	2.2
DAS100L4	1.5 (IE3)	1.85	2.3	3.0

ASEPTIC^{plus}® drive package	<p>for hygienic production areas</p> <p>DAS.. aseptic motors with ASEPTIC^{plus}® drive package:</p> <ul style="list-style-type: none"> – IP69K degree of protection for motors (IP65 for brakemotors) – OS4 surface protection – Contour recesses filled with rubber – Double oil seals (if possible) at the output made of FKM (fluorocarbon rubber) – Stainless steel breather valve – Pressure compensation membrane at motor terminal box – Cable entry with screw plugs made of stainless steel – Gear unit output shaft made of stainless steel as solid shaft, hollow shaft with key or TorqLOC® for gear unit types: R17-97, F37-97, K37-97, S37-97 and W30 – All retaining parts on the output shaft, such as screws, key, shrink disk, etc., are made of stainless steel
NEW: XCO® drive package	<p>for hygienic production areas</p> <p>DAS.. aseptic motors with XCO® drive package</p> <ul style="list-style-type: none"> – IP66 or IP69k degree of protection for motors – Innovative and permanent tin-nickel surface protection – No risk of flaking paint – Stainless steel look – High corrosion resistance – Food grade approval according to 1935/2004/EC – Nameplate in stainless steel – Breather valve and all connecting bolts in stainless steel – Pressure compensation membrane on the motor terminal box – Cable entry with screw plugs made of stainless steel – For gear unit types: R.27-57, S..37-57 – Other gear unit types are currently in preparation

3.1 AC motors

Explosion-proof motors



EDR.. series

Compliant with EC Directive 2014/34/EU (ATEX) and IECEx



Features

- Compliant with the efficiency classes required in many countries according to the local energy efficiency requirements
- EDRN.. motors conform to the efficiency class IE3 according to IEC 60034-30-1
- EDRE.. motors conform to the efficiency class IE2 according to IEC 60034-30-1
- Approvals for the motor according to the latest internationally applicable directives and standards for explosion protection
 - EU Directive 2014/34/EU (ATEX)
 - IEC/EN 60079-0, gas IEC/EN 60079-7, IEC/EN 60079-15 and dust IEC/EN 60079-31
- The EC type examination certificate of category 2 motors and the conformity with quality assurance of the production process required according to the EU Directive were created by PTB
- EDR.. motors as well as SEW-EURODRIVE were audited and certified by the PTB in compliance with IECEx "Certified Equipment Scheme" with ExTr, QAR and CoC. The certificates are available at <http://iecex.iec.ch>.
- EDRS.. and EDRE.. motors comply with TR CU of the Eurasian Custom Union Russia/Belarus/Kazakhstan/Armenia in combination with Ex EAC certificate (successor to GOST-R)
- EDRS.. and EDRE.. motors are certified by the Korean institution KOSHA for South Korea
- EDRS.. and EDRE.. motors are certified by the DNV certification authority based on the IECEx certification according to the requirements of the Brazilian authority INMETRO. This also includes certification of the production sites.
- Grid operation, switching operation and inverter operation, also in field weakening range operation, allow for using the motors in almost every application
- Motors with combined gas and dust approval (design /GD) reduce the motor variance
- Motors according to ATEX and IECEx are identical regarding the most important technical properties (e.g. the same power rating for the same size)
- Many additional features of the modular motor system are available, such as brake, encoder, forced cooling fan, motor protection, etc.
- Can be combined with the standard gear units of the modular gear unit system from SEW-EURODRIVE
- Same compact and performance-oriented characteristics as the standard motors, also in combination with standard gear unit or ATEX gear unit

safetyDRIVE
functional safety



Optional: integrated functional safety for EDR.. motors

<p>NEW: Safety encoders</p>	<p>Up to PL d according to EN ISO 13849-1</p>	<p>Incremental encoders: ES7S, EG7S, EV7S NEW: EK8S Multi-turn absolute encoders: AS7W, AG7W, AS7Y NEW: AK8Y, AK8W</p>
<p>NEW: Safety brake</p>	<p>Category 1 (cat. 1) according to EN ISO 13849-1 - Suited for integration into a safe brake system (SBS) up to performance level e (PL e).</p>	<p>BE..</p>

Design ATEX	Design IECEX	Explosion protection	Zone	Type 4-pole / size	IE class	Power range kW
/3D and /3GD	/3Gc and /3GDc	II3G, Ex ec, IIB/IIC, T3, Gc	2	DR63*	–	0.12 – 0.25
		II3D, Ex tc, IIIB/IIIC, T120 °C / T140° C, Dc	22	EDRS 71 – 80 EDRE 80 – 225 EDRE 250 – 315*	IE1 IE2 IE2	0.25 – 0.55 0.75 – 45 55 – 200
/2G and /2GD	/2Gb and /2GDb	II2G, Ex eb, IIB/IIC, T3, Gb	1	EDRS 71 – 80 EDRE 80 – 225	IE1 IE2	0.25 – 0.55 0.75 – 37
		II2D, Ex tb, IIIB/IIIC, T120 °C, Db	21			
/2G and /2GD	/2Gb and /2GDb	II2G, Ex eb, IIB/IIC, T4, Gb	1	EDRS 71 – 80 EDRE 80	IE1 IE2	0.25 – 0.55 0.75
		II2D, Ex tb, IIIB/IIIC, T120 °C, Db	21			

* Only acc. to ATEX

NEW: EDRN63MS – 80MK, EDRN80M – 315H

Design ATEX	Design IECEX	Explosion protection	Zone	Type 4-pole / size	IE class	Power range kW
/3G, /3D and /3GD	/3G-c, /3D-c and /3GD-c	II3G, Ex ec, IIB/IIC, T3, Gc	2	NEW: EDRN63MS – 80 MK EDRN80 – 315	IE3	0.12 – 0.55 0.75 – 100* 0.75 – 200
		II3D, Ex tc, IIIB/IIIC, T120 °C / T140° C, Dc	22			
/2D /2G and /2GD	2D-c /2G-b, and /2GD-b	II2G, Ex eb, IIB/IIC, T1/T2/ T3, Gb	1			
		II2D, Ex tb, IIIB/IIIC, T120 °C, Db	21			
/2G and /2GD	/2G-b and /2GD-b	II2G, Ex eb, IIB/IIC, T4, Gb	1	EDRN80M		0.75
		II2D, Ex tb, IIIB/IIIC, T120 °C, Db	21			

* Motors in /2G, /2GD, 2G-b and /2GD-b design have a reduced power rating as of size 180.

3.1 AC motors

Explosion-proof motors



EDR.. series according to HazLoc-NA® (Hazardous Locations North America)



Features

- EDRN.. motors not only meet the requirements of efficiency class IE3 according to IEC 60034-30-1 but also comply with EISA 2007 and CSA C390-10 for the North American market. This means they also meet the requirements of many countries that accept these standards.
- The motors are certified according to the Class Division System and thus meet the requirements of the explosion protection regulation on the North American market and the basic standards CSA 22.2 and NEC 500
- Available as gearmotor/motor, /CID2 type, for division 2 class I for gas groups A, B, C and D
- Available as gearmotor/motor, /CIID2 type, division 2 class II for dust groups F and G
- Available as gearmotor/motor, /CICIID2 type, for division 2 class I for gas groups A, B, C and D and class II for dust groups F and G
- Also available as brakemotor with holding function
- SEW-EURODRIVE is certified to UL and CSA
- Operation on frequency inverter, also in field weakening range operation, possible in both classes
- Same compact and performance-oriented characteristics as the standard drives
- Motors also available with ATEX gear units (2014/34/EU) on request

Division 2	Type 4-pole	IE class	Power range kW
Class I Groups A, B, C, and D T3 for operation on frequency inverter T3C for operation on supply system T3B/C brakemotor on supply system	EDRS 71 – 80	IE1	0.18 – 0.55
	EDRN 80 – 315	Premium (IE3)	0.75 – 200
Class II Groups F and G T4A for operation on supply system T3 for operation on frequency inverter	NEW: EDRN63MS – 80MK	Premium (IE3)	0.12 – 0.55

Explosion-proof AC asynchronous motors in combination with frequency inverters



03

Features	<p>Overview of the advantages of this combination over AC asynchronous motors in protection type “d” (EN 60079-1; flameproof enclosure):</p> <ul style="list-style-type: none"> – High efficiency – Lighter weight – Shortest possible delivery times, high availability – Certified for operation with SEW-EURODRIVE frequency inverters – Also suitable for pump and fan drives – Delivery from a single source, from a manufacturer that offers both components itself – Higher speeds <p>Strict adherence to guidelines is particularly important in areas with potentially explosive gas/air and dust/air mixtures. Thanks to many years of experience and competency in this area, SEW-EURODRIVE ensures that the relevant guidelines are observed. Furthermore, the company's expertise is continually being expanded to include new and further developments.</p>
Certifications	<ul style="list-style-type: none"> – The 4-pole motors from SEW-EURODRIVE are also suited for operation on frequency inverters according to ATEX, IECEx and HazLoc-NA® – Category 2 and EPL .b and .c are certified by prototype testing – Motors are certified to HazLoc-NA® by CSA – In category 3 and division 2, brakemotors are also available – The suitability for operation on inverters is confirmed on the nameplate – A second nameplate provides all the information required for operation

Zone	Motor type	Protection type	MOVITRAC® B	MOVIDRIVE® B	MOVIMOT®
1	EDR../2GD	“e”, “eb” (EN 60079-7, increased safety)	✓*	✓	–
2	EDR../3GD	“na” (EN 60079-15, non-sparking), “ec” (EN 60079-7, increased safety)	✓*	✓*	–
21	EDR../2GD	“tb” (EN 60079-31, dust explosion protection)	✓*	✓	–
22	EDR../3GD	“tc” (EN 60079-31, dust explosion protection)	✓*	✓*	✓*
	EDR../3D				

* Also in field weakening range operation

3.1 AC motors

Explosion-proof motors in combination with frequency inverters



Features

The extensive product range of SEW-EURODRIVE inverters is available for designing electronically controlled drives:

- **MOVITRAC® MC07B:** Compact and economical standard inverter for the power range 0.25 – 75 kW. Three-phase line connection for AC 380 – 500 V.
- **MOVIDRIVE® MDX60/61B:** High-performance application inverter for dynamic drives in the 0.55 – 315 kW power range. Great diversity of applications due to extensive expansion options with technology and communication options. Three-phase line connection for AC 380 – 500 V.
- **MOVIMOT®** is a successful product in decentralized drive technology. It is the ingeniously simple combination of a gearmotor and a digital frequency inverter. MOVIMOT® in category 3D form a synthesis of EDR.. motors and integrated frequency inverter.

These types are designed specifically for use in areas with potentially explosive dust-air mixtures (zone 22) and are available in the power range of 0.25 to 3 kW, with or without brake, for connection voltages of 400 to 500 V.

Project planning	Project planning is the basic requirement for safe operation of explosion-proof motors. EDR.. motors meet the defined requirements for use in potentially explosive atmospheres of the Directive 2014/34/EU (ATEX), IECEx and HazLoc-NA® division 2. A device for direct temperature monitoring in combination with the defined parameters of the frequency inverter offers the best possible protection against excessive heating caused by overload.		
Technical data	EDR.. motors 230 / 400 V		
	Connection	Star	Delta
	P_{line} kW	M_{FI} Nm	M_{FI} Nm
Category 2G / 2D / EPL b / Div. 2	0.25 – 37	1.7 – 240	1.7 – 240
Category 3G / 3D / EPL c / Div. 2			
Category 3D with MOVIMOT®	0.25 – 3.0	1.7 – 20.5	1.2 – 9.9

For frequency inverter operation, there is no reduced load value in relation to the nominal line torque to ensure thermally safe operation as is often usual.

3.2 Servomotors

Synchronous servomotors



CMP.. series (high dynamics) and CMPZ.. (high inertia)

Features

- Highest dynamic properties due to low-inertia rotor design and high overload capacity of the motors
- Performance-optimized and extremely compact design thanks to the latest winding and magnet technology
- Standstill torques from 0.5 Nm to 95 Nm
- Optional CMPZ.. motor variant with increased rotor inertia for all applications with high load moments of inertia
- Direct motor mounting to gear units from our modular gear unit system
- Encoder technology: available are resolvers (/RH..), digital single-turn encoders (/E..H), and multi-turn absolute encoders (/A..H) with HIPERFACE® interface; other interfaces on request



- Europe: CE label
- USA: UR label
- Canada: CSA label
- EAC: Eurasian conformity



- CMP../CMPZ.. motors in sizes 40S to 100L are available in explosion-proof design, in compliance with the 2014/34/EU Directive (ATEX)
- Compliant with TR CU of the Eurasian Custom Union Russia/Belarus/Kazakhstan/Armenia in combination with Ex EAC certificate (successor to GOST-R)

Type	Rated speed min ⁻¹	Standstill torque M ₀ Nm	Dynamic limit torque M _{pk} Nm	Mass moment of inertia of the motor J _{mot} kgcm ²	
				CMP..	CMPZ..
CMP40S	3 000 / 4 500 / 6 000	0.5	1.9	0.10	–
CMP40M	3 000 / 4 500 / 6 000	0.8	3.8	0.15	–
CMP50S	3 000 / 4 500 / 6 000	1.3	5.2	0.42	–
CMP50M	3 000 / 4 500 / 6 000	2.4	10.3	0.67	–
CMP50L	3 000 / 4 500 / 6 000	3.3	15.4	0.92	–
CMP63S	3 000 / 4 500 / 6 000	2.9	11.1	1.15	–
CMP63M	3 000 / 4 500 / 6 000	5.3	21.4	1.92	–
CMP63L	3 000 / 4 500 / 6 000	7.1	30.4	2.69	–

Type	Rated speed min ⁻¹	Standstill torque M ₀ Nm	Dynamic limit torque M _{pk} Nm	Mass moment of inertia of the motor J _{mot} kgcm ²	
				CMP..	CMPZ..
CMP71S / CMPZ71S	2 000 / 3 000 / 4 500 / 6 000	6.4	19.2	3.1	9.32
CMP71M / CMPZ71M	2 000 / 3 000 / 4 500 / 6 000	9.4	30.8	4.1	10.37
CMP71L / CMPZ71L	2 000 / 3 000 / 4 500 / 6 000	13.1	46.9	6.1	12.47
CMP80S / CMPZ80S	2 000 / 3 000 / 4 500 / 6 000	13.4	42.1	8.8	27.18
CMP80M / CMPZ80M	2 000 / 3 000 / 4 500 / 6 000	18.7	62.6	11.9	30.3
CMP80L / CMPZ80L	2 000 / 3 000 / 4 500 / 6 000	27.5	107	18.1	36.51
CMP100S / CMPZ100S	2 000 / 3 000 / 4 500	25.5	68.3	19.59	79.76
CMP100M / CMPZ100M	2 000 / 3 000 / 4 500	31	108	26.49	86.66
CMP100L / CMPZ100L	2 000 / 3 000 / 4 500	47	178.8	40.24	100.41
CMP112S	2 000 / 3 000 / 4 500	30	88	74	–
CMP112M	2 000 / 3 000 / 4 500	45	136	103	–
CMP112L	2 000 / 3 000 / 4 500	69	225	163	–
CMP112H	2 000 / 3 000 / 4 500	83	270	193	–
CMP112E	2 000 / 3 000 / 4 500	95	320	222	–

safetyDRIVE

Functional safety

Optional: integrated functional safety for CMP../CMPZ.. motors

	Safety encoders	Up to PL d according to EN ISO 13849-1	AK0H, AK1H
	Safety brake	Category 1 (cat. 1) according to EN ISO 13849-1. Suited for integration into a safe brake system (SBS) up to performance level e (PL e).	BY

3.2 Servomotors

Synchronous servomotors in encoderless design



NEW: CMP.40-100 series

Features

- Encoderless synchronous motors for energy-efficient drive solutions in the area of materials handling technology
- Easier installation as the feedback cable is no longer needed
- Standstill torques from 0.5 Nm to 47 Nm
- Optional CMPZ.. motor variant with increased rotor inertia for all applications with high load moments of inertia
- Direct motor mounting to gear units from our modular gear unit system

CE EAC

- Europe: CE label
- USA: UR label (in preparation)
- Canada: CSA label (in preparation)
- EAC: Eurasian conformity

Type	Rated speed min ⁻¹	Standstill torque M_0 Nm	Dynamic limit torque M_{pk} Nm	Mass moment of inertia of the motor J_{mot} kgcm ²	
				CMP..	CMPZ..
CMP40S	3 000 / 4 500 / 6 000	0.5	1.9	0.10	–
CMP40M	3 000 / 4 500 / 6 000	0.8	3.8	0.15	–
CMP50S	3 000 / 4 500 / 6 000	1.3	5.2	0.42	–
CMP50M	3 000 / 4 500 / 6 000	2.4	10.3	0.67	–
CMP50L	3 000 / 4 500 / 6 000	3.3	15.4	0.92	–
CMP63S	3 000 / 4 500 / 6 000	2.9	11.1	1.15	–
CMP63M	3 000 / 4 500 / 6 000	5.3	21.4	1.92	–
CMP63L	3 000 / 4 500 / 6 000	7.1	30.4	2.69	–
CMP71S / CMPZ71S	2 000 / 3 000 / 4 500 / 6 000	6.4	19.2	3.1	9.32
CMP71M / CMPZ71M	2 000 / 3 000 / 4 500 / 6 000	9.4	30.8	4.1	10.37
CMP71L / CMPZ71L	2 000 / 3 000 / 4 500 / 6 000	13.1	46.9	6.1	12.47
CMP80S / CMPZ80S	2 000 / 3 000 / 4 500 / 6 000	13.4	42.1	8.8	27.18
CMP80M / CMPZ80M	2 000 / 3 000 / 4 500 / 6 000	18.7	62.6	11.9	30.3
CMP80L / CMPZ80L	2 000 / 3 000 / 4 500 / 6 000	27.5	107	18.1	36.51
CMP100S / CMPZ100S	2 000 / 3 000 / 4 500	25.5	68.3	19.59	79.76
CMP100M / CMPZ100M	2 000 / 3 000 / 4 500	31	108	26.49	86.66
CMP100L / CMPZ100L	2 000 / 3 000 / 4 500	47	178.8	40.24	100.41

3.2 Servomotors

Synchronous servomotors



CM.. series (high inertia)

Features

- Standstill torques from 5 Nm to 68 Nm
- Compact design with high power density thanks to an optimized magnetic circuit design
- High overload rating and low losses
- Electronic nameplate for quick and easy startup
- Optional: scalable HIPERFACE® encoder and high-performance working brake
- Encoder technology: available are resolvers (/RH..), digital single-turn encoders (/E..H), and multi-turn absolute encoders (/A..H) with HIPERFACE® interface; other interfaces on request



- Europe: CE label
- USA: UR label
- Canada: CSA label
- EAC: Eurasian conformity

Type	Rated speed min ⁻¹	Standstill torque M_0 Nm	Dynamic limit torque M_{pk} Nm	Inertia kgcm ²	
				Mass moment of inertia of the motor J_{mot} Nm	Mass moment of inertia of the brakemotor J_{bmot} Nm
CM71S	2 000 / 3 000 / 4 500 / 6 000	5	16.5	4.99	6.72
CM71M		6.5	21.5	6.4	8.13
CM71L		9.5	31.4	9.21	10.94
CM90S		11	39.6	18.2	22
CM90M		14.5	52.2	23.4	27.2
CM90L		21	75.6	33.7	37.5
CM112S	2 000 / 3 000 / 4 500	23.5	82.3	68.9	84.2
CM112M		31	108.5	88.9	104.2
CM112L		45	157.5	128.8	144.1
CM112H		68	238	188.7	204

DRL.. / DR2L.. asynchronous servomotors



Dynamic and precise with a high overload capacity

03

Features	– Suitable for use in applications with relatively high inertia ratios with high requirements on dynamics and control		
Advantages	– Reliable control in case of high overload		
Possible applications	– Direct mounting to gear units from SEW-EURODRIVE – Available with SEW-EURODRIVE single or double brakes of different sizes and braking torque steps – As a global motor with many approvals and certifications, it can be used in many markets worldwide without the need to adapt the parts list – Comprehensive offer of options and accessories – Simple installation and startup – Gantry order picking robots – Travel axes in palletizers – Winding drives and cutter drums – Lifting axes in gantries – Conveyor applications		
Sizes	71S – 225M		
Number of poles	4		
Rated speeds min⁻¹	1200, 1700, 2100, 3000		
Rated torque Nm	2.5 – 325		
Overload capacity	Up to 3.5 times the rated torque		
Control mode	CFC		
safetyDRIVE functional safety  Optional: integrated functional safety for DRL.. motors	Safety encoders	Up to PL d according to EN ISO 13849-1	Incremental encoders: ES7S, EG7S, EV7S Multi-turn absolute encoders: AS7W, AG7W, AS7Y
	Safety brake	Category 1 (cat. 1) according to EN ISO 13849-1 Suited for category 3 (cat. 3) according to EN ISO 13849-1 suited for integration into a safe brake system (SBS) up to performance level e (PL e)	BE.. BF.. / BT

3.2 Servomotors

Explosion-proof servomotors



CMP.40 – 100 series



Compliance with Directive 2014/34/EU (ATEX), equipment group II, equipment category 3

- Category II 3GD, suitable for use in zones 2/22
- Category II 3D, suitable for use in zone 22
- In category 3D also available with brake and HIPERFACE® encoder (with electronic nameplate)
- Compliant with TR CU of the Eurasian Custom Union Russia/Belarus/Kazakhstan/Armenia in combination with Ex EAC certificate (successor to GOST-R)

Protection types

Dust atmosphere: Protection type “t” indicates dust explosion protection due to housing according to EN 60079-0 and -31

Gas atmosphere: Protection type “nA” indicates

- Protection due to non-sparking according to EN 60079-0 and -15
- Design measures and requirements regarding dimensioning like for protection type “e”, but only fault-free (no error) operation is considered

Dust atmosphere: Degree of protection IP65

This means:

- Dust-tight housing according to EN 60079-31
- No dust can enter the housing due to the motor housing design
- Continuous monitoring of the surface temperature to exclude this as ignition source

Explosion-proof CMP.40 – 100 servomotors

- For the European market: compliant with Directive 2014/34/EU (ATEX)
- Compliant with TR CU of the Eurasian Custom Union Russia/Belarus/Kazakhstan/Armenia in combination with Ex EAC certificate (successor to GOST-R)

Category	Zone	Ex marking	Product characteristics	Encoder	Speed class	Brake
II3D	2	II3D Ex tc IIC T150 °C Dc X*	– Overload factor 3 × 10	HIPERFACE®	2 000 3 000	Yes
II3GD	2 and 22	II3G Ex nA IIC T3 Gc X* II3D Ex tc IIC T150 °C Dc X*	– Grounding screw – IP65	Resolver	4 500	–

Protection type tc → protection through housing

The motors are designed in such a way that only harmless quantities of dust can penetrate the unit (IP5X). Or they are designed in such a way that no dust can penetrate the unit under normal operating conditions (IP6X). These drives meet the requirements of zone 22, also for conductive dusts.

The motors are basically designed so that the outer surface does not exceed the specified surface temperature.

Protection type nA → non-sparking design

The motors are designed and dimensioned in such a way that no hot surfaces or sparks are caused in normal operation which may ignite a mixture of gas and air according to the specified temperature class.

* In conjunction with a matching temperature model in the inverter

3.2 Servomotors

Cables and connection options



CMP.. servomotor cable connections

Motor cable/brakemotor cable

Motor type	Power connector	Cable routing	Drive electronics
CMP40 – 63	Motor: SM1 (M23)	Fixed installation or cable carrier installation	MOVIDRIVE® application inverter MOVIAXIS® multi-axis servo inverter
	Brakemotor: SB1 (M23)		
CMP71 – 100 CMPZ71 – 100	Motor: SM1 (M23) SMB (M40)		
	Brakemotor: SB1 (M23) SBB (M40)		
CMP112	Motor: SM1 (M23) SMB (M40) SMC (M58)		
	Brakemotor: SB1 (M23) SBB (M40) SBC (M58)		

Encoder cable

Motor type	Encoder type	Cable routing	Drive electronics
CMP40 – 112 CMPZ71 – 100	RH1M resolver	Fixed installation or cable carrier installation	MOVIDRIVE® application inverter MOVIAXIS® multi-axis servo inverter
CMP40 – 63	HIPERFACE® AK0H, EK0H, AK1H, EK1H		
CMP71 – 112 CMPZ71 – 100	HIPERFACE® AK0H, EK1H, AK1H		

DR.. series AC motor cable connections: direct connection

Motor type	Encoder type	Encoder connection	Inverter connection
DR71 – DR132	EI7C, EI76, EI72, EI71	Conductor end sleeves	Conductor end sleeves MOVIDRIVE® application inverter
		M12 plug connector	
	ES7S, ES7R, AS7W, AS7Y	Conductor end sleeves	D-sub plug connector MOVIDRIVE® application inverter
		Connection cover	
DR160 – DR225	EG7S, EG7R, AG7W, AG7Y	Conductor end sleeves	
		Connection cover	
DR315	EH7S	M23 plug connector	
	AH7Y	Conductor end sleeves	

DR.. series AC motor cable connections: connection via intermediate sockets

Motor type	Encoder type	Encoder connection	Adapter plug
DR71 – DR132	ES7S, ES7R, AS7W	Conductor end sleeves	M23 plug connector (female)
		Connection cover	
DR160 – DR225	EG7S, EG7R, AG7W	Conductor end sleeves	
		Connection cover	

Intermediate socket

M23 plug connector (male)	Extension	M23 plug connector (female)
---------------------------	-----------	-----------------------------

Intermediate socket

Intermediate socket		Inverter connection
M23 plug connector (male)	Extension	D-sub plug connector MOVIDRIVE® application inverter

3.3 Linear motion

Synchronous linear servomotors



SL2 series

Features

- Suitable application areas: highly dynamic, flexible processing machines; material handling; pick and place applications
- No mechanical transmission elements and wear parts are required as linear motion and force are generated directly
- Optimized force-density ratio due to modern winding technology and laminated iron core
- Almost maintenance-free
- High control quality, dynamics and precision
- Available in three designs (SL2 Basic, SL2 Advanced System, SL2 Power System)
- Secondaries are available in various lengths and can easily be lined up

Product versions

Product versions	Rated power range N	Rated speed classes m/s
SL2 Basic	125 – 6 000	1 / 3 / 6
SL2 Advanced System	280 – 3 600	
SL2 Power System	400 – 5 500	

Options for linear servomotors

SL2 Advanced System and SL2 Power System

- The cables of the motor end have matching plug connectors
- EMC-compliant connector housing design
- Plug connectors seal the plug on the cable end with a lamellar seal and ensure strain relief in accordance with EN 61884
- Various accessories for inverter-specific prefabrication

Standard CMS.. electric cylinders / with grease lubrication



CMS71 series (with grease lubrication)

03

Features

- Equipped with permanent magnet rotors
- Precise, powerful and fast
- Combined with drive electronics from SEW-EURODRIVE, this series makes for energy-efficient drive solutions that ensure a high level of process reliability and that can be easily integrated into existing automation systems

Electrical data

Type	CMS71L		
Max. torque Nm	31.4	22.1 ¹⁾	24.4 ¹⁾
Standstill torque Nm	9.5		

Mechanical data

Rated speed n_N	2 000 min ⁻¹ 3 000 min ⁻¹ 4 500 min ⁻¹			
Spindle type	KGT ²⁾ 32x10	KGT ²⁾ 32x6	PGT ³⁾ 24x5	
Max. continuous feed force ⁴⁾ N	3 600	6 700	7 200	
Peak feed force N	17 000	20 000	15 000 20 000 ⁵⁾	20 000
Stroke lengths mm	200	200	350	200
Max. speed mm/s	500	300	200	250

¹⁾ Maximum permitted torque

²⁾ Ball screw

³⁾ Planetary roller screw

⁴⁾ Depending on average travel speed

⁵⁾ In case of tensile load

3.3 Linear motion

Standard CMS.. electric cylinders / with oil bath lubrication



CMSB50/63/71 series (with oil bath lubrication)

Features

- Patented maintenance-free oil bath lubrication (lifetime lubrication)
- Very high thermal power density
- Very low-noise operation
- Very small working strokes possible (< 1 mm)
- Combined with drive electronics from SEW-EURODRIVE, this series makes for energy-efficient drive solutions that ensure a high level of process reliability and that can be easily integrated into existing automation systems

Electrical data

Type	NEW: CMSB50S	NEW: CMSB50M	NEW: CMSB50L
Max. torque Nm	5.2	7.6 ¹⁾	7.6 ¹⁾
Standstill torque Nm	1.3	2.4	3.3

Mechanical data

Rated speed n_N	3 000 min ⁻¹ 4 500 min ⁻¹ 6 000 min ⁻¹		
Spindle type	KGT ²⁾ 20x5	KGT ²⁾ 20x5	KGT ²⁾ 20x5
Max. continuous feed force ⁴⁾ N	1 200	2 300	3 200
Peak feed force N	5 300	8 000	8 000
Stroke lengths mm	70 / 100 / 150 / 200 / 300 / 400 / 600		
Max. speed mm/s	375	375	375

Electrical data

Type	CMSB63S	CMSB63M
Max. torque Nm	11.1	11.1 ¹⁾
Standstill torque Nm	2.9	5.3

Mechanical data

Rated speed n_N	3 000 min ⁻¹ 4 500 min ⁻¹ 6 000 min ⁻¹			
Spindle type	KGT ²⁾ 25x6	PGT ³⁾ 20x5	KGT ²⁾ 25x6	PGT ³⁾ 20x5
Max. continuous feed force ⁴⁾ N	2 400	2 800	4 100	5 200
Peak feed force N	10 000		10 000	
Stroke lengths mm	60 / 100 / 160 / 180 / 200 / 400 / 600	100 / 200	60 / 100 / 160 / 180 / 200 / 400 / 600	100 / 200
Max. speed mm/s	450	375	450	375

Electrical data

Type	CMSB71S	CMSB71M	CMSB71L
Max. torque Nm	19.2	25 ⁴⁾	25 ⁴⁾
Standstill torque Nm	6.4	9.4	13.1

Mechanical data

Rated speed n_N	2 000 min ⁻¹ 3 000 min ⁻¹ 4 500 min ⁻¹ 6 000 min ⁻¹		
Spindle type	KGT ²⁾ 32x6	KGT ²⁾ 32x6	KGT ²⁾ 32x6
Max. continuous feed force ⁴⁾ N	6 200	8 200	12 000
Peak feed force N	18 000	24 000	24 000
Stroke lengths mm	100 / 160 / 200 / 400 / 600 / 800 / 1 000 / 1 200		
Max. speed mm/s	450	450	450

¹⁾ Maximum permitted torque²⁾ Ball screw³⁾ Planetary roller screw⁴⁾ Depending on average travel speed

3.3 Linear motion

Modular CMSM.. electric cylinders



CMSMB50 – 71 series / ACH or ACA (axially serial)

Features	<ul style="list-style-type: none"> – Separately available modular unit (linear gear unit) with the proven oil bath lubrication of the CMSB.. standard electric cylinder series – Can be combined with the standard servomotors from SEW-EURODRIVE (CMP50/63/71) using ACH/ACA adapters 		
safetyDRIVE functional safety  Optional: integrated functional safety for CMSMB.. motors	Safety encoders	up to PL d according to EN ISO 13849-1	AK0H AK1H
Technical data			
Type	NEW: CMSMB50 / ACH or ACA	CMSMB63 / ACH or ACA	CMSMB71 / ACH or ACA
Max. permitted input torque Nm	7	11.1	25
Max. permitted input speed min⁻¹	4 500	4 500	4 500
Peak feed force N	8 000	10 000	24 000
Stroke lengths mm	70 / 100 / 150 / 200 / 300 / 400 / 600	60 / 100 / 160 / 180 / 200 / 400 / 600	100 / 160 / 200 / 400 / 600 / 800 / 1 000 / 1 200
Spindle type	KGT ¹⁾ 20x5	KGT ¹⁾ 25x6	KGT ¹⁾ 32x6

¹⁾ Ball screw



CMSMB50 – 71 series / AP (axially parallel)

Features

- Compact design
- Patented maintenance-free oil bath lubrication (lifetime lubrication)
- Very high thermal power density
- Very low-noise operation
- Optional water cooling
- Use of CMP50/63/71 standard servomotors

safetyDRIVE
functional safety



Optional: integrated functional safety
for CMSMB.. motors

Safety encoders

up to PL d according to EN ISO
13849-1

AK0H
AK1H

Electrical data

Type

NEW: CMSMB50/AP and

CMP50S

CMP50M

CMP50L

Max. torque
Nm

5.2

7.6 ¹⁾

7.6 ¹⁾

Standstill torque
Nm

1.2

2.3

2.6

Mechanical data

Rated speed

n_n

3 000 min⁻¹

4 500 min⁻¹

6 000 min⁻¹

Spindle type

KGT ²⁾ 20x5

Max. continuous feed force
N

1 100

2 100

2 700

Peak feed force
N

5 300

8 000

8 000

Stroke lengths
mm

70 / 100 / 150 / 200 / 300 / 400 / 600

Max. speed
mm/s

375

375

375

¹⁾ Max. permitted torque

²⁾ Ball screw

3.3 Linear motion

Modular CMSM.. electric cylinders



CMSMB50 – 71 series / AP (axially parallel)

Electrical data

Type	CMSMB63/AP and		
	CMP63S	CMP63M	CMP63L
Max. torque Nm	11.1	11.1 ¹⁾	11.1 ¹⁾
Standstill torque Nm	2.9	5.3	7.1

Mechanical data

Rated speed n_N	3 000 min ⁻¹ 4 500 min ⁻¹ 6 000 min ⁻¹		
Spindle type	KGT 2 ²⁾ 25x6		
Max. continuous feed force N	2 100	3 500	5 000
Peak feed force N	10 000	10 000	10 000
Stroke lengths mm	60 / 100 / 160 / 180 / 200 / 400 / 600		
Max. speed mm/s	450	450	450

¹⁾ Max. permitted torque

²⁾ Ball screw

Electrical data

Type	CMSMB70/AP and		
	CMP71S	CMP71M	CMP71L
Max. torque Nm	19.2	25 ¹⁾	25 ¹⁾
Standstill torque Nm	6.4	9.4	13.1

Mechanical data

Rated speed n_N	2 000 min ⁻¹ 3 000 min ⁻¹ 4 500 min ⁻¹ 6 000 min ⁻¹		
Spindle type	KGT ²⁾ 32x6		
Max. continuous feed force N	5 000	7 500	10 500
Peak feed force N	18 000	24 000	24 000
Stroke lengths mm	100 / 160 / 200 / 400 / 600 / 800 / 1 000 / 1 200		
Max. speed mm/s	450	450	450

¹⁾ Max. permitted torque²⁾ Ball screw

3.4 Accessories and options

Modular brake concept

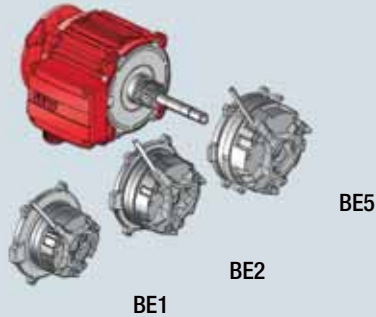

BE.. single brake

Robust, compact, proven

Features

SEW-EURODRIVE has been developing and producing spring-loaded brakes for their own motor series for decades. These brakes have proven successful in the most various applications under the most difficult situations.

Up to 3 different brake sizes per power rating are available for directly mounting BE.. single brakes to DR.. motors. This means the drive can be ideally matched to meet the requirements of the application. This modularity allows SEW-EURODRIVE to reduce inertia, extra length, and costs of the drive to a minimum.

Numerous designs and options are additionally available to adapt the brakes optimally to the operating conditions in the machine.

Advantages

High cycle times with low wear:

- BE.. single brakes have extremely short response times for application and release which makes them ideal for achieving high cycle times with low motor heating and reduced wear
- BE.. single brakes have an extremely high working capacity and can be used both as
 - holding brake with emergency switching off properties
 - and as working brake with high permitted brake application speed

High degree of protection

- AC motors from SEW-EURODRIVE with BE.. single brakes can be designed up to IP66 degree of protection.

Simple maintenance and short idle times

- BE.. single brakes are easy to maintain, long idle times are avoided
- BE.. single brakes can be adjusted, which means the brake lining carriers have a long service life with consequently low service costs involved

Short delivery times

- BE.. single brakes are an essential part of the portfolio of SEW-EURODRIVE and are held on stock worldwide for assembly and service orders. This means the short delivery times for which SEW-EURODRIVE is renowned all over the world also apply to brakemotors.

Technical data

- Direct mounting to DR.. and DRN.. motors as well as to explosion-proof EDR.. and EDRN.. motors
- Brake sizes BE02 to BE122
- Brake torque range: between 0.8 and 2400 Nm
- Numerous braking torque steps can be achieved per brake size

Options and designs

- Can be expanded by re-engaging (HR) or lockable (HF) manual brake release
- Can be optionally combined with /DUE diagnostic unit for monitoring proper functioning and wear
- Suitable for the global motors of SEW-EURODRIVE
- Safety brake: Category 1 (cat. 1) according to EN ISO 13849-1
- Suited for integration into a safe brake system (SB) up to performance level e (PL e)

safetyDRIVE
functional safety





BF../BT.. double brake for DR.. motors

The brake of your choice – brake combination options

Motor type	Brake type	W_{insp} 10 ⁶ J	Braking torque steps Nm									
			2x20	2x28	2x40	2x55	2x80	2x110				
DR.112/132	BF11	2x285										
	BT11	2x190										
DR.160	BF20	2x445			2x40	2x55	2x80	2x110	2x150	2x200		
	BT20	2x300										
DR.180	BF30	2x670					2x75	2x100	2x150	2x200	2x300	
	BT30	2x450										

Brake combination options

The DR.. motor can be combined with the BF../BT.. brake that is ideal for your application to match its requirements for the braking torque or braking work.

For design reasons, the motors with double brake from SEW-EURODRIVE are very compact.

The double brake can be used in dusty environments with or without "functional safety". An extremely low-noise BT.. design with functional safety is available to meet the requirements of entertainment technology (DIN 56950-1).

NEW: The BF../BT.. double brake can be equipped with the contactless DUE.. function and wear monitoring.

It constantly shows

- the current switching state or if the wear limit is reached and
- it transmits the current air gap.

safetyDRIVE
functional safety



Safety brake: Category 3 (cat. 3) according to EN ISO 13849-1.

- Suited for integration into a safe brake system (SBS) up to performance level e (PL e)
- Static and dynamic brake diagnostics for SEW-EURODRIVE control technology (MOVI-PLC®/CCU) in addition to the brake

3.4 Accessories and options

Built-in encoders, low resolution



Advantages		<p>The built-in encoders with low resolution available for the DR.. motor series that can be installed on the B-side between endshield and fan wheel are unique. With this solution the user does not have to provide for additional space as it is the case with add-on speed sensors*.</p> <p>The MOVITRAC® B standard inverter from SEW-EURODRIVE in combination with the “simple positioning” application module can replace applications that, up to now, have been implemented with creep/rapid speed switch-over with initiator evaluation.</p>
Built-in encoders		EI7C, EI76, EI72, EI71, EI7C FS, HTL (push pull)
Supply voltage		DC 9 – 30 V
Periods per revolution	A, B	EI7C: 24 EI7C FS: 24 EI76: 6 EI72: 2 EI71: 1
Motors		<ul style="list-style-type: none"> – DRS., DRE., DRL., DRK., DRM.. 71 – 132 – DRN., DR2S., DR2L., DR2M.. 63 – 132S – DRU.: 71 – 100
Connection technology		<ul style="list-style-type: none"> – Terminal strip in the terminal box – 8-pin M12 plug connector (including temperature sensor) – 4-pin M12 plug connector
safetyDRIVE functional safety 		EI7C FS: safety encoders up to PL d according to EN ISO 13849-1

Built-in encoders, high resolution



03

Advantage	<ul style="list-style-type: none"> – Built-in encoders with high resolution offer an adequate encoder signal with 4096 increments per revolution, which means they are equivalent to add-on encoders. Just like built-in encoders with low resolution, the encoder is installed on the B-side between endshield and fan wheel. The built-in encoder does not add extra length to the motor. This means the encoder motor is a unique compact unit. – All functions that have so far been solved using mount-on encoders, can now be implemented with the high-resolution built-in encoder in a compact manner and with improved connection technology. – High-resolution built-in encoders are set up without own bearing and without moving parts. This makes them particularly robust and absolutely wear-free. – Integration into the motor allows for subsequent installation without further measures on the motor.
Built-in encoders	<ul style="list-style-type: none"> – NEW: EI8C, HTL (push-pull) – EI8R, TTL (push-pull)
Periods per revolution	<ul style="list-style-type: none"> – A, B: 1024 – C (index): 1
Line voltage	DC 7 – 30 V
Motors	<ul style="list-style-type: none"> – DRN., DR2S., DR2L.. 71 – 132S
Connection technology	<ul style="list-style-type: none"> – Terminal strip in the terminal box – M23 plug connector on the terminal box, either with or without motor temperature sensor

3.4 Accessories and options



Corrosion protection (KS) and surface protection (OS) for all standard motors and gear units

Features	To optimally protect motors and gear units that are subject to severe environmental influences, SEW-EURODRIVE offers possibilities to increase the resistance of highly stressed surfaces.
KS corrosion protection	<p>Measures to increase the resistance to corrosion:</p> <ul style="list-style-type: none"> – All retaining screws that are loosened during inspection or maintenance work are made of stainless steel – Nameplates are made of stainless steel and various motor parts are coated with a finishing varnish – The flange contact surfaces and shaft ends are treated with a temporary rust preventive – In addition, clamping straps are used for brakemotors
OS surface protection	In addition to the standard surface protection, motors and gear units are optionally available with surface protection OS1, OS2, OS3 or OS4. This makes the gearmotors well equipped for operation under various ambient conditions.

Measures for interior treatment and standard parts

Special interior surface coating

Rustproof nameplates

RS bearing for IP56

Special interior surface coating

NOCO® fluid, the contact corrosion inhibitor

Output shaft made of stainless steel

Brakes with pressure plate made of non-corrosive material

Non-corrosive retaining parts



Special interior surface coating



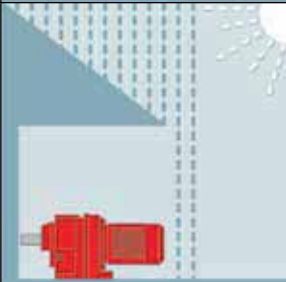
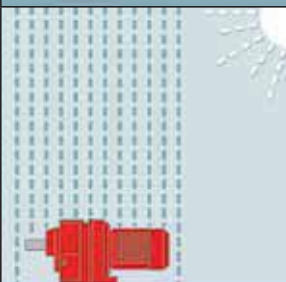
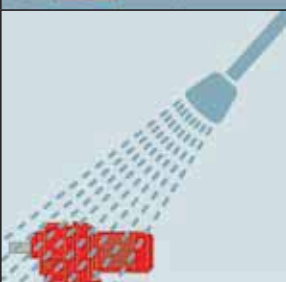

Rustproof breather valves

Optional coating at the output shaft end (in the area of the radial oil seal seat)

3.4 Accessories and options

Surface protection (OS)

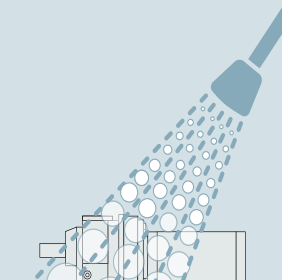
Surface protection		Ambient conditions/sample applications
Standard		For machines and systems in buildings and rooms indoors with neutral atmospheres. – C1 (negligible)* Sample applications – Machines and systems in the automobile industry – Conveyor systems in logistics areas – Conveyor belts at airports
OS1		For environments prone to condensation and atmospheres with low humidity or contamination. E.g. outdoor applications under a roof or protection device. – C2 (low)* Sample applications – Systems in saw mills – Hall gates – Agitators and mixers
OS2		For environments with high humidity or moderate atmospheric contamination. E.g. applications outdoors subject to direct weathering. – C3 (moderate)* Sample applications – Applications in amusement parks – Funiculars and chair-lifts – Applications in gravel plants – Systems in nuclear power plants
OS3		For environments with high humidity and occasionally severe atmospheric and chemical contamination. Occasional acidic or caustic wet cleaning. Also for applications in coastal areas with moderate salt load. – C4 (high)* Sample applications – Sewage treatment plants – Port cranes – Mining applications
OS4		For environments with permanent humidity and severe atmospheric or chemical contamination. Regular acidic and caustic wet cleaning, also with chemical cleaning agents. – C5-1 (severe)* Sample applications – Drives in malting plants – Wet areas in the beverage industry – Conveyor belts in the food industry

Surface protection		Ambient conditions/sample applications
Aseptic motors of the DAS.. series OS2–OS4 as option		Suitable for dry or wet hygienic areas with average atmospheric contamination. Also suitable for particularly dusty environments. <ul style="list-style-type: none"> – C3 (moderate)* Sample applications <ul style="list-style-type: none"> – Applications in clean rooms – Machines in the cosmetic and pharmaceutical industry – Systems for processing cereals and flour (without Ex protection) – Conveyor belts in cement plants
Aseptic motors of the DAS.. series with ASEPTIC^{plus}® drive package OS4		For hygienic areas in the food and beverage industry with permanent humidity, regular acidic and caustic wet cleaning using chemical cleaning agents, and cleaning with pressure load. <ul style="list-style-type: none"> – C5-I (severe)* Sample applications <ul style="list-style-type: none"> – Hygienic and aseptic conveyors in the beverage industry – Systems in cheese dairies and meat processing plants – “Splash zones” in the food industry
Aseptic motors of the DAS series NEW: with XCO® drive package		For hygienic areas in the food industry with permanent humidity and extreme acidic and caustic wet cleaning using chemical cleaning agents. XCO® surface protection prevents the risk of flaking paint. <ul style="list-style-type: none"> – C5-I (severe)* Sample applications <ul style="list-style-type: none"> – Hygienic and aseptic applications of all types – Plants for the production of bakery products, for fruit and egg processing, meat and fish processing, and food machines for open production processes
High protection surface treatment HP200		For hygienic areas in the food and beverage industry with regular acidic and caustic wet cleaning. Anti-stick properties support the cleaning process even in inaccessible areas. Sample applications <ul style="list-style-type: none"> – Hygienic and aseptic conveyors in the beverage industry – Systems in cheese dairies and meat processing plants – “Splash zones” in the food industry
Stainless steel gearmotor		For hygienic areas in the food and beverage industry with permanent humidity and extreme acidic and caustic wet cleaning using chemical cleaning agents. Sample applications <ul style="list-style-type: none"> – Hygienic and aseptic applications of all types – Systems in cheese dairies and meat processing plants – Food processing machines for the North American market

* In accordance with the corrosivity categories of DIN EN ISO 12944-2

3.4 Accessories and options

Diagnostic unit option /DUE



Diagnostic Unit Eddy Current for continuously monitoring brake function and wear

Features and advantages

- Continuous monitoring of the proper functioning of the brake as well as of the current wear condition
- Entirely wear-free method for the components
- The system has already been calibrated at the plant and is immediately ready for operation
- Available for BE., BF. and BT. brakes,
- Sizes 1 to 122
- Direct integration of the diagnostic unit in the brake without changing the geometrical dimensions of the drive
- No effect on the degree of protection of the motor

Measuring method, function and evaluation

- Contactless measuring method, which means the components of the diagnostic unit are not subject to wear
- The option /DUE diagnostic unit consists of a sensor that is inserted in the magnet body of the brake, and of an evaluation unit that is attached in the terminal box
- The signals output by the evaluation unit can be evaluated and interpreted by a higher-level controller

Technical data

Evaluation unit		DUE-1K-00 for BE.. brake	DUE-2K-00 for BF../BT.. brake
Signal outputs (2 channels)		BE.. brake Out1: 4 – 20 mA FCT1: DC 24 V (150 mA) WEAR1: DC 24 V (150 mA)	Partial brake 1 for BF../BT.. brake Out1: 4 – 20 mA FCT1: DC 24 V (150 mA) WEAR1: DC 24 V (150 mA) Partial brake 2 for BF../BT.. brake Out2: 4 – 20 mA FCT2: DC 24 V (150 mA) WEAR2: DC 24 V (150 mA)
Current consumption	Max. mA	340	360
	Min. mA	40	80
Supply voltage		DC 24 V (\pm 15%)	
Electromagnetic compatibility		DIN EN 61800-3	
Operating temperature range of the evaluation unit		-40 to +105 °C	
Humidity		\leq 90% relative humidity	
Degree of protection		IP20 (in the closed terminal box max. IP66)	
Sensors		DUE-d6-00	DUE-d8-00
Degree of protection		IP66	
Operating temperature range of sensor and cable		-50 to +150 °C	

3.4 Accessories and options

NEW: Premium Sine Seal oil seal



**The shaft for twice the service life –
new sealing system for gearmotors**

Features

- Protects the motor against oil (input side)
- Protects the gear unit interior (no leaks)
- Generates less heat at the sealing lip
- Expected service life of about 20 000 h
- No grease required

Operating principle

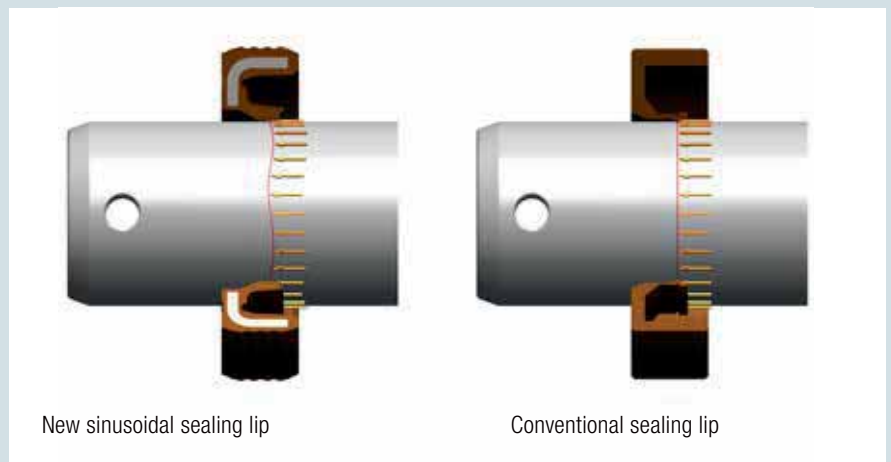

Premium Sine Seal:

- Joint development of SEW-EURODRIVE and Freudenberg Sealing Technologies of a new radial oil seal for the input motor shaft of gearmotors
- The sinusoidal shape supports the transfer of lubricant at the sealing surface
- The advantage of the new Premium Sine Seal is that its sinusoidal sealing lip exhibits substantially increased durability so that elastomer wear is reduced significantly; the elastomer is subject to less thermal strain
- Result: more than twice the service life of conventional oil seals

Advantages	<ul style="list-style-type: none"> – Reduced wear on the sealing lip by about 50% – Expected service life longer by a factor of 2 (compared to other systems on the market), which means longer maintenance intervals – No run-in or wear on the shaft – the oil seal can be replaced at the same location – Increased safety against leakage and higher system availability
Available for	<p>The new Premium Sine Seal oil seals are optionally available for CMP. synchronous servomotors (in the 3rd quarter of 2019 for asynchronous servomotors with AC motors of the DR.. series)</p> <p>In combination with:</p> <ul style="list-style-type: none"> – R series helical gear units – F series parallel-shaft helical gear units – K series helical-bevel gear units – S series helical-worm gear units – PS.F series planetary servo gear units – BS.F series helical-bevel servo gear units <p>Also optionally available for the mechatronic drive system MOVIGEAR®</p>
Areas of application	<p>Applications with dynamic speeds, alternating directions of rotation, and variable load situations, such as:</p> <ul style="list-style-type: none"> – Packaging – Food and beverage industry – Wood processing – Baggage handling (airports) – Automotive production – Transport and logistics – Handling and robotics – Processing – and much more

04

INDUSTRIAL GEAR UNITS

4.1 Helical gear units/bevel-helical gear units

Helical gear units / bevel-helical gear units, X series	198
Bevel-helical gear units, X series – conveyor drives	199
Bevel-helical gear units, X series – bucket elevator drives	200
Helical gear units / bevel-helical gear units, X series – agitator drives	201
Helical gear units / bevel-helical gear units, X series – hoist drives	202
Helical gear units / bevel-helical gear units, MC series	203
Helical gear units, MACC series	204
Helical gear units, M1N series	205
Helical gear units / bevel-helical gear units, MD series	206

4.2 Planetary gearmotors

Planetary gearmotors, P series	207
--------------------------------	-----

4.3 Planetary gear units

Bevel-helical planetary gear units, P-X series	208
Planetary gear units, XP series	209

4.4 Segmented girth gears

210

4.5 Explosion-proof industrial gear units

212

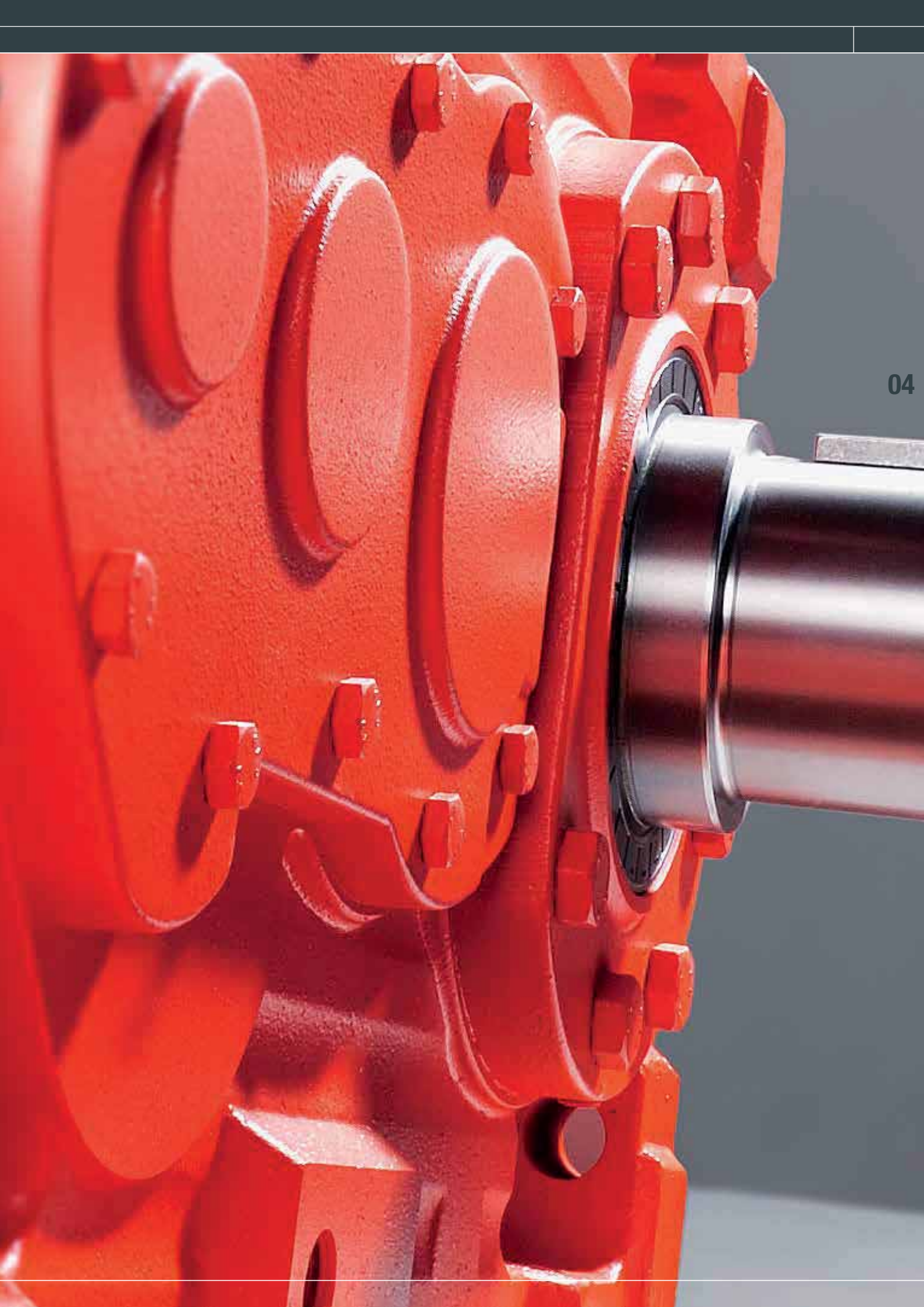

4.1 Helical gear units / bevel-helical gear units

X series



Features	<ul style="list-style-type: none"> – Independent industrial gear unit platform with 23 sizes – Single-piece or split gear unit housings – Invertible gear unit housings – Universal mounting positions – Distinctive modular concept technology – Diverse predefined optional equipment and options – Customer-specific adaptations – Areas of application: conveyor systems in various industries, mixers, and agitators, etc. 		
Advantages	<ul style="list-style-type: none"> – Reduced costs and weight due to high power density and finely stepped sizes – Extremely robust gear unit housing – Effective cooling systems – Flexible mounting options 		
Gear unit design	Stages	Gear ratio <i>i</i>	Nominal torque M_{N2} kNm ¹⁾
Helical gear units X.F	2, 3 and 4 stages	6.3 – 450	6.8 – 475
Bevel-helical gear units X.K	2, 3 and 4 stages	6.3 – 450	6.8 – 475
Bevel-helical gear units X.T	3 and 4 stages	12.5 – 450	6.8 – 175

¹⁾ A project-specific solution can be offered on request for the torque range from 475 to 1200 kNm.
Please contact your local sales representative.

X series – conveyor drives



04

Features	<ul style="list-style-type: none"> – Gear unit consists of the tried and tested components of the X series – Three-stage bevel-helical gear unit with increased housing surface area for improved heat dissipation – Increased cooling capacity due to efficient fan concept – Comprehensive range of accessories of the X series – Versatile shaft concepts – Taconite sealing system – Breather valve from Des-Case – Pressure lubrication and splash lubrication available – Also available in ATEX design – Standard backstop, torque limiting backstop optionally available – Available as a complete package, e.g. including motor, brake, swing base or base frame, mechanical coupling, hydraulic coupling, flange coupling, condition monitoring, etc. 		
Advantages	<ul style="list-style-type: none"> – Efficient cooling concept eliminates the need for external cooling units and a larger gear unit – Reliability especially in harsh environments – Simplified maintenance – Two-piece housings 		
Gear unit design	Stages	Gear ratio i	Nominal torque M_{N2} kNm
Bevel-helical gear units X3K../HT/B	3 stages	12.5 – 90	58 – 475

4.1 Helical gear units / bevel-helical gear units

X series – bucket elevator drives



Features

- 19 sizes
- Based on the X series with the successful gearmotor from SEW-EURODRIVE as auxiliary drive
- Auxiliary drive adapter with overrunning clutch and incremental encoder
- Mounted backstop
- Radial labyrinth seal on input and output shafts
- Areas of application: conveyor systems in the most various industries, in particular for bucket elevators in bulk material handling applications

Advantages

- All drive components are perfectly matched
- Reliability thanks to speed monitoring
- High availability thanks to modular concept
- Extensive optional equipment available on request

Gear unit design

	Stages	Gear ratio i	Nominal torque M_{N2} kNm
Bevel-helical gear units X3K.B..	3 stages	28 – 80	6.8 – 270

X series – agitator drives



04

Features	<ul style="list-style-type: none"> – 8 sizes, consisting of the tried and tested components of the X series – Application-specific rolling bearing concepts for various load requirements, in particular for absorbing external forces and bending moments – Three-stage helical gear unit design with special vertical housing for absorbing external forces and bending moments, and for optimized heat dissipation – Modular helical and bevel-helical gear unit design based on the universal housing of the X series can be used universally – Foot-mounted and flange-mounted designs available – Efficient sealing systems including drywell seal – Available with pressure lubrication or oil bath lubrication – Also available in ATEX design – Areas of application: agitators, surface aerators, flotation cells, etc. 		
Advantages	<ul style="list-style-type: none"> – Gear units are perfectly designed for agitator applications – High availability due to modular and world-wide used X series – Consumption of high loads directly on the gear shaft possible. The systematic use of additional rolling bearings in the application is not necessary. 		
Gear unit design	Stages	Gear ratio i	Nominal torque M_{N2} kNm
Helical gear units with vertical housing	3 stages	20 – 100	22 – 90
Helical and bevel-helical gear units with universal housing	2 to 4 stages	6.3 – 450	22 – 90

4.1 Helical gear units / bevel-helical gear units

X series – hoist drives



Features	<ul style="list-style-type: none"> – 11 gear unit sizes with extended center distances – Single-piece housing – Standardized brake mounting bracket for mounting to the gear unit housing – Designs with foot or torque arm available – Solid shaft or hollow shaft available – Optional reinforced shaft with spherical roller bearing, suited for high radial loads and for using a flange coupling – Oil dipstick, oil drain valve, etc. – Areas of application: process cranes, port cranes, etc. 		
Advantages	<ul style="list-style-type: none"> – Gear unit housing is perfectly designed for hoist applications – Gear unit selection with exact load spectrum calculations – “U”-shaped gear unit arrangement makes many motor and rope drum combinations possible as the center distances are enlarged 		
Gear unit design	Stages	Gear ratio i	Nominal torque M_{N2} kNm
Helical gear unit	3 to 4 stages	14 – 250	12.8 – 112

MC series



04

Features

- Independent industrial gear unit series with 8 sizes
- Modular concept
- Special solutions can be implemented
- Block housing without parting line
- Universal mounting positions
- All commercially available connection elements are possible at the input and output
- EBD concept with predefined output bearing types depending on the requirement profile and the application
- Optional variable flange geometries and drywell design
- Areas of application: conveyor systems in various industries, mixers and agitators, shredders and crushers, etc.

Advantages

- High power density
- Sturdy unit due to block housing

Gear unit design	Stages	Gear ratio i	Nominal torque M_{N2} kNm
Helical gear units MC.P.	2 and 3 stages	7.1 – 112	6 – 65
Bevel-helical gear units MC.R..	2 and 3 stages	7.1 – 112	6 – 65

4.1 Helical gear units / bevel-helical gear units

MACC series – dry cooling tower



Features

- 5 sizes
- Improved extended housing for motor
- Drywell
- Shaft end pump for pressure lubrication
- Cooling fan
- Backstop, internal design
- Areas of application:
in air-cooled condensers or dry cooling towers of refineries, power plants, steel production plants, petrochemical production plants and paper mills.
- Optional:
 - On request: special gear ratio
 - Explosion protection

Advantages

- Optimized thermal rating
- High degree of housing stiffness
- High permitted axial load on output shafts
- Reliable surface treatment for use under aggressive ambient conditions

Gear unit design MACC series	H	W	L	Gear ratio <i>i</i>	Nominal torque M_{N2} kNm
05	484	480	897	9 – 25	21
06	516	530	992		28
07	540	570	1 055		37
08	585.5	716	1 187		51
09	606	730	1 267		66

M1..N series



04

Features

- 12 sizes
- Foot-mounted helical gear units
- Oil heater available
- Sealing system also for harsh conditions
- Cooling with fan or cooling coil
- Rigid housing design for thermal efficiency and stability
- Optional accessories available
- Areas of application: pump drives or rollers and refiners in the paper industry

Advantages

- Very easy maintenance due to horizontally split housing design
- Optimized thermal rating
- Gear unit for smaller gear ratios for increased energy efficiency and cost-effectiveness in many applications

Gear unit design	Stages	Gear ratio i	Nominal torque M_{N2} kNm
Helical gear units M1..N	1 stage	1 – 7.1	0.5 – 248

4.1 Helical gear units / bevel-helical gear units

MD series



Features

- 17 sizes
- Welded steel housing
- Bearing concepts for highest loads
- Splash lubrication, bath lubrication, and pressure lubrication
- Various sealing systems, such as radial labyrinth seal (Taconite)
- Output shaft variants:
 - Splined solid shaft
 - Solid shaft with key
 - Other designs on request
- Areas of application: Mill drives, bridge drives, roller drives, hoist drives

Advantages

- Simple installation and startup
- High degree of reliability
- Very easy maintenance due to horizontally split housing design
- The comprehensive gear unit concept with finely stepped sizes and wide gear ratio range allows for implementing customized solutions that ideally meet the requirements of the application
- As a complete drive package with motor, couplings, brake, steel construction, etc., the MD series is seamlessly integrated into the system solutions from SEW-EURODRIVE

Gear unit design	Stages	Gear ratio i	Nominal torque M_{N2} kNm
Helical gear units MD.F.	2, 3 and 4 stages	5.6 – 315	528 – 2 584
Bevel-helical gear units MD.K..	3, 4 and 5 stages	14 – 1 600	561 – 2 584

4.2 Planetary gearmotors

P series



Features	<ul style="list-style-type: none"> – 11 sizes – Transmission of high torques for powerful movement of large quantities with torque increase – Standardized output shaft variants: <ul style="list-style-type: none"> - Solid shaft with splined connection - Hollow shaft with splined connection - Smooth solid shaft – Particularly compact design for limited space – Primary gear units in helical and bevel-helical version can be combined with the planetary gear unit – Areas of application: construction materials industry, cement industry, process engineering, steel industry, materials handling, and waste water industry 		
Advantages	<ul style="list-style-type: none"> – Perfectly matched units (gear unit and motor) – Large range of options due to the SEW-EURODRIVE modular concept – Short, compact design as there is no need for couplings and adapter flanges – Standardized units for ideal cost/benefit ratio and short delivery times – High gear ratios possible 		
Gear unit design	Stages	Gear ratio i	Nominal torque M_{N2} kNm
Helical planetary gear units (gearmotors) P.RF..	4 and 5 stages	100 – 4 000	25 – 631
Bevel-helical planetary gear units (gearmotors) P.KF..	5 stages	140 – 4 000	25 – 631

4.3 Planetary gear units

P-X series



Features

- 11 sizes
- Gear ratio range from $i = 28$
- High transmittable torque and very compact design
- Weight-optimized drive
- Invertible housing
- High thermal rating
- Shared oil chamber
- Areas of application: Apron feeders, bucket-wheel reclaimers, boom drives, chip board plants

Advantages

- Sealing systems and lubrication variants are available
- Reduced space and weight due to motor scoop or motor adapter for harsh environments
- Reduced costs as no replacement gear unit is needed (invertible housing)
- Can be used at low temperatures

Gear unit design	Stages	Gear ratio i	Nominal torque M_{N2} kNm
Bevel-helical planetary gear units P-X	3 and 4 stages	28 – 550	37 – 550

XP series



04

Features	<ul style="list-style-type: none"> – 13 sizes – Transmission of high torques – Suitable for high motor power – High power density – Bevel preliminary stage – Helical preliminary stage – Different coupling variants – Various mounting positions – Can be combined with a primary gear unit – Areas of application: materials handling, raw material processing, food industry, sugar industry, paper industry, raw material extraction 		
Advantages	<ul style="list-style-type: none"> – Maximum flexibility makes for customized solutions – Gear ratio according to customer request – Wide range of equipment options 		
Gear unit design	Stages	Gear ratio i	Nominal torque M_{N2} kNm
Planetary gear units XP.	2, 3 and 4 stages	22 – 3 600 ¹⁾	600 – 5 200

¹⁾ In combination with primary gear units from the modular system for standard gear units of SEW-EURODRIVE

We offer tailor-made project solutions on request.

4.4 Segmented girth gears

Segmented girth gears



Segmented girth gears

Features

- Girth gear pitch diameter up to about 16 m*
- Maximum width 600 mm
- Maximum power 4000 kW per pinion
- Maximum pitch line velocity 6 m/s
- Girth gear module 20, 25, 30 and 50 mm, further sizes on request
- Calculated according to ISO 6336 (AGMA on request), DIN 3990

Advantages

Segmented girth gears

1. Easy casting

The design of the feeders and the use of heat sinks guarantee a seamless casting quality even with critical segments.

2. Convenient handling

– The handling of individual segments and component groups is simplified both in the factory and at the construction site.

- No need for special transportation arrangements: segmented girth gears can be transported in standard containers.

3. Optimized quality assurance

– The minimized size brings also cost advantages when it comes to the checking of individual blanks.

– Flawless blanks can be used without additional welding or oversizing.

4. Precise pitch accuracy

– The segmented girth gears from SEW-EURODRIVE guarantee an initial pitch accuracy of ISO 8 (AGMA 9).

– Because of the high pitch accuracy, the vibrations of the girth gears are kept to a minimum.

5. Easy replacement

If a segment is damaged, it can be exchanged without dismantling the entire ring.

6. Reduced weight

– ADI** has an over-average contact fatigue strength due to its cold work hardening properties.

– These properties combined with an appropriate girth gear size enable a compact and lighter design compared to the conventional solution.

– Reduced weight is important for all handling tasks, in particular for mounting efforts

7. Increased service life

With the correct dimensioning, load and lubrication, an ADI** girth gear is nearly wear-free.

8. Shorter delivery time

The small segments allow for fast production and short delivery times.

* Larger diameters are possible. Contact SEW-EURODRIVE.

** Bainitic ductile iron



Project planning

Thanks to their remarkable material properties, girth gears made of ADI** can have less than half the weight of girth gears made of conventional materials that offer the same performance and safety. Project planning for girth gears by SEW-EURODRIVE is therefore an important requirement for creating customer benefits. The high degree of segmentation ensures that individual customer requirements can be met in an ideal way.

Applications

Example: mill / application size examples

- Power rating: up to approx. 15 MW
- Diameter: up to approx. 16 m
- Assembly: flange
- Speed of rotation: high (10 to 20 min⁻¹)

Example: rotary kiln / application size examples

- Power rating: up to approx. 1 MW
- Diameter: up to approx. 9 m
- Assembly: leaf springs
- Speed of rotation: low (1 to 2 min⁻¹)

Possible scope of delivery

- Segmented girth gears
- Drive pinion and, if required, pedestal bearing
- Fastening parts for the girth gear: mounting springs or mounting flange
- Main gear unit
- Motors
- Auxiliary drives
- Lubrication system
- Foundation or base frame
- Couplings and covers
- Condition monitoring
- Installation as well as startup of the whole drive system

4.5 Explosion-proof industrial gear units

Explosion-proof industrial gear units

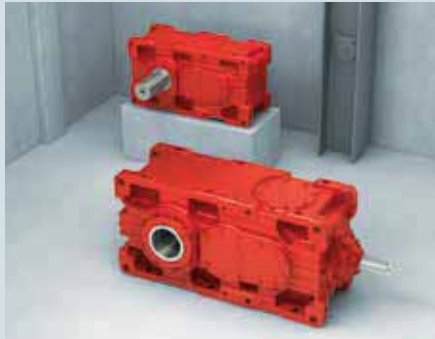

Explosion protection according to ATEX

ATEX designs of industrial gear units

- X series
- X series – agitator drives
- P series
- P-X series

Gear units comply with Directive 2014/34/EU (ATEX), equipment group II, categories 2G, 2D, 3G or 3D for use in zones 1, 2, 21 or 22. The X series is also available for equipment group I, category M2.

- For use on the European market
- Accepted in Russia in conjunction with EAC-Ex certificates

Type of protection

Non-electrical equipment for use in potentially explosive atmospheres is marked with “h” according to EN ISO 80079-36 and -37.

05

DECENTRALIZED DRIVES/ MECHATRONICS

5.1 Gearmotors with inverter

MOVIMOT®	216
Field distributors and fieldbus interfaces, NEW: Z.9	220

5.2 Energy-efficient mechatronic drives

DRC.. electronic motors	224
MOVIGEAR® mechatronic drive unit	226
Installation topologies:	
- With SNI controller	228
- With SEW-EURODRIVE system bus controller	229
- Binary	230
- With AS-Interface	231
- Centralized: with control cabinet inverter	232
Option "external braking resistor" mounting kit for MOVIGEAR® and DRC.. electronic motors	234
Option GBG – local keypad for MOVIGEAR® / DRC.. electronic motors	235
NEW: Optional radial oil seal	
Premium Sine Seal	236

5.3 Gearmotor with motor starter

MOVI-SWITCH®	238
--------------	-----

5.4 Decentralized extra-low voltage servo drive

CMP.. ELVCD®	239
--------------	-----

5.5 ECDriveS®

240



5.1 Gearmotors with MOVIMOT® inverter





Gearmotor with inverter



MOVIMOT®

Speed range min ⁻¹	Voltage V	Connection	Power kW	Torque Nm	Motor type
280 – 1 400 (1 700) 300 – 1 500	3× 380 – 500	λ	0.37 – 4.0	2.52 – 27.3 2.35 – 25.5	DRS.., DRE.., DRN.. DRE..J, DRU..J
290 – 2 900 300 – 2 610	3× 380 – 500	△	0.55 – 4.0 0.37 – 4.0	1.81 – 13.2 1.35 – 14.6	DRS.., DRE.., DRN.. DRE..J, DRU..J
280 – 1 700	3× 200 – 240	λ λ	0.37 – 2.2	2.08 – 12.4	DRE.., DRS..

Features	<ul style="list-style-type: none"> – The product of success in decentralized drive technology: an ingenious combination of a gearmotor and an integrated digital frequency inverter – Available in all standard gearmotor variants and mounting positions, with or without brake – MOVIMOT® of the D series can be combined with our DR.. motors series with various efficiency levels as standard: <ul style="list-style-type: none"> - with DRU.. motors = IE4 Super Premium Efficiency - with DRN.. motors = IE3 Premium Efficiency - with DRE.. motors = IE2 High Efficiency <p>In combination with the DRE.., DRN.., and DRU.. motor series, MOVIMOT® complies with the highest efficiency class IES2 for drive systems according to IEC 61800-9-2 (former EN 50598-2).</p>
Degrees of protection	IP54, optionally IP55, IP65 or IP66
Ambient temperature	–30 °C/–20 °C to +40 °C (depending on the motor)
Control via binary signals	Inputs for CW/stop, CCW/stop, setpoint changeover, potential-free signal relay, fixed setpoints, acceleration and deceleration ramps
Control via fieldbus communication	<p>In combination with fieldbus interfaces with and without minicontroller PROFIBUS, INTERBUS, EtherNet/IP™, DeviceNet™, AS-Interface, PROFINET IO and NEW SBus^{PLUS}/EtherCAT® (see page 220)</p> <p>Startup modes: Easy, Expert and Central via PLC</p>

Use in stand-alone applications	In combination with the following options: <ul style="list-style-type: none"> – MLU..A: Local DC 24 V supply – MLG.1A: Local setpoint adjuster with DC 24 V supply – MBG11A: Speed control module for setting and displaying the setpoint frequency – MWA21A: Setpoint converter for interfacing analog setpoints (0 – 10 V, 0 – 20 mA, 4 – 20 mA) to RS485 			
Use in decentralized installation	In combination with the field distributors: <ul style="list-style-type: none"> – MF.../Z.3. – MF.../Z.6. – MF.../.../Z.7. – MF.../.../Z.8. – MF.../.../Z.9. – and associated hybrid cables 			
Diagnostics	3-color LED to indicate operating and fault states via diagnostic interface, serial interface RS-485 and MDG11A option or PC			
Approval	IEC or 			
	MOVIMOT® with motor type DRE.. (IE2) already meets the requirements for the highest system efficiency class IES2 for a drive system (PDS: Power Drive System) of the international IEC 61800-9-2 standard (former EN 50598-2). MOVIMOT® is also available with IE3 and IE4 motors.			
safetyDRIVE Functional safety 	With the optional safety package, you can implement the following requirements: <ul style="list-style-type: none"> – Performance level d according to EN ISO 13849-1 – SIL 2 according to IEC 61 800-5-2 Safety function: optional with STO safety function (Safe Torque Off) up to PL d according to EN ISO 13849-1			
Features of MOVIMOT® in category 3D 	<ul style="list-style-type: none"> – Design: with EDR.. motors and integrated frequency inverter – Specifically for use in potentially explosive dust/air mixtures – Power range from 0.25 to 3.0 kW, with and without brake for connection voltages of 400 to 500 V 			
Nominal speed min⁻¹	Voltage V	Connection	Power rating kW	Torque Nm
1 400	3× 400 – 500	λ	0.25 – 3.0	1.7 – 20.5
2 900	3× 400 – 500	△	0.37 – 3.0	1.2 – 9.9

5.1 Gearmotors with MOVIMOT® inverter

MOVIMOT® communication option AS-Interface



Simple and cost-effective fieldbus connection



Features

- MLK30A binary slave
 - The AS-Interface slave works like a module with 4 inputs and 4 outputs
 - Max. 31 AS-Interface stations
- MLK31A double slave
 - Double slave according to the AS-Interface specification 3.0
 - Several speed setpoints and ramps
 - Parameterizable via AS-Interface: Reading and writing of MOVIMOT® parameters and display values
 - Max. 31 AS-Interface stations
- **NEW:** MLK32A binary slave
 - Slave according to the AS-Interface specification 3.0
 - Several speed setpoints and ramps
 - Max. 62 AS-Interface stations
- Optional with safety function STO (Safe Torque Off) up to PL d according to EN ISO 13849-1
- 2 sensor inputs connected directly via the AS-Interface nodes (for all MLK types)

Possible applications

- Simple fieldbus connection
- For applications that require soft startup behavior
- Signal feedback of connected sensors
- For applications that require a lot of space
- Individual parameter access in conjunction with MLK31 directly via AS-Interface

Application examples

- Roller conveyors
- Pallet conveyors
- Accumulating roller conveyors
- Rotary tables

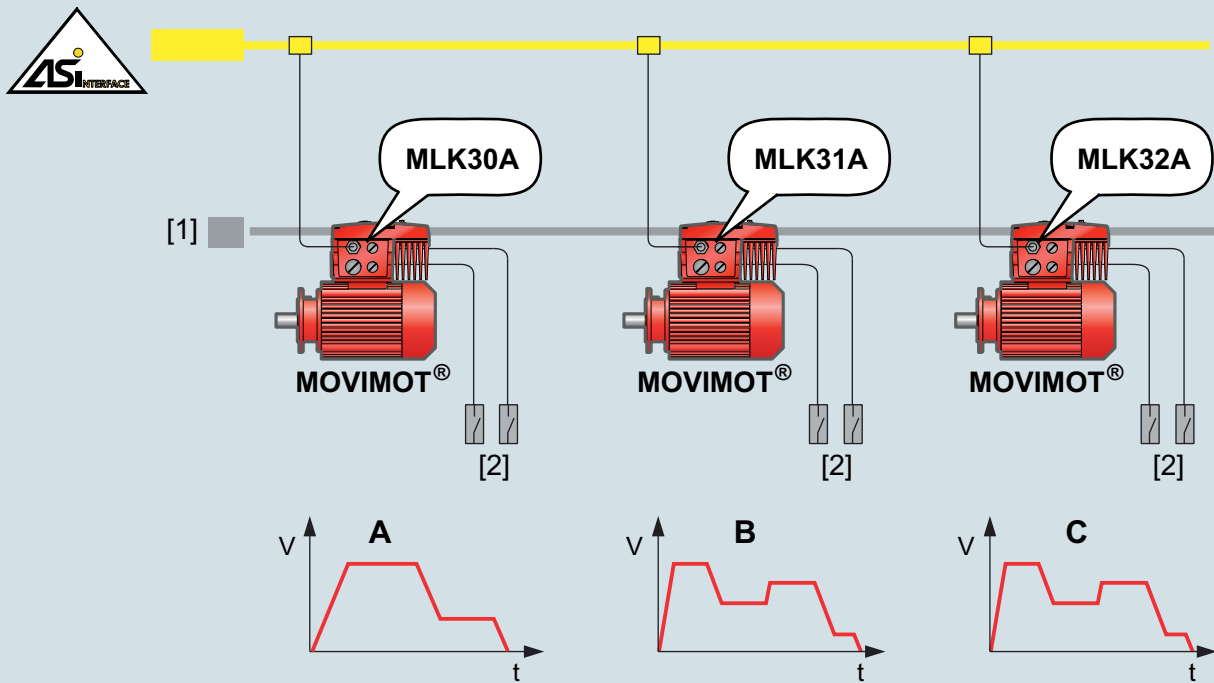

05

[1] Supply system

[2] Sensors

A MOVIMOT® drive with MLK30A

B MOVIMOT® drive with MLK31A

(several speed setpoints and ramps, parameterizable via AS-Interface, max. 31 AS-Interface stations)

C MOVIMOT® drive with MLK32A

(several speed setpoints and ramps, max. 62 AS-Interface stations, STO optional)

5.1 Gearmotors with MOVIMOT® inverter

Fieldbus interfaces, field distributors and cable systems



MF.. and MQ.. fieldbus interfaces

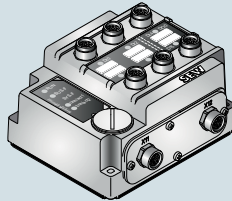

MFE52 fieldbus interface for PROFINET IO

Features

- Connection of MOVIMOT® and MOVI-SWITCH® drives to the standardized fieldbus systems PROFIBUS, INTERBUS, DeviceNet™, AS-Interface, PROFINET IO, SBus^{PLUS}/EtherCAT®, and **NEW:** EtherNet/IP™
- Fieldbus interfaces are based on a module terminal box with connecting terminals and a pluggable fieldbus module; these fieldbus interfaces can be mounted directly on the drive, in the field, or in the field distributor
- The variable-speed MOVIMOT® drive is connected to the bus using terminals; additional sensors, actuators or MOVI-SWITCH® gearmotors without closed-loop control can be connected to the bus either using terminals or M12 plugs, depending on the configuration.
- Easy fault diagnostics via bus in the event of a malfunction by means of diagnostic interfaces and LED signals
- Reading sensor signals
- Controlling actuators via digital input and output terminals
- IP65 degree of protection
- Option package: IP66 degree of protection, stainless steel cable glands, pressure compensation fitting, M12 metal plug for fieldbus modules with M12 plug connectors

In addition, optionally integrated controller with the following functions:

- Programmable via IPOS^{plus}®
- Simple positioning with EI76 incremental encoder
- Integrated I/O preprocessing and timing elements
- Protocol modification

Options for MF.. / MQ.. fieldbus interfaces

- The **MFG11A keypad** is plugged onto any MFZ.. connection module instead of a fieldbus interface, and so allows manual control of a MOVIMOT® drive
- **DBG60B keypad** for manually controlling MOVIMOT® drives; additionally, the process data words can be displayed in monitor mode; direct connection to the diagnostic interface of MOVIMOT® or the MF../MQ.. fieldbus interface

Hybrid cables

- Cables that combine energy transfer, control voltage, and communication in one cable sheath (SEW-EURODRIVE in-house development) ensure optimum EMC shielding and impedances
- The hybrid cable for connecting MOVIMOT® units and field distributors is at the same time the communication interface, supply and control voltage connection in one cable and is supplied as a prefabricated cable with a plug-in connection
- MOVIMOT® drives fitted with hybrid cables can be connected to the field distributor in a matter of seconds – ready to operate
- Simple handling in case of service: The plug can be disconnected without any danger, the drive can be replaced and the new drive re-connected quickly
- Ideal for all systems with high demands on availability



NEW: Z.9 field distributors with PROFINET communication

Fieldbus/inverter assignment = 1:3

Features

Z.9 field distributor with MFE52B fieldbus module for PROFINET IO

- For three MOVIMOT® inverters 0.37 kW – 1.5 kW
- Star or delta connection switchable
- Pluggable motor connection (length 15 m)
- Optional internal braking resistor
- Optional maintenance switch (with or without feedback)

Gearmotors in various designs

- Motor power ratings 0.37 kW – 1.5 kW
- Optional brake
- Optional temperature switch (TH)

Fieldbus/inverter assignment = 1:3

- One communication module for three drives
- 24 V/400 V parallel & daisy chain wiring
- 6 DI allow for 2 initiators per axis

Application examples

Conveying various loads

- Start/stop and speed adjustments via bus
- Non-time-critical movement without positioning accuracy
- 1 to 2 initiators per conveyor unit

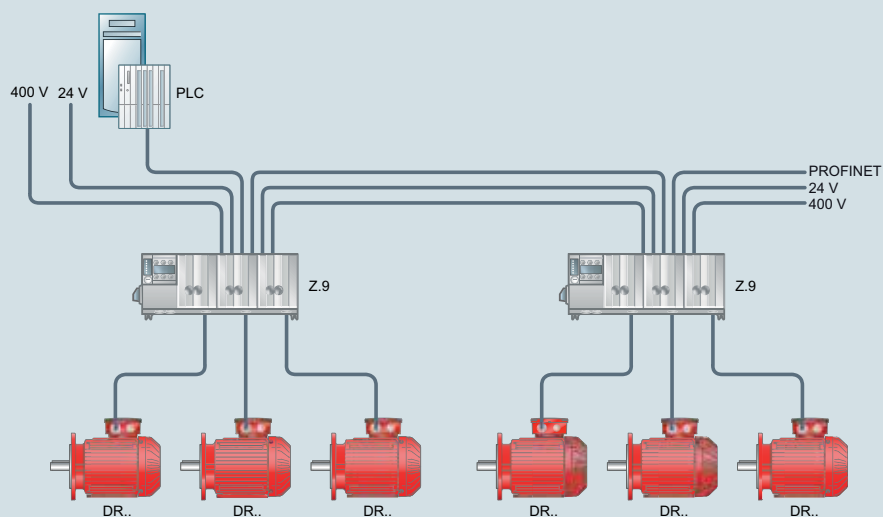

5.1 Gearmotors with MOVIMOT® inverter

Fieldbus interfaces, field distributors and cable systems

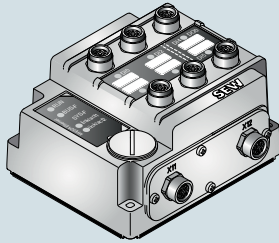

MFE62A EtherNet/IP™ fieldbus interface

Features

- Connection of MOVIMOT® drives to an EtherNet/IP™ fieldbus system
- Compatible with all existing SEW-EURODRIVE field distributors
- Reading-in of sensor signals via M12 plug connectors
- Control of actuators via M12 plug connectors
- Configurable I/Os (4I/2O or 6I/0O)
- Ideal for retrofitting DeviceNet™ systems
- Supports the DLR redundancy protocol
- Degree of protection IP65

Seamless networking

- MFE62A allows for easy and economical connectivity between decentralized drives and EtherNet/IP™ masters
- Flexibly adjustable process data configuration



MFE72A SBus^{PLUS} / EtherCAT[®] fieldbus interface

Features

- Connection of MOVIMOT[®] drives to an SBus^{PLUS} / EtherCAT[®] fieldbus system
- Compatible with all existing SEW-EURODRIVE field distributors
- Reading-in of sensor signals via M12 plug connectors
- Control of actuators via M12 plug connectors
- IO update cycle ≥ 1 ms
- Selectable number of process data (4PD/10PD)
- Degree of protection IP65

Seamless networking

- The MFE72A fieldbus interface enables simple and efficient communication between decentralized drives and SBus^{PLUS} / EtherCAT[®] masters
- Added value due to flexible additional functions such as encoder evaluation and counting input for fast pulse trains

Integrated additional functions

- Integrated encoder evaluation for master-based simple positioning
- Compatible with built-in encoder EI7C from SEW-EURODRIVE
- Counting input for fast pulse trains, e.g. for product identification using a light barrier

5.2 Energy-efficient mechatronic drives

DRC.. electronic motors





Features / advantages

- Combination of a permanent-field synchronous motor with integrated drive electronics in a completely enclosed housing
- High gear unit flexibility due to variable combinations with modular gear unit system of SEW-EURODRIVE
- A highly efficient mechatronic drive unit is generated together with a helical-bevel, helical or parallel-shaft helical gear unit
- The optimized system efficiency offers an energy saving potential of up to 50% and consequently a reduction of the TCO due to innovative technology:
 - Permanent-field synchronous motor instead of asynchronous motor
 - Motor efficiency higher than efficiency class IE4 (Super Premium Efficiency) of IEC 60034
 - Surpasses the highest defined energy efficiency class IES2 according to EN 50598-2 for the system made of motor and electronics
 - Electronics integrated into the motor for optimal functionality and minimal losses
 - Optimized electronic components and intelligent control modes
- Overload capacity of up to 250% for high breakaway and acceleration torques prevent oversizing in static operation and reduces the installed system power
- Universal use due to large control range of 1:2000
- Positioning capability on integrated feedback system
- High degree of protection
- Worldwide use due to the large input voltage and frequency range as well as the compliance with all worldwide energy efficiency regulations
- The systematic development of all components ensures high reliability and a long service life, resulting in a high system availability
- Monitoring functions and maintenance are supported
- Quick and easy installation
- Detailed diagnostic options
- Installation topology with SEW-EURODRIVE controller:
 - SNI: only one cable for power supply and communication; installation effort reduced by up to 60%
 - SBus: for applications with high performance demands
- Installation topology binary or AS-Interface for easy drive functions

safetyDRIVE Functional safety

- Integrated functional safety:
Safe Torque Off (STO) up to PL e according to EN ISO 13849-1

Possible applications	Perfectly suitable for many industries such as beverages and food, automotive and pharmaceutical industry but also airport logistics, intralogistics in general or construction industry.
Application examples	<ul style="list-style-type: none"> – Inclining tracks and hoists – Belt, chain or roller conveyors – Pallet conveyors and palletizers – Rollover machines – Roller conveyors or ascending conveyors – Areas in front of a machine – Drives for positioning and synchronous operation
DRC.. performance classes and designs 	<ul style="list-style-type: none"> – DRC..1 with 2.6 Nm nominal torque (power rating 0.55 kW) – DRC..2 with 7.2 Nm nominal torque (power rating 1.5 kW) – DRC..3 with 14.3 Nm nominal torque (power rating 3 kW) – DRC..4 with 19.1 Nm nominal torque (power rating 4 kW) <p>Speed setting range and positioning performance:</p> <ul style="list-style-type: none"> – Standard control range 1:2000 – Single-turn encoder /ECR – Multi-turn absolute encoder /ACR
Gear unit flexibility	<ul style="list-style-type: none"> – Standard flanges for combination with 7-series gear units from SEW-EURODRIVE – Stand-alone motors with IEC flange
Application options DRC.. electronic motor with optional digital inputs and outputs 	<ul style="list-style-type: none"> – Reading and processing of digital and analog sensor signals decentralized and close to the drive via GIO12B and GIO13B application options – Fast response to changes of the sensor state due to decentralized processing and response – Reduced effort for cabling and installation <p>GIO12B application option</p> <ul style="list-style-type: none"> – 4 digital inputs – 2 digital outputs for actuator control <p>GIO13B application option</p> <ul style="list-style-type: none"> – 4 digital inputs (of which 2 can be used as primary frequency inputs) – 1 digital output – 1 analog input – 1 analog output

5.2 Energy-efficient mechatronic drives

MOVIGEAR®



Features / advantages

- Completely integrated, compact design: Permanent-magnet motor, gear unit and electronics are combined in one mechatronic drive unit
- The optimized system efficiency offers an energy saving potential of up to 50% and consequently a reduction of the TCO due to innovative technology:
 - Permanent-field synchronous motor instead of asynchronous motor
 - Motor efficiency higher than efficiency class IE4 (Super Premium Efficiency) of IEC 60034
 - Surpasses the highest defined energy efficiency class IES2 according to EN 50598-2 for the system made of motor and electronics
 - Helical gearing for extremely compact design and highest efficiency
 - Electronics integrated into the motor for optimal functionality and minimal losses
 - Optimized electronic components and intelligent control modes
- Overload capacity of up to 350% for high breakaway and acceleration torques prevent oversizing in static operation and reduces the installed system power
- High degree of protection
- Worldwide use due to the large input voltage and frequency range as well as the compliance with all worldwide energy efficiency regulations
- The systematic development of all components ensures high reliability and a long service life, resulting in a high system availability
- Monitoring functions and maintenance are supported
- Quick and easy installation
- Detailed diagnostic options
- Installation topology with SEW-EURODRIVE controller:
 - SNI: only one cable for power supply and communication; installation effort reduced by up to 60%
 - SBus: for applications with high performance demands
- Installation topology binary or AS-Interface for easy drive functions

safetyDRIVE Functional safety

- Integrated functional safety:
Safe Torque Off (STO) up to PL e according to EN ISO 13849-1



**University of Applied Sciences of
Kaiserslautern**
Department of Applied Engineering Sciences

**Verified by an independent entity:
Energy-saving potential of up to 50%**

“A comparison of the test results shows a significant efficiency advantage of MOVIGEAR® drives ... over the entire load range.”

Possible applications

Perfectly suitable for many industries such as beverages and food, automotive and pharmaceutical industry but also airport logistics, intralogistics in general or construction industry.

MOVIGEAR® performance classes and designs



MOVIGEAR® is available in two sizes, three performance classes and two mechanical variants:

MOVIGEAR® performance classes

- MGF.2 (torque class: 200 Nm, up to 0.8 kW)
- MGF.4 (torque class: 400 Nm, up to 1.6 kW)
- MGF.4/XT (torque class: 400 Nm with extended continuous torque, up to 2.1 kW)

MOVIGEAR® design types

- MOVIGEAR® with hollow shaft and key
- Size 2 with 35 mm and 40 mm hollow shaft
- Advantages: - Identical customer shaft for MGF..2 and MGF..4
 - Maximum flexibility
 - Perfect for retrofit projects
- MOVIGEAR® with TorqLOC® hollow shaft mounting system

Speed setting range and positioning performance

- Standard control range 1:10
- Extended control range 1:2000
 - Single-turn encoder /ECR
 - Multi-turn absolute encoder /ACR

NEW: Universal design /MU thanks to internal pressure compensation

- Pressure compensation of the gear unit /PG
- Pressure compensation fitting of the electronics /PE

Design for special ambient conditions



- Meets all of the requirements for use in hygienic areas
- Special HP200 surface treatment with optimum anti-adhering properties
 - ECOLAB®-tested chemical and mechanical resistance
 - FDA approval
 - Minimal cleaning effort
- Degree of protection up to IP66
- Perfectly suited for nearly all applications in clean room environments as it complies with all requirements of clean room drives up to air cleanliness class 2 according to ISO 14644-1 (confirmed by Fraunhofer Institute)
- Pressure compensation fitting
- Stainless steel fitting
- Internal pressure compensation

Application options

MOVIGEAR® with optional digital inputs and outputs



- Reading and processing of digital and analog sensor signals decentralized and close to the drive via GIO12B and GIO13B application options
- Fast response to sensor signals due to decentralized processing in the drive
- Reduced effort for cabling and installation

GIO12B application option

- 4 digital inputs
- 2 digital outputs for actuator control

GIO13B application option

- 4 digital inputs (of which 2 can be used as primary frequency inputs)
- 1 digital output
- 1 analog input
- 1 analog output

5.2 Energy-efficient mechatronic drives

Installation topology with SNI controller

Single Line Network Installation

<p>Features</p>	<ul style="list-style-type: none"> - SNI uses the cabling infrastructure of the power supply as the basis for the transmission of communication signals - Easy installation as only supply cables need to be connected - Drive networks can be implemented covering an area of up to 100 m and 10 slaves - Routing of bus cables or 24 V supply to drives not necessary - No risk of hidden faults in the bus cabling - Reduced startup time - Shorter project runtimes/reduction of project costs
<p>Possible applications</p>	<ul style="list-style-type: none"> - Installation topology for easy installation of MOVIGEAR®/DRC.. drive units for conveyor systems that require variable speeds or local positioning - SNI components in combination with actuators MOVIGEAR® and DRC.. in SNI design as extension to process more distributed sensors without additional infrastructure
<p>Application examples</p>	<ul style="list-style-type: none"> - Belt conveyors - Pallet conveyors - Roller and wheel conveyors - Screw conveyors - Container and packaging unit transports - Chain and drag-chain conveyors
<p>SNI components</p>	<ul style="list-style-type: none"> - CSW maintenance switch <ul style="list-style-type: none"> - Possibility to disconnect single SNI actuators individually - Communication to all other actuators is maintained - SNI I/O system CIO: <ul style="list-style-type: none"> - Networking of process-relevant, not directly assigned sensors via SNI infrastructure - Intelligent preprocessing of sensors and integration into the CCU structure

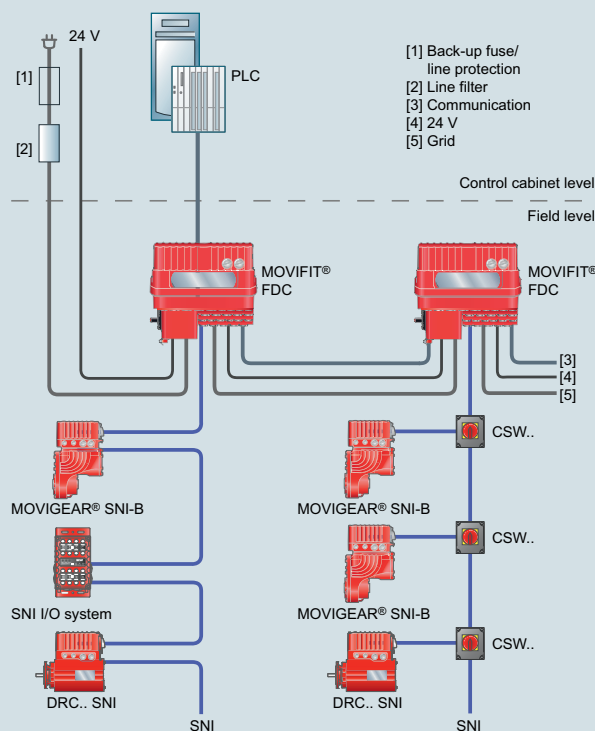

Installation topology with SEW-EURODRIVE system bus controller

SEW-EURODRIVE system bus: high performance and fast bus communication via CAN

Features	<ul style="list-style-type: none"> - Line wiring - Fast communication for short response times - Hybrid cables for minimum installation effort - System bus controller for control cabinet or fieldbus installation with integrated PLC
Possible applications	<ul style="list-style-type: none"> - Installation topology for easy installation of MOVIGEAR®/DRC.. drive units for conveyor systems that are operated dynamically with variable speeds - For forming intelligent function groups - As group drive for phase-synchronous operation
Application examples	<ul style="list-style-type: none"> - Pallet conveyors - Machine-integrated conveyor belts - Feeding conveyors - Synchronized feeder conveyors - Reversing drives

05

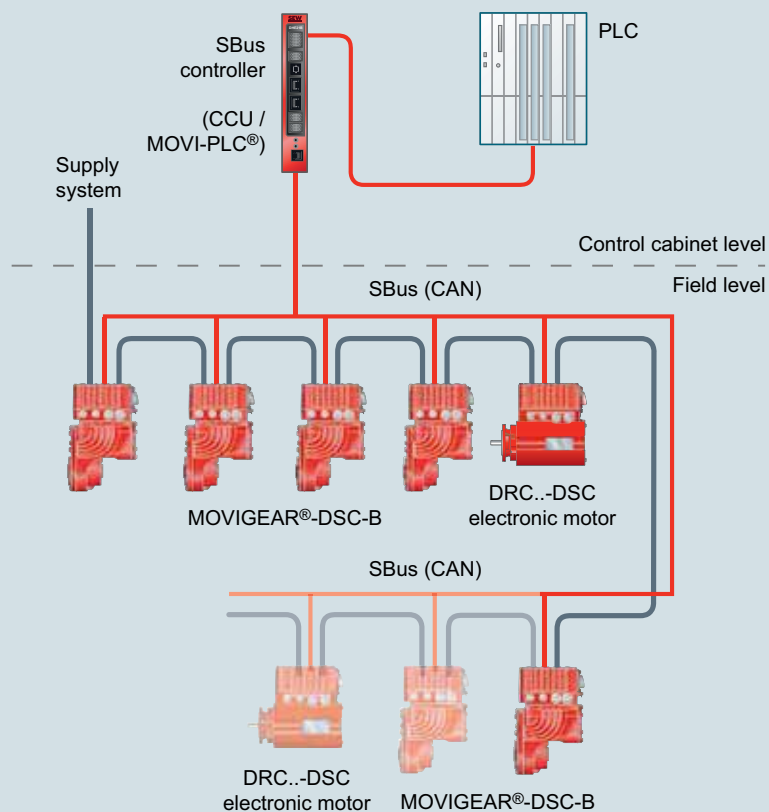

5.2 Energy-efficient mechatronic drives

Binary installation topology

Binary: stand-alone operation

<p>Features</p>	<ul style="list-style-type: none"> - Fixed speeds/ramps can be set using potentiometers or parameterized with software - Central control using discrete signals from a PLC - Can be started up without a PC - 4 digital inputs - 1 relay signal output
<p>Possible applications</p>	<ul style="list-style-type: none"> - Simple stand-alone applications and single applications - For applications that require soft startup behavior - Applications with two fixed speeds - For applications with high breakaway torques - As a replacement for line-powered drives
<p>Application examples</p>	<ul style="list-style-type: none"> - Simple conveyors - Rotary tables - Adjustment drives - Agitators and mixers - Crushers and shredders - Presses

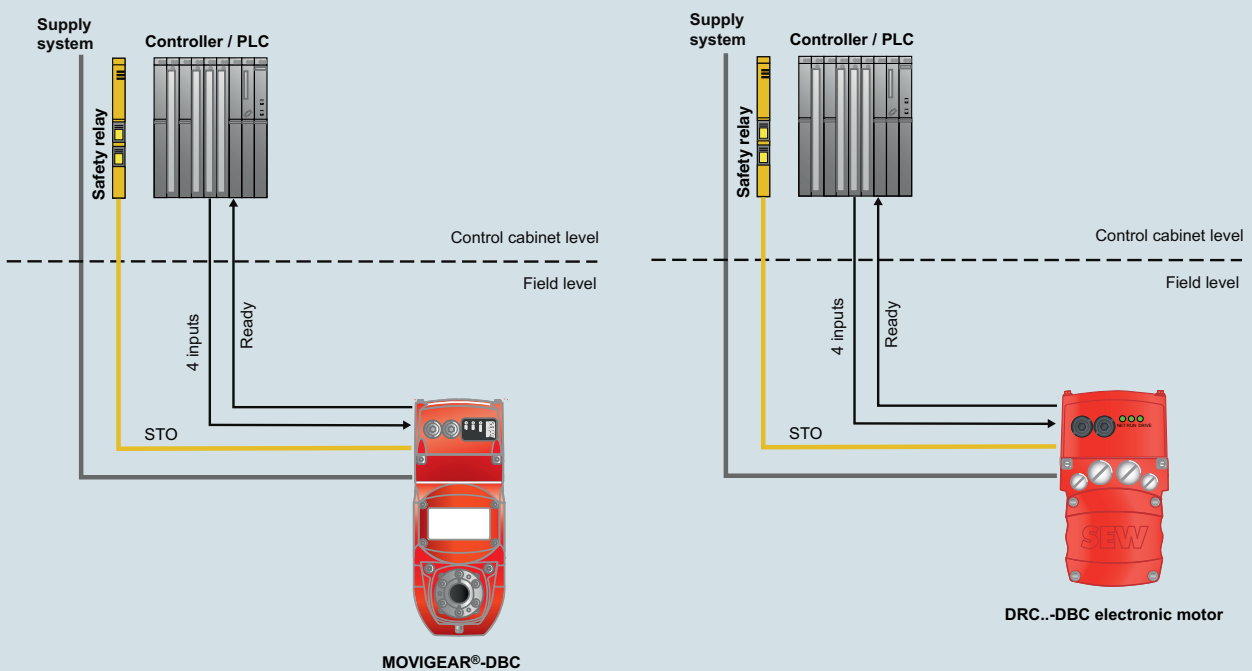

Installation topology with AS-Interface

AS-Interface: simple and economical fieldbus connection

<p>Features</p>	<ul style="list-style-type: none"> - Parameterizable fixed speeds and ramps - 2 designs <ul style="list-style-type: none"> - Binary slave (GLK30) - Double slave (GLK31) - 2 sensor inputs connected directly via the AS-Interface nodes - STO (Safe Torque Off) safety function up to PL e according to EN ISO 13849-1 - 4 digital inputs for local mode - Expanded startup using the diagnostic interface
<p>Possible applications</p>	<ul style="list-style-type: none"> - Simple fieldbus connection - For applications that require soft startup behavior - Signal feedback of connected sensors - For applications that require a lot of space - Individual parameter access in connection with GLK31
<p>Application examples</p>	<ul style="list-style-type: none"> - Accumulating roller conveyors - Roller and wheel conveyors - Pallet conveyors - Rotary tables

05

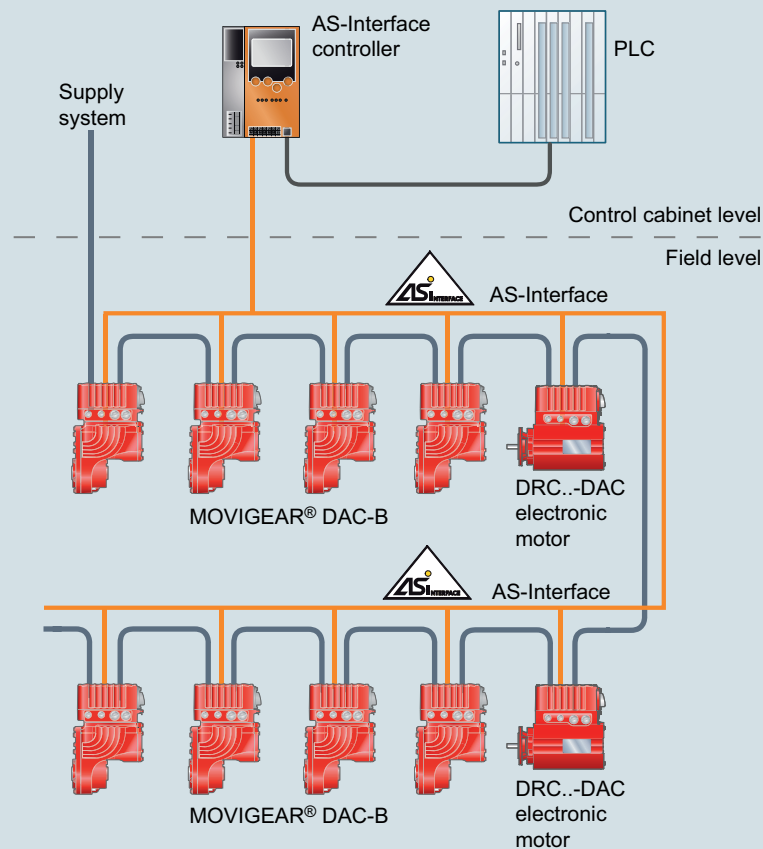

5.2 Energy-efficient mechatronic drives

Central installation topology with control cabinet inverter



Features	<ul style="list-style-type: none"> – MGF.-DSM gearmotor unit as alternative for centralized control cabinet installations – The frequency inverter installed in the control cabinet is connected to the MGF.-DSM drive unit – In combination with MOVITRAC® LTP-B control cabinet inverters easy startup with only two parameters – Parameterizable fixed speeds and ramps – With CCU application controller identical interfaces/functions for speed control as those for decentralized solutions
Possible applications	<ul style="list-style-type: none"> – Flexibility when planning new systems, particularly for replacement and retrofit projects – As drive for applications with high breakaway and starting torques – Conveyor systems with variable speeds – As a drive for applications that require soft and/or defined start-up behavior
Application examples	<ul style="list-style-type: none"> – Transport of bottles, packaging units and containers – Belt conveyors – Screw conveyors

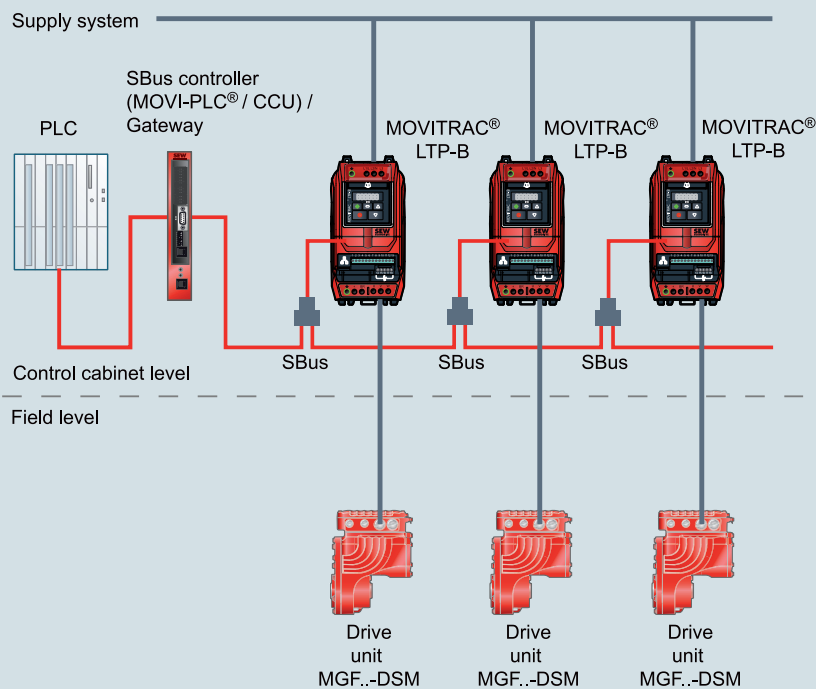

MGF.-DSM performance classes and designs

MGF.-DSM is available in two sizes, three performance classes and two mechanical variants:

MGF.-DSM performance classes

- MGF.2-DSM (torque class: 200 Nm, up to 0.8 kW)
- MGF.4-DSM (torque class: 400 Nm, up to 2.1 kW)
- MGF.4-DSM/XT (torque class: 400 Nm with extended continuous torque, up to 3 kW)

MGF.-DSM design types

- MGF.-DSM with hollow shaft and key
- **NEW:** Size 2 with 35 mm and 40 mm hollow shaft
Advantages: - Identical customer shaft for MGF..2 and MGF..4
 - Maximum flexibility
 - Perfect for retrofit projects
- MGF.-DSM with TorqLOC® hollow shaft mounting system

NEW: Universal design /MU thanks to internal pressure compensation

- Pressure compensation of the gear unit /PG
- Pressure compensation fitting of the electronics /PE

Design for special ambient conditions

- Meets all of the requirements for use in hygienic areas
- Special HP200 surface treatment with optimal anti-adhering properties
 - ECOLAB®-tested chemical and mechanical resistance
 - FDA approval
 - Minimal cleaning effort
- Degree of protection up to IP66
- Perfectly suited for nearly all applications in clean room environments as it complies with all requirements of clean room drives up to air cleanliness class 2 according to ISO 14644-1 (confirmed by Fraunhofer Institute)
- Pressure compensation fitting
- Stainless steel fitting
- Internal pressure compensation

5.2 Energy-efficient mechatronic drives

Option “external braking resistor” mounting kit



For MOVIGEAR® and DRC.. electronic motors

Features

The mounting kit for braking resistors for MOVIGEAR® and the DRC.. electronic motor serves applications with high dynamics and high cycle rates. The mounting kit is available for MOVIGEAR® and electronic motors of size DRC..1 and DRC..2 in two sizes and has the option to install a 100 W or 200 W braking resistor.

GBG option



Local keypad for MOVIGEAR®/DRC.. electronic motors

Features

The GBG local keypad allows to operate the drive without a higher-level controller in two directions of rotations and with two speeds. In addition, errors can be acknowledged on site and DynaStop® or the brake can be released manually.

Drive designs and plug connectors

The GBG10-11A-00 local keypad is intended for use with the following drive units:

- MOVIGEAR® DSC-B
- MOVIGEAR® SNI-B
- MOVIGEAR® DAC-B
- DRC..-DSC electronic motor
- DRC..-SNI electronic motor
- DRC..-DAC electronic motor

For the electrical connection, the drive unit has to be equipped with the M23 motion control plug connector according to the following table.

Design	Connector code	Function
DSC	X5131	M23 motion control, 12-pin, 0°, female
SNI	X5131	M23 motion control, 12-pin, 0°, female
DAC	X5132	M23 motion control, 12-pin, 0°, female

5.2 Energy-efficient mechatronic drives

NEW: Optional radial oil seal “Premium Sine Seal”



**The shaft for twice the service life –
new sealing system for gearmotors**

Features

- Protects the motor against oil (input side)
- Protects the gear unit interior (no leaks)
- Generates less heat at the sealing lip
- Expected service life of about 20 000 h
- No grease required

Operating principle

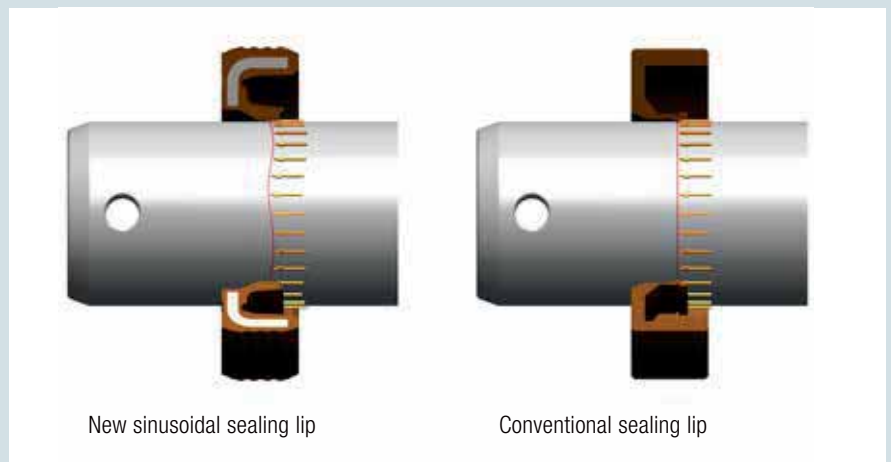

Premium Sine Seal:

- Joint development of SEW-EURODRIVE and Freudenberg Sealing Technologies of a new radial oil seal for the input motor shaft of gearmotors
- The sinusoidal shape supports the transfer of lubricant at the sealing surface
- The advantage of the new Premium Sine Seal is that its sinusoidal sealing lip exhibits substantially increased durability so that elastomer wear is reduced significantly; the elastomer is subject to less thermal strain
- Result: more than twice the service life of conventional oil seals

Advantages	<ul style="list-style-type: none"> – Reduced wear on the sealing lip by about 50% – Expected service life longer by a factor of 2 (compared to other systems on the market), which means longer maintenance intervals – No run-in or wear on the shaft – oil seals can be replaced at the same location – Increased safety against leakage and higher system availability
Available for	<p>The new Premium Sine Seal radial oil seals can optionally be ordered for MOVIGEAR® mechatronic drive units.</p> <p>Can also be ordered as an option for R, F, K, and S gear unit series in combination with AQ.. adapter for mounting CMP.. servomotors together with:</p> <ul style="list-style-type: none"> – R series helical gear units – F series parallel-shaft helical gear units – K series helical-bevel gear units – S series helical-worm gear units – PS.F series planetary servo gear units – BS.F series helical-bevel servo gear units – in preparation for asynchronous DR.. series gearmotors
Areas of application	<p>Applications with dynamic speeds, alternating directions of rotation, and variable load situations, such as</p> <ul style="list-style-type: none"> – Packaging – Food and beverage industry – Wood processing – Baggage handling (airports) – Automotive production – Transport and logistics – Handling and robotics – Processing – and many more

5.3 Gearmotor with MOVI-SWITCH® motor starter

Gearmotor with motor starter



MOVI-SWITCH®

Features	<ul style="list-style-type: none"> – Switching and protection function integrated in the motor terminal box – Compact and robust gearmotor – No further cabling required – No additional control cabinet space is needed – Available in all AC motor and brakemotor combinations of the DR.. series with the matching gear units 		
Number of poles	Power range kW		
	MSW-1E	MSW-1EM	MSW-2S
4	0.37 – 3.0	0.09 – 0.25	0.37 – 3.0
2	0.37 – 3.0	0.12 – 0.37	0.37 – 3.0
6	0.25 – 1.5	–	0.25 – 1.5
Switching function	On/off one direction of rotation		On/off two directions of rotation
Switching element	Contactless star bridge switch		Switching element with contact
Direction of rotation	CW or CCW, depending on the phase sequence		CW and CCW, regardless of the phase sequence
Control	<ul style="list-style-type: none"> – Binary control signals RUN / OK – Connection using 1x M12 plug connector 		<ul style="list-style-type: none"> – Binary control signals CW/CCW / OK – Connection using 2x M12 plug connectors – Alternatively with integrated AS-Interface
	–	Alternatively with integrated AS-Interface	
Brake management	With BGW brake rectifier as standard	With BG brake rectifier as standard	<ul style="list-style-type: none"> – Integrated brake control – Optional external control with BGM brake rectifier
Protection function	Thermal motor protection with integrated evaluation		<ul style="list-style-type: none"> – Thermal motor protection with integrated evaluation – Supply system monitoring (power failure and phase failure)
Degree of protection	IP54, optionally IP55, IP65 or IP66		
Ambient temperature	-25 °C to +40 °C (to +60 °C)		

➔ **More information on**
 – fieldbus interfaces, field distributors, cable systems: page 220

5.4 Decentralized extra-low voltage servo drive



CMP.. ELVCD®

Features

- Compact decentralized installation
- High continuous power and peak power
- Robust design with convection cooling
- Easy installation with DC 48 V extra-low voltage
- All connections are pluggable
- High degree of protection IP65
- UL approval¹⁾
- Integrated braking resistor
- Optional encoder systems and brake
- Flexible gear unit combination
- Integrated engineering through integration into the MOVI-PLC® controller
- Coordinated multi-axis movements can be implemented with our MOVI-PLC® motion and logic controller

05

¹⁾ In preparation

Installation topology with the CMP.. ELVCD® extra-low voltage drive

- CMP.. ELVCD® is supplied with DC 24 V (control) and DC 48 V (power supply).
- The drive is controlled via SBus with a controller from SEW-EURODRIVE, which functions as central head station.
- The controller is responsible for the coordination and the higher-level motion control for all connected drives.
- Depending on the power demands and the synchronicity of the drives, several drives can be connected and supplied via one phase winding.
- The controllers used offer conventional interfaces for higher-level automation levels. The automation system can also be operated independently as a module.

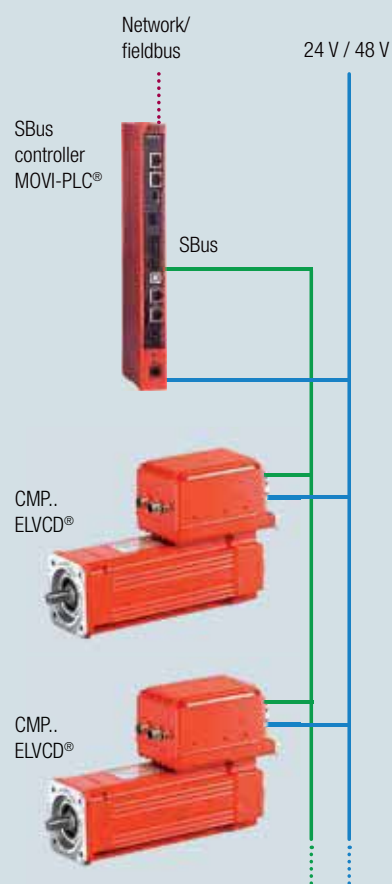

5.5 ECDriveS® drive system

NEW: ECDriveS® drive system for light-duty material handling technology



Just connect and you're done: "easy drive"

Features

- ECDriveS® stands for Electronically Commutated Drive System:
 - Brushless DC gearmotor
 - Integrated directly in the conveyor roller and can be used universally
- Simple, efficient and cost-cutting drive solution for roller conveyors:
 - Just connect and you're done: "easy drive"
- DC drives – optimized for the lower power range of roller conveyors used in light-duty materials handling technology
- Easy to use
- High degree of flexibility
- Simple integration and startup
- Impressive durability and long service life
- External commutation electronics with Ethernet-based zone control or binary control; the Ethernet control is characterized by an integrated conveyor logic capable of decentralized implementation of zero pressure accumulation and many other handling tasks
- 240% overload capacity at 40 W S1 power
- Optimized gear unit design for long service life also in case of high utilization
- Precise positioning of the material to be conveyed thanks to an integrated encoder

Possible applications

- Light-load conveyor technology up to 50 kg
- Perfectly suitable for many industries, such as distribution and logistics, food and beverage, automotive, and pharmaceutical industry
- Application examples:
 - Roller conveyors
 - Rotary tables, small lifting equipment, pushers, transfer units
 - Infeed and discharge belts in machinery construction

Technical data

Gearmotor

	Driven roller, ECDriveS® type ECR	Gearmotor, ECDriveS® type ECG
Number of gear ratios i	11	8
Max. speed	0.04 – 5 m/s	8.5 – 645 min ⁻¹
Max. acceleration torque Nm	6.4	9.55
Max. breakaway torque Nm	21	9.6
Nominal current A	2.5	
Maximum current A	7.2	
Protection type	IP54, IP66	IP54
Temperature range	-10 to 40 °C (-30 °C optional)	-10 to 40 °C

Electronics

	Direct fieldbus control, ECDriveS® type ECC-DFC	Direct binary control, ECDriveS® type ECC-DBC
Nominal voltage V	24	
Communication	Ethernet protocols: PROFINET, EtherNet/IP™, Modbus/ TCP, EtherCAT®	3 DIs + error output
Configuration	ECDriveS® PC tool ECShell	– DIP switches – 32 speeds, 16 ramps
Functions	<ul style="list-style-type: none"> – Precise ramps – Positioning – Zero pressure accumulation (ZPA), flex zone, merger, tracking – Torque on demand – Automatic configuration – Automatic sensor detection – Diagnostics 	
Protection type	IP54	IP20

06

INVERTER TECHNOLOGY

6.1 Control cabinet installation

MOVITRAC® LTE-B ⁺ basic inverters	244
MOVITRAC® LTP-B standard inverters	245
MOVITRAC® B standard inverters	246
MOVIDRIVE® B application inverters	248
MOVIAXIS® multi-axis servo inverters	251
MOVIDRIVE® MDR regenerative power supply units	254
effiDRIVE®: energy efficiency in the control cabinet and in servo applications	260

6.2 Wall mounting

MOVI4R-U® basic inverters	
NEW: Power increase	264
MOVITRAC® LTE-B ⁺ basic inverters in IP66	266
MOVITRAC® LTP-B standard inverters in IP55	266

6.3 Decentralized installation: motor starters

NEW: MOVIFIT® compact basic motor starters	268
MOVI-SWITCH® motor starters	269
MOVIFIT® SC motor starters	270

6.4 Decentralized installation: inverters

NEW: MOVIFIT® compact basic inverters	272
MOVIMOT® standard inverters	273
MOVIFIT® MC distributors for MOVIMOT®	274
MOVIFIT® FC inverters	276
MOVIPRO® standard and application inverters	278

6.5 Accessories and options

Software	
MOVITOOLS® engineering software	279
MOVIVISION® plant software	279



6.1 Control cabinet installation

MOVITRAC® LTE-B+ basic inverters



MOVITRAC® LTE-B+



Features	<ul style="list-style-type: none"> – Standard design for installation in the control cabinet in degree of protection IP20/NEMA 1 – Optionally available in degree of protection IP66/NEMA 4x field housing for wall mounting
Line connection	Power range in kW
115 V / 1-phase	0.37 – 1.1
230 V / 1-phase	0.37 – 4.0
230 V / 3-phase	1.5 – 18.5 NEW: Extended power range
400 V / 3-phase	0.75 – 37.0 NEW: Extended power range
Features	<ul style="list-style-type: none"> – Integrated keypad – Integrated PI controller – Integrated emergency mode/fire mode – Integrated SEW-EURODRIVE system bus, CANopen, and Modbus RTU – Preconfigured for corresponding DR.. motor – Energy-saving function – Extra quiet pulsed voltage supply up to 16 kHz – V/f and LVFC® motor control (Light Vector Flux Control) – Operation of synchronous motors with LSPM technology (Line Start Permanent Magnet Motor) – Approved in accordance with UL508
Options	
DFx	Gateways for many standard fieldbus systems
LT BP B	Parameter module for data transmission to/from PC and saving/loading data
LT BG C	Additional keypad for remote operation
LT NF..	Additional line filters for increased requirements on EMC-compliant installation
LT ND..	Additional line chokes for increasing overvoltage protection
LT HD..	Additional output chokes for suppressing interference emission and for very long motor cables

MOVITRAC® LTP-B standard inverters



MOVITRAC® LTP-B



Features	Flexible, simple and safe: Housing protection IP20/NEMA 1 for control cabinet installation
Line connection	Power range in kW
230 V / 1-phase	0.75 – 2.2
230 V / 3-phase	0.75 – 5.5
400 V / 3-phase	0.75 – 11.0
575 V / 3-phase	0.75 – 15.0

→ More information on MOVITRAC® LTP-B with high degree of protection: page 267

6.1 Control cabinet installation

MOVITRAC® B standard inverters



MOVITRAC® B



Features	<ul style="list-style-type: none"> – Compact frequency inverter for space-saving installation for applications in the power range from 0.25 to 75 kW – Its straightforward operation saves time during startup – Versatile device concept – Wide range of communication and expansion options
Line connection	Power range kW
230 V / 1-phase	0.25 – 2.2
230 V / 3-phase	0.25 – 30
400 / 500 V / 3-phase	0.25 – 75
Standard design	Equipped with integrated IPOS® ¹⁾ positioning and sequence control as standard. The standard basic equipment of the devices can be expanded by various options.
Technology version with application modules	<p>In addition to having the characteristics of the standard version, the devices in the technology version provide access to the “simple positioning” application module.</p> <p>Advantages of the “simple positioning” application module:</p> <ul style="list-style-type: none"> – High functionality and user-friendly user interface – Only the parameters needed for the application must be entered – Guided parameterization instead of complicated programming – All motions are controlled directly in MOVITRAC® B
Energy efficiency	<p>There are various options for improving the energy balance when using MOVITRAC® B:</p> <ul style="list-style-type: none"> – Process adaptation – Energy-saving function – DC link coupling as of size 2 – Regenerative power supply as of size 2 in combination with MOVIDRIVE® MDR
	For information on the operation of explosion-proof motors with frequency inverters or drive inverters, refer to page 163.

¹⁾ With reduced command set

Options for MOVITRAC® B

Keypad – FBG11B – DBG60B	Standard keypads for parameterization, data management, startup, and diagnostics: – Pluggable basic keypad – Plain text keypad
UBP11A parameter module	Simple data backup with the possibility of serial startup
Communication modules – FSC11B / FSC12B – FSE24B	– SBus / RS485 / CANopen – EtherCAT®
Fieldbus connections – DFE32B – DFE33B – DFE24B – DFP21B – DFD11B	– PROFINET IO – Modbus TCP / EtherNet/IP™ – EtherCAT® – PROFIBUS DPV1 – DeviceNet™
Extension for inputs and outputs – FIO11B – FIO21B	– Analog module with setpoint input, analog output and RS485 interface – Digital module with 7 digital inputs and SBus connection
MBG11A setpoint adjuster	Remote speed control in the range of -100% to +100%
Interface adapters – UWS11A / UWS21B – USB11A – USM21A	– Interface adapter for connection to a PC via RS232 interface – Interface adapter for connection to a PC via USB interface – Interface adapter for connection to a PC via USB interface
Safe communication – DFS11B – DFS21B	– PROFIsafe via PROFIBUS – PROFIsafe via PROFINET
safetyDRIVE functional safety	Integrated functional safety: STO (Safe Torque Off) safety function up to PL d according to EN ISO 13849-1 The following versions of MOVITRAC® B are available with STO safety function: – 3x AC 230 V: - 0.55 kW to 2.2 kW: in S0 design - 3.7 kW to 75 kW: integrated as standard – 3x AC 400 V: - 0.55 kW to 4 kW: in S0 design - 5.5 kW to 75 kW: integrated as standard – 1x AC 230 V: STO not available
Additional safety options – UCS..B – BST safe brake module	– Safe torque off: STO – Safe stopping: SS1/SS2 – Safe operation stop: SOS – Safe motion: SLA/SLS/SDI – Safe positioning: SLP/SLI – Safe signaling: SCA/SSM – Safe brake control: SBC

6.1 Control cabinet installation

MOVIDRIVE® B application inverters



MOVIDRIVE® B



Features	<ul style="list-style-type: none"> – Powerful drive inverter for dynamic applications with synchronous and asynchronous motors in the power range from 0.55 to 315 kW – Great diversity of applications due to extensive expansion options with technology and communication options
Line connection	Power range in kW
200 / 240 V / 3-phase	1.5 – 37
400 / 500 V / 3-phase	0.55 – 315
Standard design	The devices are equipped with the integrated IPOS ^{plus} ® positioning and sequence control system as standard and can be flexibly expanded using option cards. “00” at the end of the type designation indicates the standard design.
Technology version with application modules	<p>In addition to the features of the standard design, these devices include the “electronic cam” and “internal synchronous operation” technology functions. The application version is indicated by “0T” following the type designation.</p> <p>The devices in technology version also provide access to the application modules. Standardized control programs for solving technically advanced drive tasks, such as synchronized applications, positioning, flying saw, and winding.</p> <p>Advantages of application modules</p> <ul style="list-style-type: none"> – High functionality and intuitive user interface – Only the parameters needed for the application must be entered – Guided parameter setting instead of complicated programming – No lengthy training or familiarization, which means quick project planning and startup – All motions are controlled directly in MOVIDRIVE® B – Decentralized concepts can be implemented more easily
safetyDRIVE functional safety	Integrated functional safety: STO (Safe Torque Off) safety function up to PL d according to EN ISO 13849-1
	For information on the operation of Ex motors with our inverter technology, refer to page 163.

Options for MOVIDRIVE® B

Type designation	
Keypad DBG60B	Keypad for parameterization, data management, startup, and diagnostics
Encoder interfaces DEH11B	<ul style="list-style-type: none"> – Motor encoder connection: TTL, RS422, sin/cos and HIPERFACE® encoders – Distance encoder connection: TTL, RS422, sin/cos and HIPERFACE® encoders
DER11B	<ul style="list-style-type: none"> – Motor encoder connection: Resolver – Distance encoder connection: TTL, RS422, sin/cos and HIPERFACE® encoders
DEH21B	<ul style="list-style-type: none"> – Motor encoder connection TTL, RS422, sin/cos and HIPERFACE® encoders – Distance encoder connection: SSI absolute encoders
DEU21B	<ul style="list-style-type: none"> – Motor encoder connection: TTL, HTL, RS422, sin/cos, HIPERFACE®, SSI, CAN, EnDat 2.1 encoders – Distance encoder connection: TTL, HTL, RS422, sin/cos, HIPERFACE®, SSI, CAN, EnDat 2.1 encoders
DIP11A	<ul style="list-style-type: none"> – Motor encoder connection: TTL, RS422, sin/cos and HIPERFACE® encoders – Distance encoder connection: SSI absolute encoders
DIP11B	<ul style="list-style-type: none"> – Distance encoder connection: SSI absolute encoders – Extension of digital inputs and outputs: 8x inputs, 8x outputs
Fieldbus connections	
– DFE32B / DFE33B	– PROFINET IO / Modbus TCP + EtherNet/IP™
– DFE24B	– EtherCAT®
– DFP21B	– PROFIBUS DPV1
– DFC11B / DFD11B	– CANopen / DeviceNet™
– DFI11B / DFI21B	– INTERBUS / INTERBUS-FOC
– DFS11B / DFS21B	– PROFIsafe via PROFIBUS / PROFIsafe via PROFINET
MOVISAFE® safety monitor	Safe movement/position monitoring, safe inputs and outputs up to PL e according to EN ISO 13849-1 and
– DCS31B	– for “safe motion/position monitoring”
– DCS21B + DFS12B	– for “safe motion/position monitoring and communication” (PROFIsafe/PROFIBUS)
– DCS21B + DFS22B	– for “safe motion/position monitoring and communication” (PROFIsafe/PROFINET)
– DCS32B	– for “safe motion monitoring”
– DCS22B + DFS12B	– for “safe motion/position monitoring and communication” (PROFIsafe/PROFIBUS)
– DCS22B + DFS22B	– for “safe motion/position monitoring and communication” (PROFIsafe/PROFINET)
BST safe brake module	Safe Brake Control (SBC) up to PL d according to EN ISO 13849-1
Extension for inputs and outputs	8x digital inputs and 8x digital outputs; 1x analog differentiation; 2x analog outputs
– DIO11B	
Other	
– DRS11B	– Synchronous operation card
– USB11A	– Interface adapter for connection to a PC via USB interface
– UWS21B	– Interface adapter for connection to a PC via RS232 interface
– USM21A	– Interface adapter for connection to a PC via USB interface

6.1 Control cabinet installation

Options for MOVITRAC® B and MOVIDRIVE® B

MOVI-PLC® standard controller – DHE21B – DHF21B – DHR21B	– MOVI-PLC® standard, Ethernet interface – MOVI-PLC® standard, Ethernet / PROFIBUS / DeviceNet™ interface – MOVI-PLC® standard, Ethernet / PROFINET / Modbus TCP / EtherNet/IP™ interface
MOVI-PLC® advanced controller – DHE41B – DHF41B – DHR41B – External controller: UHX71B	– MOVI-PLC® advanced, Ethernet interface – MOVI-PLC® advanced, Ethernet / PROFIBUS / DeviceNet™ interface – MOVI-PLC® advanced, Ethernet / PROFINET / Modbus TCP / EtherNet/IP™ interface – MOVI-PLC® power: IEC-61131-3 programmable motion and logic controller or – CCU power: parameterizable application controller
MOVITOOLS® MotionStudio engineering software	The MOVITOOLS® MotionStudio program package lets you conveniently start up, set parameters and run diagnostics for MOVITRAC® B frequency inverters and MOVIDRIVE® B application inverters.
Regenerative power supply MOVIDRIVE® MDR60A 15 kW – 160 kW MOVIDRIVE® MDR61B 160 kW – 315 kW	Regenerative power supply can supply multiple devices with power using a central line connection. In regenerative mode, the power is fed back into the supply system. Using MDR60A/MDR61B saves energy and reduces installation work.
BW braking resistors	BW series braking resistors are available for operating MOVITRAC® B frequency inverters and MOVIDRIVE® B drive inverters as generators. Using an integrated temperature sensor, the resistor can be protected without external monitoring.
ND line chokes	ND series line chokes increase the overvoltage protection of inverters. This is an important characteristic in rough industrial power supply systems, especially if the inverter is installed near a supply transformer.
NF line filters	The NF line filter series is available for EMC-compliant installation according to EN 61800-3. They suppress interference emission on the line side of inverters. These line filters ensure that limit value class C1 is maintained on the supply end.
HD output chokes	HD series output chokes suppress interference emitted from unshielded motor cables. They enable the motor to meet limit value class C1 requirements in accordance with EN 61800-3 in EMC-compliant installations. Output chokes provide an alternative to shielded motor cables in EMC-compliant installations.
HF output filters	HF series output filters are sine filters that smooth out the output voltage of inverters. Output filters are used for group drives to suppress discharge currents in motor cables and for long motor cables to prevent voltage peaks.

MOVIAXIS® multi-axis servo inverters



Features

- Multi-axis servo inverters for highly dynamic applications up to 250 A motor current
- Power supply modules and regenerative power supply modules up to 187 kW
- DC link power supply for DC 24 V
- Capacitor and buffer modules
- Connection of all common motor and distance encoders
- Fieldbus interfaces, fieldbus gateways and clock-synchronized interfaces
- Scaled motion and logic controller directly at the axis system, speed control, positioning, motion control and kinematics
- Wide range of accessories: Cables, braking resistors, line filters, line chokes, brake control units

Power supply module type

Line connection V	3x AC 380 – 500
Nominal power kW	10, 25, 50, 75 kW at 250% for 1 s

Block-shaped power supply and regenerative power supply module

Line connection V	3x AC 380 – 500
Nominal power kW	50, 75 kW at 250% for 1 s

Sinusoidal power supply and regenerative power supply module

Line connection V	3x AC 380 – 480
Nominal power kW	50, 75 kW at 200% for 1 s

6.1 Control cabinet installation

MOVIAXIS® multi-axis servo inverters

DC link power supply unit

Supply	Directly from DC link
Nominal power	3x 10 A, limited to 600 W total power

Axis modules

Output current in A at 8 kHz	2, 4, 8, 12, 16, 24, 32, 48, 64, 100 at 250% for 1 s
Communication interfaces	PROFIBUS, EtherCAT®
Encoder interfaces motor encoder	HIPERFACE®, resolver, TTL, sin/cos, Endat 2.1
Encoder interfaces distance encoder	HIPERFACE®, TTL, HTL, sin/cos, Endat 2.1, SSI
safetyDRIVE functional safety	<ul style="list-style-type: none"> – MXA81: STO (Safe Torque Off), up to PL d according to EN ISO 13849-1 – MXA82: STO (Safe Torque Off), up to PL e according to EN ISO 13849-1 – MOVISAFE® UCS..B safety module option: Drive safety functions (SLS, SDI, SLP, etc.) according to EN 61800-5-2 – Safety-related BST brake module option: SBC (Safe Brake Control) safety function up to PL d according to EN ISO 13849-1

Master module

Communication module	DeviceNet™, PROFIBUS, PROFINET, EtherNet/IP™, Modbus TCP
Data management	Via memory card, automatic data set download when replacing the axis module
Integrated motion controller	Programmable in IEC 61131, parameterizable functionalities

Accessories and options for MOVIAXIS®

Encoder card and distance encoder card XGH11A	<ul style="list-style-type: none"> – Multi-encoder card for motor encoder and distance encoder HIPERFACE®, Endat 2.1, sin/cos – Incremental encoder simulation – ± 10 V analog input – DC 24 V supply
Encoder card and distance encoder card XGS11A	<ul style="list-style-type: none"> – Like XGH11A, additional for SSI encoders
Input/output card XIA11A	<ul style="list-style-type: none"> – 4 DI, 4 DO – 2 AI, 2 AO, 12-bit resolution – DC 24 V supply
Input/output card XIO11A	<ul style="list-style-type: none"> – 8 DI, 8 DO – DC 24 V supply
Communication interface XFP11A	PROFIBUS IO fieldbus interface, up to 12 MBaud
Communication interface XFE24A	Fieldbus interface for connection to EtherCAT® networks
Communication interface XSE24A	System bus option card for expansion to EtherCAT®-compatible system bus SBus ^{PLUS}
MOVI-PLC® controller – DHE41B – DHF41B – DHR41B – UHX71B	<ul style="list-style-type: none"> – MOVI-PLC® advanced, Ethernet interface – MOVI-PLC® advanced, Ethernet / PROFIBUS / DeviceNet™ interface – MOVI-PLC® advanced, Ethernet / PROFINET / Modbus TCP / EtherNet/IP™ interface <p>Compact controller:</p> <ul style="list-style-type: none"> – MOVI-PLC® power: IEC-61131-3 programmable motion and logic controller or – CCU power: parameterizable application controller
MOVITOOLS® MotionStudio engineering software	The MOVITOOLS® MotionStudio program package allows you to conveniently start up, configure and diagnose the MOVIAXIS® multi-axis system.
BW braking resistors	BW series braking resistors are available for the regenerative operation of the MOVIAXIS® multi-axis system. Using an integrated temperature sensor, the resistor can be protected without external monitoring.
ND line chokes	ND series line chokes increase the overvoltage protection of the MOVIAXIS® multi-axis system. This is an important characteristic in rough industrial power supply systems, especially if the inverter is installed near a supply transformer.
NF line filters	The NF line filter series is available for EMC-compliant installation according to EN 61800-3. They suppress interference emission on the line side of inverters. These line filters ensure that limit value class C1 is maintained on the supply end.

6.1 Control cabinet installation

MOVIDRIVE® MDR regenerative power supply units 15 kW – 160 kW



MOVIDRIVE® MDR



<p>Can be used with product series</p>	<ul style="list-style-type: none"> – MOVIDRIVE® B: 0.55 – 315 kW – MOVITRAC® B: 5.5 – 75 kW
<p>Features</p>	<p>Energy balance</p> <p>Braking energy from the load cycle is no longer converted into heat energy but is fed back into the grid.</p> <p>Energy recovery is particularly interesting for applications with a high energy potential of lowering/ deceleration movements of the load cycle, such as gantry cranes, storage/retrieval systems or lifting/lowering applications.</p>
<p>Regenerative power supply: For central energy supply and recovery</p>	<ul style="list-style-type: none"> – Used for central energy supply and recovery to supply the connected inverters with energy – Several inverters are connected in a DC link system – Energy is exchanged between the drive axes and the regenerative power supply unit, which feeds back excess braking energy into the power supply system
<p>Regenerative power supply: Function as a brake module (only MDR60A0150)</p>	<ul style="list-style-type: none"> – Using the regenerative power supply unit as brake module means the connected inverters are not supplied with energy but only the braking energy is fed back into the power supply system – The DC link is supplied via the integrated input rectifier of the inverter – Braking energy released during the application is fed back into the power supply system – The regenerative power supply unit is selected based on the braking energy released during the application, inverters are selected based on the motor load → cost-optimized overall system – Example of a product combination: MOVIDRIVE® B application inverter 30 kW with MOVIDRIVE® MDR regenerative power supply 15 kW
<p>Advantages</p>	<ul style="list-style-type: none"> – Reduced overall energy consumption – Reduced CO₂ emissions – Reduced energy costs – Cost-efficient installation – No investment in braking resistors – No braking resistors need to be installed outside the control cabinet – No heating of the environment or of the control cabinet through braking resistors – Saves expenditure for control cabinet ventilation – Saves control cabinet space

Technical data

MOVIDRIVE® type MDR..	Connection voltage	Power range kW	Line current I_N A	Overload capacity
MDR60A0150-503-00 Size 2	3x AC 380 V – 500 V	15	– 15 as centralized supply and regenerative power supply unit – 22 as brake module	– 150% for 60 s as centralized supply and regenerative power supply unit – 37 kW for 50 s as brake module peak braking power
MDR60A0370-503-00 Size 3		37	66	150% for 60 s
MDR60A0750-503-00 Size 4		75	117	150% for 60 s
MDR60A1320-503-00 Size 6		132 – 160	260 (at 160 kW)	150% for 60 s Max. continuous power, 125%

6.1 Control cabinet installation

Regenerative power supply for MOVIDRIVE® B and MOVITRAC® B

Regenerative power supply: Function as a brake module

- Braking energy released during the application is fed back into the power supply system
- The regenerative power supply unit is selected based on the braking energy
- Drive inverters are selected based on the motor load
- The DC link is supplied via the integrated input rectifier on the drive axis

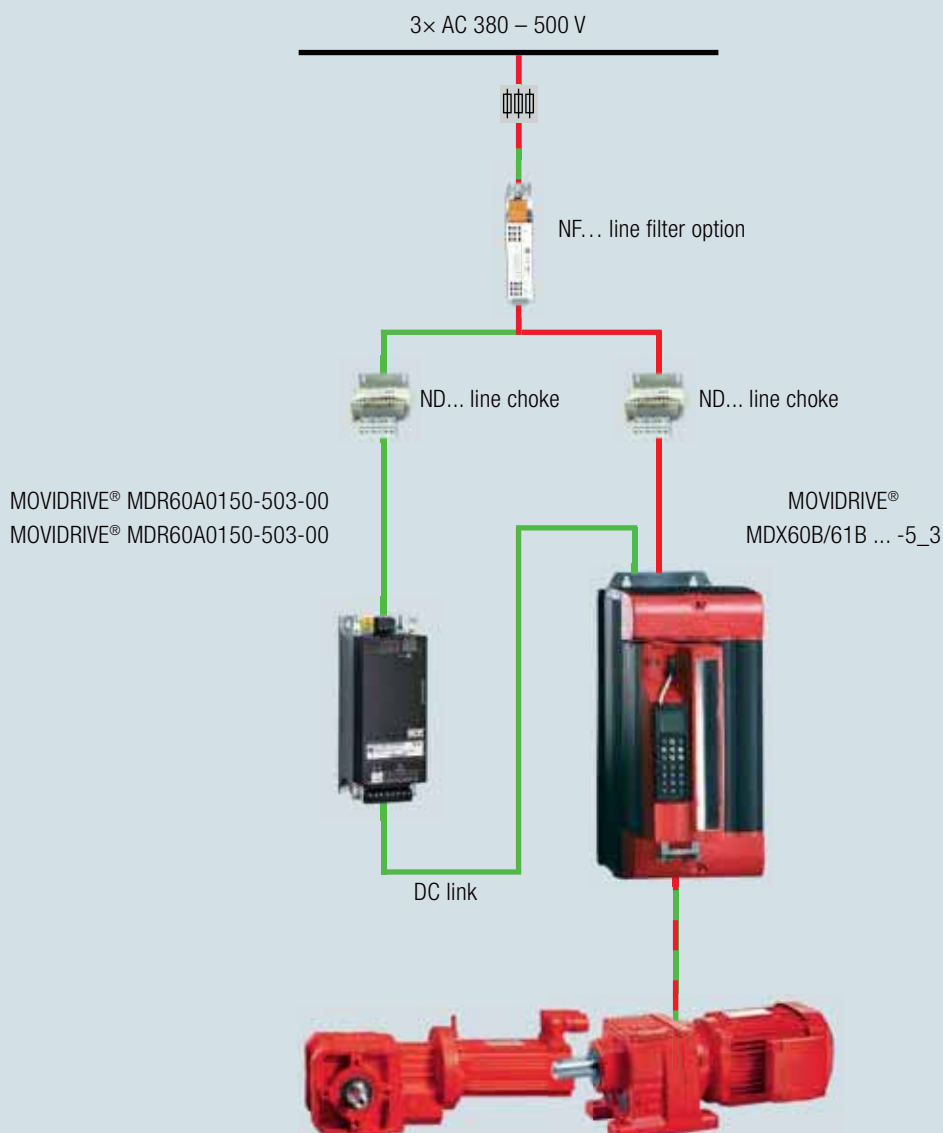

- Reduced overall energy consumption
- Reduced CO₂ emissions
- Reduced energy costs
- Cost-efficient installation
- No investments in braking resistors
- No braking resistors need to be installed outside the control cabinet
- No heating of the environment or of the control cabinet through braking resistors
- Saves expenditure for control cabinet ventilation
- Saves control cabinet space

MOVIDRIVE® MDR regenerative power supply

Regenerative power supply: Function as a centralized supply and regenerative power supply unit

- Braking energy released during the application is fed back into the power supply system
- The regenerative power supply unit is selected based on the motor load
- The DC link is supplied via regenerative power supply
- Less installation work by connecting several drive axes to a central regenerative power supply
- Central exchange of energy between the drive axes

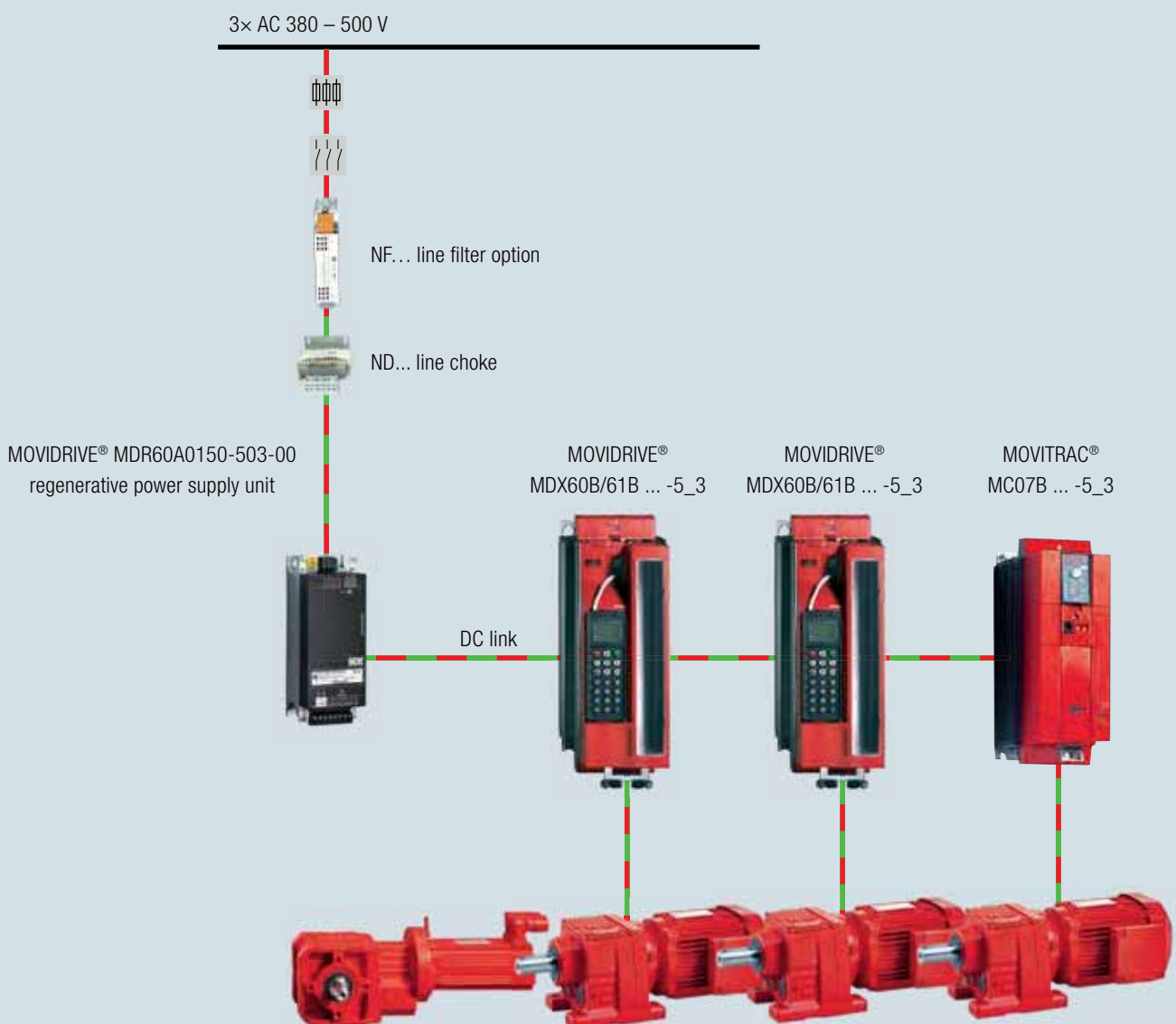

- Reduced overall energy consumption
- Reduced CO₂ emissions
- Reduced energy costs
- Cost-efficient installation
- No investments in braking resistors
- No braking resistors need to be installed outside the control cabinet
- No heating of the environment or of the control cabinet through braking resistors
- Saves expenditure for control cabinet ventilation
- Saves control cabinet space

6.1 Control cabinet installation

MOVIDRIVE® MDR regenerative power supply units and motor inverters 160 kW – 315 kW



MOVIDRIVE® MDR61B regenerative power supply



Features	<ul style="list-style-type: none"> – Energy-efficient and optimized overall concept: MOVIDRIVE® B product series extended by regenerative power supply units and corresponding motor inverters in the power range from 160 to 315 kW – Particularly interesting for applications with potential energy, such as in hoists, cranes and gantries, or in trolleys with high kinetic energy produced through electrical braking 	
Functions	<ul style="list-style-type: none"> – Used as central regenerative power supply for connected standard inverters or motor inverters – Energy is fed back into the supply system when the application is operating as a generator, e.g. during electrical braking – Braking energy is no longer converted into heat but is fed back into the supply system for further use 	
Advantages	<ul style="list-style-type: none"> – Significant reduction of the overall energy consumption/of CO₂ emissions/of energy costs – No braking resistors are required <ul style="list-style-type: none"> - No investment costs for braking resistors - No installation effort for external braking resistors - No heating up of the environment through braking resistors – Sinusoidal line current = controlled energy recovery – With coated printed-circuit boards as standard for demanding ambient conditions – Simple installation and wiring: integrated PWM filter/integrated choke/integrated and automatic DC link precharge/integrated line contactor – Modular power section, which means not the entire unit needs to be replaced in the event of service – EMC limit value class C3 (EN 61800-3) with the standard unit <ul style="list-style-type: none"> - On supply system end: without any measures → no external line filter necessary - On motor end: with shielded motor cables and output choke 	
Type designation	MDR61B1600-503-00/L	MDR61B2500-503-00/L
Connection voltage	3x AC 380 V – 500 V	
Nominal power kW	160	250
Line current/nominal motor current I_N A	250	400
Maximum continuous power	125% I _N	
Overload capacity	150% I _N for 60 s	
External accessories for control cabinet installation	<ul style="list-style-type: none"> – Mounting base – Air duct – Connection kit – Touchguard (IP20 kit) – DC link coupling 	



MOVIDRIVE® MDX62B motor inverters



Features	<ul style="list-style-type: none"> – Energy-efficient and optimized overall concept: MOVIDRIVE® B product series extended by regenerative power supply units and corresponding motor inverters in the power range from 160 to 315 kW – Particularly interesting for applications with potential energy, such as in hoists, cranes and gantries, or in trolleys with high kinetic energy produced through electrical braking 		
Functions	<ul style="list-style-type: none"> – MOVIDRIVE® B standard inverter without input stage for connection to the MOVIDRIVE® MDR61B regenerative power supply 		
Advantages	<ul style="list-style-type: none"> – Cost-optimized MOVIDRIVE® B standard inverter without input subassemblies – Simple installation – DC link connection via conductor rail – All MOVIDRIVE® B option cards can be used 		
Type designation	MDX62B1600-503-4-0T/L	MDX62B2000-503-4-0T/L	MDX62B2500-503-2-0T/L
Connection voltage	Connection to MDR61B regenerative power supply unit		
Nominal power kW	160	200	250
Line current/nominal motor current I_N A	300	380	470
Maximum continuous power	125% I_N		
Overload capacity	150% I_N for 60 s		
Internal options	Utilization of all MOVIDRIVE® B option cards for connection to fieldbus systems and evaluation of motor encoders or distance encoders (see MOVIDRIVE® B options)		
External accessories for control cabinet installation	<ul style="list-style-type: none"> – Mounting base – Air duct – Connection kit – Touchguard (IP20 kit) – DC link adapter – DC link coupling 		

6.1 Control cabinet installation

effiDRIVE® – Energy efficiency in the control cabinet

 <p>The perfect drive solution for applications from simple speed control to dynamic positioning</p>	Process adaptation	Energy-saving function	DC link coupling	Regenerative power supply	Thermally controlled fans
 <p>MOVITRAC® LTE-B+ – Compact range of functions for simple applications</p>	✓	✓			✓
 <p>MOVITRAC® LTP-B – Adjusted range of functions for simple applications</p>	✓	✓	✓		✓
 <p>MOVITRAC® B – Compact design with complete range of functions – Cost-efficient choice for standard tasks</p>	✓	✓	✓	✓	✓
 <p>MOVIDRIVE® B – High basic functionality with wide range of options – Cost-effective choice for complex systems</p>	✓	✓	✓	✓	✓

Process adaptation

- Almost every process can be adapted to the actual demand thanks to infinitely variable speed and torque control, which makes the process more energy efficient. Depending on the application, energy savings of up to 70% can be achieved.
 - More energy-saving potential can be tapped in applications with periodic acceleration and deceleration through energy-efficient motion sequences. Maximum acceleration, speed and braking deceleration are not always necessary.
-

Energy-saving function

- The energy-saving function of MOVITRAC® LTE-B+ and LTP-B, MOVITRAC® B as well as of MOVIDRIVE® B offers advantages when the application has to be operated in the part-load range and dynamic properties are not a main requirement when load changes occur.
 - The dynamic adjustment of the magnetization current enables the motor to be operated with optimum efficiency in every operating point. Energy consumption is reduced by up to 30% depending on the application.
 - The energy-saving function ensures optimum efficiency of the drive especially in conjunction with an energy-efficient motor.
-

DC link coupling

- By connecting the DC links of several inverters, regenerative energy of one drive can be used directly as motor energy for another drive.
 - This measure can reduce energy consumption from the supply system if the drive sequences are segmented and suitable travel profiles have been selected.
 - MOVI-PLC®: In storage and retrieval systems, the decentralized controller allows for controlling the travel profile in an intelligent manner and in this way achieves optimum energy coupling.
-

Regenerative power supply

- A regenerative power supply unit feeds back the regenerative energy of a drive into the supply system.
 - The released braking energy is not dissipated via braking resistors but is fed back into the supply system, which saves energy.
 - This is especially effective in hoists and storage and retrieval units.
-

Thermally controlled fans

- The fans are switched on only when actual waste heat is generated. Not only does this lower energy consumption, it also increases the service life of the fan.
-

6.1 Control cabinet installation

effiDRIVE® – Energy efficiency in servo applications



Features

The crucial part of energy-efficient operation of servo drive technology is the detailed planning and fulfillment of process and efficiency requirements. With the energy efficiency concept effiDRIVE® for servo applications, SEW-EURODRIVE offers comprehensive consulting during the planning of new plants and the modernization of existing systems. With our great expertise regarding drive technology and the industry, we focus on efficiency already during the first steps of selecting the used technology and products in order to optimize the energy consumption. But it is not sufficient to only combine energy-efficient components. Only looking at the application in its entirety allows for the maximum energy efficiency.

Energy-efficient components

Sine-shaped regenerative power supply modules MXR80A	<ul style="list-style-type: none"> – In regenerative operating states, the braking energy is fed back into the supply system – Energy supply and energy recovery are sinusoidal with $\cos \phi = 1$ – Almost complete avoidance of supply harmonics – No interference of sensitive electronic devices in direct vicinity – Determination of energy flow, detailed diagnostic information – Controlled DC link voltage independent of link voltage
Block-shaped regenerative power supply modules MXR81A	<ul style="list-style-type: none"> – In regenerative operating states, the braking energy is fed back into the supply system – Inexpensive alternative to sinusoidal regenerative power supply if the supply system conditions are stable – Automatic deactivation of the recovery during motoring operation – Emergency braking resistor can be connected
Memory module MXC80A	<ul style="list-style-type: none"> – DC link energy is absorbed or supplied with up to 50 kW – Up to 1000 Ws can be stored in the module – The module is charged actively via charging connection – With adequate project planning, the braking energy can be completely recycled for the next travel task – There is no need for braking resistors – Especially suited for cycles with small drives
Compact power supply module MXP81A	<ul style="list-style-type: none"> – Combination of 10 kW power supply module and 250 Ws capacitor module – Especially cost-effective and space-saving with small systems – Size-optimized braking resistor is already integrated in the module

6.2 Wall mounting

MOVI4R-U® basic inverters



MOVI4R-U® in IP54

Features	<ul style="list-style-type: none"> – Optimum solution to fulfill the basic requirements in drive technology: simple speed control of asynchronous motors – Intuitive operating concept for short startup times and simple handling – High degree of protection IP54 – Modular design for quick device replacement – Fast and simple exchange of the power section in service cases – Guaranteed integration into recycling systems 	
Line connection	Power range kW	
1-phase / 220 – 240 V	0.25 – 0.55	
3-phase / 220 – 240 V	0.25 – 1.5 (NEW: Extended power range)	
3-phase / 380 – 500 V	0.25 – 4.0 (NEW: Extended power range)	
Features	<ul style="list-style-type: none"> – Frequency inverter with V/f control – Control plate with control knob as combination of adjusting knob and push button – Control and setpoint selection: <ul style="list-style-type: none"> - with digital inputs and fixed setpoints - setpoint selection with analog input - manual mode with control plate <p>MOVI4R-U® is based on a sustainable product concept that allows for re-integration into material and raw material cycles. For more information, refer to www.sew-eurodrive.com</p>	
Options	NF003.. and NF008..	HD..
	Line filter combined with a main switch <ul style="list-style-type: none"> – Facilitates EMC-compliant installation – Simply switch off the inverter individually during maintenance work 	Output filter <ul style="list-style-type: none"> – to suppress magnetization noises at the motor – to improve cable losses and for long motor cables

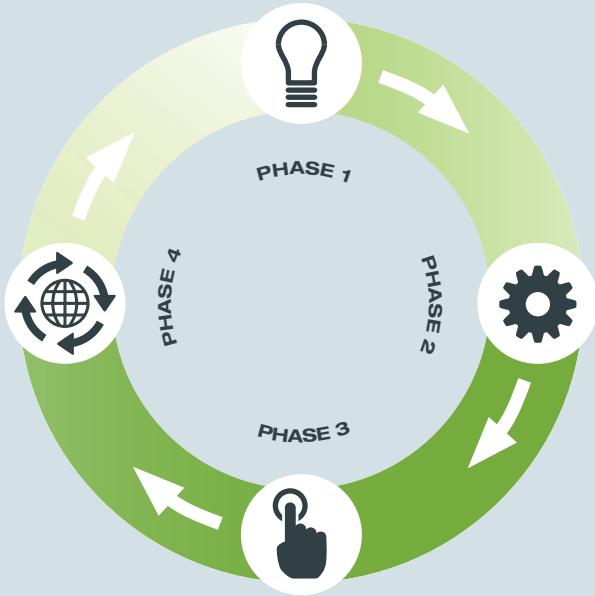

Sustainable product life cycle of MOVI4R-U® for optimum conservation of resources

<p>Phase 1 Development</p>	<ul style="list-style-type: none"> - Choice of environmentally friendly materials - Low material and raw material intensity - Reduced material diversity, simple separability
<p>Phase 2 Manufacturing</p>	<ul style="list-style-type: none"> - Resource-efficient production and logistics concepts - Use of renewable energies - Low transport intensity thanks to local production - Environment-friendly manufacturing processes
<p>Phase 3 Utilization</p>	<ul style="list-style-type: none"> - High energy efficiency of the operating phase - Optimized product life: durable, maintenance-friendly, expandable - Option for technical upgrade (without replacing the entire device) - effiDRIVE® energy-saving advice for support
<p>Phase 4 Re-integration</p>	<ul style="list-style-type: none"> - Design that is suitable for recycling - Re-integration and recycling of components in material and raw material cycles - Environmentally sound waste disposal

Recycling processes



Today's products are tomorrow's raw materials. We are happy to arrange a homogenous separation and correct re-integration of the materials used in MOVI4R-U® in the material cycles – feel free to contact us!

The basic inverter has been scientifically tested in a life-cycle assessment study carried out by the Institute for Industrial Ecology of the Pforzheim University.

MOVI4R-U® achieved first successes and won the "Nachhaltige Produktion Award 2014" (sustainable production award) at the "Industrial Green-Tech-Conference" at HANNOVER MESSE 2014.

6.2 Wall mounting

MOVITRAC® LTE-B+ basic inverters



MOVITRAC® LTE-B+ in IP66

**Line connection / power range
kW**

- 115 V / 1-phase: 0.37 – 1.1
- 230 V / 1-phase: 0.37 – 4.0
- 230 V / 3-phase: 1.5 – 18.5 **NEW:** Extended power range
- 400 V / 3-phase: 0.75 – 37.0 **NEW:** Extended power range

➔ More information on MOVITRAC® LTE-B+ in IP20: page 244

MOVITRAC® LTP-B standard inverters



MOVITRAC® LTP-B in IP55/IP66

**Line connection / power range
kW**

- 230 V / 1-phase: 0.75 – 2.2
- 230 V / 3-phase: 0.75 – 75
- 400 V / 3-phase: 0.75 – 160
- 575 V / 3-phase: 0.75 – 110

Features

- Flexible, simple and safe
- Standard design in degree of protection IP55/NEMA 12k and IP66/NEMA 4X housing for wall mounting
- Optionally also available in degree of protection IP20/NEMA 1 for control cabinet installation

MOVITRAC® LTP-B standard inverters

Features	<ul style="list-style-type: none"> – NEW: Full text display for devices with high degree of protection – Integrated keypad – PI controller – KTY, motor protection function PT1000 – Emergency mode/fire mode – Fieldbus connection via SEW system bus/CANopen/Modbus RTU in the basic device or via option card / SEW gateway/MOVI-PLC® – Preconfigured for corresponding DR.. motor – Energy-saving function – DC link connection – Extra quiet pulsed voltage supply up to 16 kHz – Overload capacity up to 175% – V/f and VFC speed and torque vector control – Operation of synchronous motors with LSPM technology (Line Start Permanent Magnet Motor) – Safe Torque Off (STO) according to EN ISO 13849-1 PL d – Approved in accordance with UL508
Options	
LT BG OLED A	Remote full text keypad in IP54 in control cabinet door
LT BG-C	Remote keypad in IP54 in control cabinet door
LT BP-C	Bluetooth® parameter module (parameter setting, data backup)
USB11A	Interface adapter for connection to a PC via USB interface
LT OP..	Cable sets for direct fieldbus connection via SEW system bus
DFx.. /UOH..	Gateways for connecting fieldbuses in the control cabinet
LT FP / LT FD / LT FB / LT FE	Option cards for direct connection of single inverters to fieldbuses
LT OB EN..	Option cards for connection of HTL and TTL encoders
LT OB 3ROUT A	Relay option card
LT OB IO A	I/O expansion option card
BW..	Braking resistors
ND LT..	Line chokes
NF LT..	Line filters
HD LT..	Output chokes

6.3 Decentralized installation: motor starters

NEW: MOVIFIT® compact basic motor starters



Features

Minimum effort – maximum effect

- FieldPower® contact block* for energy distribution with modern and reliable connector technology
- Simple connection and wiring technology
- Systematic integration of energy distribution components in the housing of the drive unit
- Consistent use of standard plug connectors for control and motor connection
- Extremely short assembly and installation times
- In connection with AS-Interface, two sensors can be connected to the unit in addition to the drive function for direct communication with the system controller (everything included)

Technical data

Function	Reversing	Duo	Reversing	Duo
Control	AS-Interface		Binary control signals	
Max. motor power kW	2.2 and 4	2x 2.2	2.2 and 4	2x 2.2
Connection voltage V_{AC}	AC 3x 380 -10% – 480 +10%			
Line frequency Hz	50 / 60			
Line connection	FieldPower® contact block			
Line protection	External			
Ambient temperature	-20 °C to +40 °C			
Degree of protection	IP55			
Service interface	For connecting the keypad or the interface for MOVITOOLS® MotionStudio			
Connection control	M12 plug connector 1x male / 2x female		M12 plug connector 2x male / 1x female	
Inputs and outputs	2 digital inputs for connecting external sensors		<ul style="list-style-type: none"> – 3 control inputs – 1 digital output – DC 24 V output 	
Brake control	<ul style="list-style-type: none"> – Supply via motor connection – Brake voltage = line voltage – BG rectifier in motor terminal box 			
Option	Built-in main switch: simply switch off the inverter individually during maintenance work			
Dimensions L x W x H mm	255 x 150 x 159			

MOVI-SWITCH® motor starters



Features

- Gearmotor with switching and protection function integrated in the motor terminal box
 - 2-, 4- and 6-pole
 - Power range 0.09 to 3.0 kW
-

- ➔ **More information on**
- **MOVI-SWITCH®: page 238**
 - **Fieldbus interfaces, field distributors, cable systems: page 220**

6.3 Decentralized installation: motor starters

MOVIFIT® SC motor starters



Features	<ul style="list-style-type: none"> – Electronic (contactless) motor starter with one or two directions of rotation – Parameterizable soft startup time – Integrated brake management – Increased safety through switching of 3 phases – Integrated power distribution with line protection up to 6 mm² – Optional maintenance switch – CAN/SBus interface for external components – Free programming according to IEC 61131 – Integrated parameter memory – Comprehensive diagnostics via LEDs – Expanded parameterization and diagnostics via MOVITOOLS® MotionStudio or fieldbus – Robust aluminum housing – Degree of protection IP65 (optional IP69K) – Approval: CE, UL and CCC – Optional: Hygienic^{PLUS} design, degree of protection IP69K among others
Technical data	<p>Power range</p> <ul style="list-style-type: none"> – When connecting 2 motors (dual-motor starter) → one direction of rotation: 0.37 kW – 1.5 kW each – When connecting 1 motor (reversing starter) → two directions of rotation: 0.37 kW – 3.0 kW each <p>Voltage range 3x AC 380 V – 500 V / 50 Hz to 60 Hz</p> <p>Digital inputs/outputs</p> <ul style="list-style-type: none"> – 6 DI + 2 DI/O with function level Classic – 12 DI + 4 DI/O with function level Classic and PROFINET fieldbus – 12 DI + 4 DI/O with function level Technology
Communication	PROFIBUS, PROFINET, DeviceNet™, EtherNet/IP™ and Modbus/TCP, PROFINET interface SCRJ/POF
Connection variants	Motor starter consists of EBOX = electronics unit and ABOX = connection box: <ul style="list-style-type: none"> – MOVIFIT® standard connection box via cable glands – MOVIFIT® hybrid connection box: with variable connector configuration

MOVIFIT® function level

indicates the functional scope of the software assigned to the MOVIFIT® units in terms of:

- Operation
- Local system control
- Diagnostics

Classic	Technology
Simple functions	Free programming (MOVI-PLC®/MOVITOOLS® MotionStudio)
<ul style="list-style-type: none"> – “Easy mode”: Easy startup via DIP switches possible – Standardized drive functions – Control as fieldbus gateway – Extended configuration and diagnostics options via gateway configurator 	<ul style="list-style-type: none"> – Programming in accordance with IEC 61131 (e. g. in LD, FBD, STL, ST, SFC) – MOVITOOLS® MotionStudio with PLC Editor, Application Builder, etc. – Multi-level library concept (application and program modules of the MOVI-PLC® controller series) – Decentralized processing of digital inputs and outputs in the software

6.4 Decentralized installation: inverters

NEW: MOVIFIT® compact basic inverters



Simple user interfaces – short installation times

FieldPower® contact block* for energy distribution with modern and reliable connector technology

- Simple connection and wiring technology
- Systematic integration of energy distribution components in the housing of the drive unit
- Consistent use of standard plug connectors for control and motor connection
- Extremely short assembly and installation times
- In connection with AS-Interface, two sensors can be connected to the unit in addition to the drive function for direct communication with the system controller (everything included)

Function	Frequency inverter with parameterizable ramps and up to 4 fixed speeds					
Control	AS-Interface			Binary control signals		
Max. motor power kW	0.75	1.1	1.5	0.75	1.1	1.5
Connection voltage V_{AC}	AC 3x 380 -10% – 480 +10%					
Line frequency Hz	50 / 60					
Line connection	FieldPower® contact block					
Line protection	External					
Ambient temperature	-20 °C to +40 °C					
Degree of protection	IP55					
Service interface	For connecting the keypad or the interface for MOVITOOLS® MotionStudio					
Connection control	M12 plug connector 1x male / 2x female			M12 plug connector 2x male / 1x female		
Inputs and outputs	2 digital inputs for connecting external sensors			<ul style="list-style-type: none"> – 4 control inputs – 1 digital output – DC 24 V output 		
Brake control	<ul style="list-style-type: none"> – Switched power output at the controller – Brake voltage = line voltage – BG rectifier in motor terminal box 					
Options	<ul style="list-style-type: none"> – Built-in EMC filter: facilitates EMC-compliant installation – Built-in main switch: simply switch off the inverter individually during maintenance work 					
Dimensions L × W × H mm	255 x 150 x 159					

MOVIMOT® standard inverters



Features	The standard inverter for direct mounting to the motor or mounting close to the motor
Power range kW	<ul style="list-style-type: none"> – 3x 380 – 500 V: 0.37 – 4.0 – 3x 200 – 240 V: 0.7 – 2.2

- **More information on**
- **MOVIMOT®: page 216**
 - **Fieldbus interfaces, field distributors, cable systems: page 220**

6.4 Decentralized installation: inverters

MOVIFIT® MC distributors for MOVIMOT®



	MOVIFIT® MC Classic distributors: for MOVIMOT®	MOVIFIT® MC Technology controllers: for MOVIMOT®
Features	<ul style="list-style-type: none"> – Power, communication and function distributor for MOVIMOT® – Up to 3 MOVIMOT® drives can be connected via hybrid cable – Integrated power distribution with line protection up to 6 mm² – Optional maintenance switch – Optional incremental encoder connection – Comprehensive safety functionality – All common bus systems are available – Integrated digital inputs and outputs – Integrated parameter memory – Comprehensive diagnostics via LEDs – Expanded parameterization and diagnostics via MOVITOOLS® MotionStudio or fieldbus – Plug-in interfaces for power, motor (power rating) and I/Os – Robust aluminum housing – Degree of protection IP65 – Approval: CE, UL and C 	
Technical data	<ul style="list-style-type: none"> – Power range MOVIMOT® 0.37 kW to 4 kW in two sizes – Power range MOVIFIT® MC 3x 380 V to 500 V / 50 Hz to 60 Hz – 12 DI + 4 DIO (DI = digital input, DIO = digital input/output) 	

<p>Function level</p>	<p>indicates the functional scope of the software assigned to the MOVIFIT® units in terms of:</p> <ul style="list-style-type: none"> – Software functionality – Processing of digital inputs and outputs – Local system control – Startup, operation, and diagnostics <table border="1" data-bbox="576 544 1474 1290"> <tr> <td data-bbox="576 544 1023 663"> <p>MOVIFIT® MC Classic distributors Simple and standardized functions</p> </td> <td data-bbox="1023 544 1474 663"> <p>MOVIFIT® MC Technology controllers Parameterizable application modules and free programming</p> </td> </tr> <tr> <td data-bbox="576 663 1023 1290"> <ul style="list-style-type: none"> – “Easy mode”: easy startup using DIP switches possible – Standardized drive functions – Control as fieldbus gateway – Extended configuration and diagnostics options via gateway configurator </td> <td data-bbox="1023 663 1474 1290"> <p>Parameterizable application modules – standardized application functions</p> <ul style="list-style-type: none"> – Standardized functions – Control and diagnostics via fieldbus – Parameterization instead of programming – Startup and diagnostics using MOVITOOLS® MotionStudio <p>Free programming (MOVI-PLC® / MOVITOOLS® MotionStudio)</p> <ul style="list-style-type: none"> – Programming in accordance with IEC 61131 (e.g. in LD, FBD, STL, ST, SFC) – MOVITOOLS® MotionStudio with PLC Editor, Application Builder, etc. – Multi-level library concept (application and program modules of the MOVI-PLC® controller series) – PLCopen-certified motion blocks </td> </tr> </table>	<p>MOVIFIT® MC Classic distributors Simple and standardized functions</p>	<p>MOVIFIT® MC Technology controllers Parameterizable application modules and free programming</p>	<ul style="list-style-type: none"> – “Easy mode”: easy startup using DIP switches possible – Standardized drive functions – Control as fieldbus gateway – Extended configuration and diagnostics options via gateway configurator 	<p>Parameterizable application modules – standardized application functions</p> <ul style="list-style-type: none"> – Standardized functions – Control and diagnostics via fieldbus – Parameterization instead of programming – Startup and diagnostics using MOVITOOLS® MotionStudio <p>Free programming (MOVI-PLC® / MOVITOOLS® MotionStudio)</p> <ul style="list-style-type: none"> – Programming in accordance with IEC 61131 (e.g. in LD, FBD, STL, ST, SFC) – MOVITOOLS® MotionStudio with PLC Editor, Application Builder, etc. – Multi-level library concept (application and program modules of the MOVI-PLC® controller series) – PLCopen-certified motion blocks
<p>MOVIFIT® MC Classic distributors Simple and standardized functions</p>	<p>MOVIFIT® MC Technology controllers Parameterizable application modules and free programming</p>				
<ul style="list-style-type: none"> – “Easy mode”: easy startup using DIP switches possible – Standardized drive functions – Control as fieldbus gateway – Extended configuration and diagnostics options via gateway configurator 	<p>Parameterizable application modules – standardized application functions</p> <ul style="list-style-type: none"> – Standardized functions – Control and diagnostics via fieldbus – Parameterization instead of programming – Startup and diagnostics using MOVITOOLS® MotionStudio <p>Free programming (MOVI-PLC® / MOVITOOLS® MotionStudio)</p> <ul style="list-style-type: none"> – Programming in accordance with IEC 61131 (e.g. in LD, FBD, STL, ST, SFC) – MOVITOOLS® MotionStudio with PLC Editor, Application Builder, etc. – Multi-level library concept (application and program modules of the MOVI-PLC® controller series) – PLCopen-certified motion blocks 				
<p>safetyDRIVE functional safety</p>	<p>Safety functions integrated in the MOVIMOT® inverter in accordance with IEC 61800-5-2:</p> <ul style="list-style-type: none"> – Safe disconnection (STO) – Safe stopping SS1 (c) – Approval in accordance with: <ul style="list-style-type: none"> - Performance level d according to EN ISO 13849-1 - SIL 2 according to IEC 61800-5-2 <p>Safety options S11 and S12</p> <ul style="list-style-type: none"> – PROFIsafe connection or independent operation (different numbers of safe inputs and outputs) 				

6.4 Decentralized installation: inverters

MOVIFIT® FC inverters



	MOVIFIT® FC Classic standard inverters	MOVIFIT® FC Technology application inverters
Features	<ul style="list-style-type: none"> – Decentralized frequency inverter with a wide range of functions – Constant speed control, synchronized motion, simple lifting axes – Integrated T-distributor for supply and control voltage up to 6 mm² – Integrated energy efficient brake management for various brake voltages – Optional internal (integrated in ABOX) or external braking resistor – Optional maintenance switch – Optional incremental encoder connection – All common bus systems are available – Integrated parameter memory – Comprehensive diagnostics via LEDs – Expanded parameterization and diagnostics via MOVITOOLS® MotionStudio or fieldbus – Plug-in interfaces for power, motor (power rating) and I/Os – Robust aluminum housing – Degree of protection IP65 (optional IP69K) – General approvals: CE, UL and C 	
Technical data	<ul style="list-style-type: none"> – Power range from 0.37 kW to 4 kW <ul style="list-style-type: none"> - Size 1: 0.37 kW to 1.5 kW - Size 2: 2.2 kW to 4.0 kW – Voltage range 3x 380 V to 500 V / 50 Hz to 60 Hz – 12 DI + 4 DI/O with function level Classic and PROFINET fieldbus – 6 DI + 2 DI/O with function level Classic – 12 DI + 4 DIO (DI = digital input, DIO = digital input/output) with function level Technology 	

<p>Function level</p>	<p>indicates the functional scope of the software assigned to the MOVIFIT® units in terms of:</p> <ul style="list-style-type: none"> – Software functionality – Processing of digital inputs and outputs – Local system control – Startup, operation, and diagnostics <table border="1" style="width: 100%; border-collapse: collapse;"> <tr> <td data-bbox="576 544 1023 831"> <p>MOVIFIT® FC Classic standard inverters Simple and standardized functions</p> </td> <td data-bbox="1023 544 1458 831"> <p>MOVIFIT® FC Technology application inverters Parameterizable application modules:</p> <ul style="list-style-type: none"> – Standardized functions – Control and diagnostics via fieldbus – Setting parameters instead of programming – Startup and diagnostics using MOVITOOLS® MotionStudio </td> </tr> <tr> <td data-bbox="576 831 1023 1182"> <ul style="list-style-type: none"> – “Easy mode”: easy startup using DIP switches possible – Standardized drive functions – Control as fieldbus gateway – Extended configuration and diagnostics options via gateway configurator </td> <td data-bbox="1023 831 1458 1182"> <p>Free programming (MOVI-PLC® / MOVITOOLS® MotionStudio)</p> <ul style="list-style-type: none"> – Programming in accordance with IEC 61131 (e.g. in LD, FBD, STL, ST, SFC) – MOVITOOLS® MotionStudio with PLC Editor, Application Builder, etc. – Multi-level library concept (application and program modules of the MOVI-PLC® controller series) – PLCopen-certified motion blocks </td> </tr> </table>	<p>MOVIFIT® FC Classic standard inverters Simple and standardized functions</p>	<p>MOVIFIT® FC Technology application inverters Parameterizable application modules:</p> <ul style="list-style-type: none"> – Standardized functions – Control and diagnostics via fieldbus – Setting parameters instead of programming – Startup and diagnostics using MOVITOOLS® MotionStudio 	<ul style="list-style-type: none"> – “Easy mode”: easy startup using DIP switches possible – Standardized drive functions – Control as fieldbus gateway – Extended configuration and diagnostics options via gateway configurator 	<p>Free programming (MOVI-PLC® / MOVITOOLS® MotionStudio)</p> <ul style="list-style-type: none"> – Programming in accordance with IEC 61131 (e.g. in LD, FBD, STL, ST, SFC) – MOVITOOLS® MotionStudio with PLC Editor, Application Builder, etc. – Multi-level library concept (application and program modules of the MOVI-PLC® controller series) – PLCopen-certified motion blocks
<p>MOVIFIT® FC Classic standard inverters Simple and standardized functions</p>	<p>MOVIFIT® FC Technology application inverters Parameterizable application modules:</p> <ul style="list-style-type: none"> – Standardized functions – Control and diagnostics via fieldbus – Setting parameters instead of programming – Startup and diagnostics using MOVITOOLS® MotionStudio 				
<ul style="list-style-type: none"> – “Easy mode”: easy startup using DIP switches possible – Standardized drive functions – Control as fieldbus gateway – Extended configuration and diagnostics options via gateway configurator 	<p>Free programming (MOVI-PLC® / MOVITOOLS® MotionStudio)</p> <ul style="list-style-type: none"> – Programming in accordance with IEC 61131 (e.g. in LD, FBD, STL, ST, SFC) – MOVITOOLS® MotionStudio with PLC Editor, Application Builder, etc. – Multi-level library concept (application and program modules of the MOVI-PLC® controller series) – PLCopen-certified motion blocks 				
<p>safetyDRIVE functional safety</p>	<p>Safety functions integrated in MOVIFIT® in accordance with IEC 61800-5-2:</p> <ul style="list-style-type: none"> – Safe disconnection (STO) – Safe stopping SS1(a) and SS1(c) – Safe motion (SDI, SLS) – Approval in accordance with: <ul style="list-style-type: none"> - Performance level d according to EN ISO 13849-1 - SIL 2 according to IEC 61800-5-2 <p>Safety options S11 and S12</p> <ul style="list-style-type: none"> – PROFIsafe connection or independent operation (different numbers of safe inputs and outputs) 				

6.4 Decentralized installation: inverters

MOVIPRO® standard and application inverters



MOVIPRO®

	MOVIPRO® SDC standard inverters – Decentralized drive inverter with position- ing control	MOVIPRO® ADC application inverters – Compact and freely programmable control- ler for decentralized drive technology
Features	<ul style="list-style-type: none"> – Speed control and positioning – Optional encoder feedback for motor and track – Integrated brake control with different brake voltages – Optional regenerative power supply (only ADC) – Fieldbus interfaces: PROFIBUS, PROFINET, PROFIsafe, EtherNet/IP™, Modbus/TCP, DeviceNet™ – Integrated digital inputs and outputs – Optional RS485, SBus, and SBUS^{PLUS} interfaces for external actuators and sensors – Plug-in interfaces for power, motor (power rating) and encoder (signals) – Local memory for parameters – IP54 degree of protection – Robust aluminum housing – Optional maintenance switch – Optional, separable connection unit for linear power bus 	
Technical data	<ul style="list-style-type: none"> – Power range from 2.2 kW to 22 kW <ul style="list-style-type: none"> - Size 0: 2.2 kW - Size 1: 4 kW, 7.5 kW - Size 2: 11 kW, 15 kW, 22 kW – Voltage range 3x 380 V to 500 V / 50 Hz to 60 Hz – 12 DI + 4 DI/O with function level Classic and PROFINET fieldbus 	
safetyDRIVE functional safety	<ul style="list-style-type: none"> – Safe Torque Off (STO) up to PL d according to EN ISO 13849-1 – Optional: safe PROFIsafe bus system – Optional only for ADC: safe brake control (SBC) 	

6.5 Accessories and options

Software



MOVITOOLS® MotionStudio engineering software

Features

- Modular software concept for consistent engineering:
Startup, control, diagnostics, communication, and visualization
- For parameterizing, programming, and diagnosing most inverter series of SEW-EURODRIVE – independent of the device



MOVIVISION® parameterizable plant software

Features

- Intuitive software solution for system manufacturers and operators
- Simple and fast startup of a drive system
- Can be used at any time and any place
- No special programming knowledge is required – only parameters have to be entered

→ More information on the software: pages 310 – 315

07

SERVO DRIVE TECHNOLOGY

Technical data:

→	See chapter 01		
	Servo gearmotors		
	Planetary servo gearmotors, PS.F..CMP../CM../ PS.C..CMP/CM.. series	106	
	Helical-bevel servo gearmotors, BS.F..CMP../CM.. series	107	
	NEW: Precision servo gearmotors, ZN..CMP(Z).. / ZN..CM.. series 2	108	
	Helical servo gearmotors, RX/R..CMP../CM../DRL..	109	
	Parallel-shaft servo gearmotors, F..CMP../CM../DRL..	110	
	Helical-bevel servo gearmotors, K..CMP../CM../DRL..	111	
	Helical-worm servo gearmotors, S..CMP../CM../DRL..		
	SPIROPLAN® servo right-angle gearmotors,	112	
	W..CMP../CM../DRL..	113	
	Explosion-proof servo gearmotors	117	
→	See chapter 02		
	Servo gear units		
	Planetary servo gear units, PS.F, PC.C series	128	
	Helical-bevel servo gear units, BS.F series	130	
	Explosion-proof servo gear units	135	
	Accessories and options for gear units	136	
	Surface and corrosion protection	138	
	TorqLOC® hollow shaft mounting system	141	
→	See chapter 03		
	Servomotors		
	CMP.. synchronous servomotors (high dynamics)	166	
	NEW: Synchronous servomotors in encoderless design	168	
	CM.. synchronous servomotors (high inertia)	170	
	DRL.. asynchronous servomotors	171	
	Explosion-proof CMP. servomotors	172	
	Accessories and options for motors		
	Cables and connection options	174	
	Linear motion	176	
	SL2 synchronous linear servomotors	176	
	CMS.. standard electric cylinders	177	
	CMSM.. modular electric cylinders	180	
→	See chapter 06		
	Inverter technology		
	Control cabinet installation	244	
	MOVIDRIVE® B application inverters	248	
	MOVIDRIVE® MDR60A../MDR61A.. regenerative power supply	250	
	MOVIAXIS® multi-axis servo inverters	251	
	effiDRIVE®: energy efficiency in servo applications	262	
	Accessories and options: Software		
	– MOVITOOLS® MotionStudio engineering software	279	
	– MOVIVISION® plant software	279	

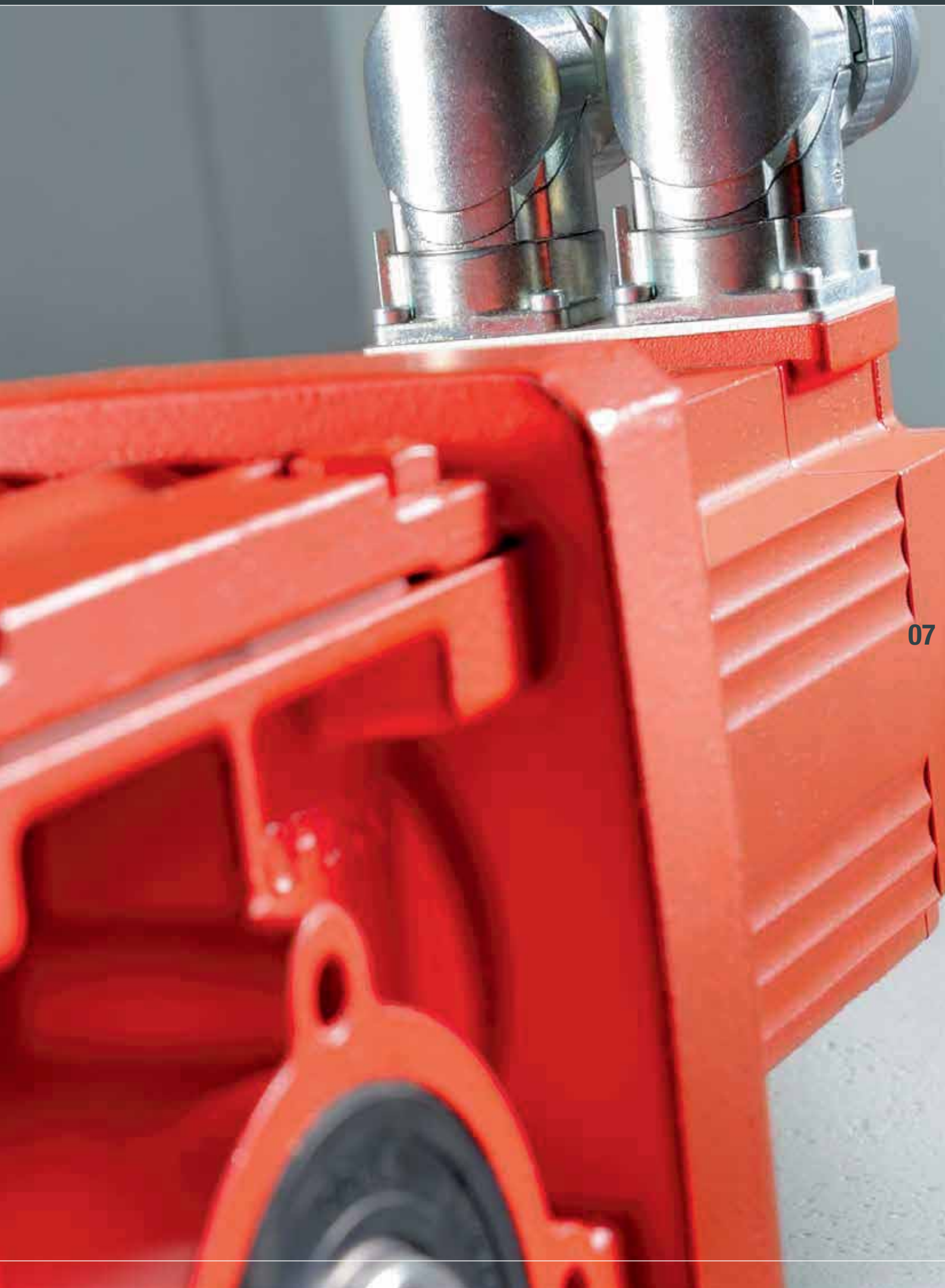

08

INDUSTRIAL COMMUNICATION

8.1 Industrial ETHERNET	284
8.2 Conventional fieldbuses	287
8.3 SEW-EURODRIVE system buses	289
8.4 Communication modules and fieldbus tools	291
8.5 Safe communication	292

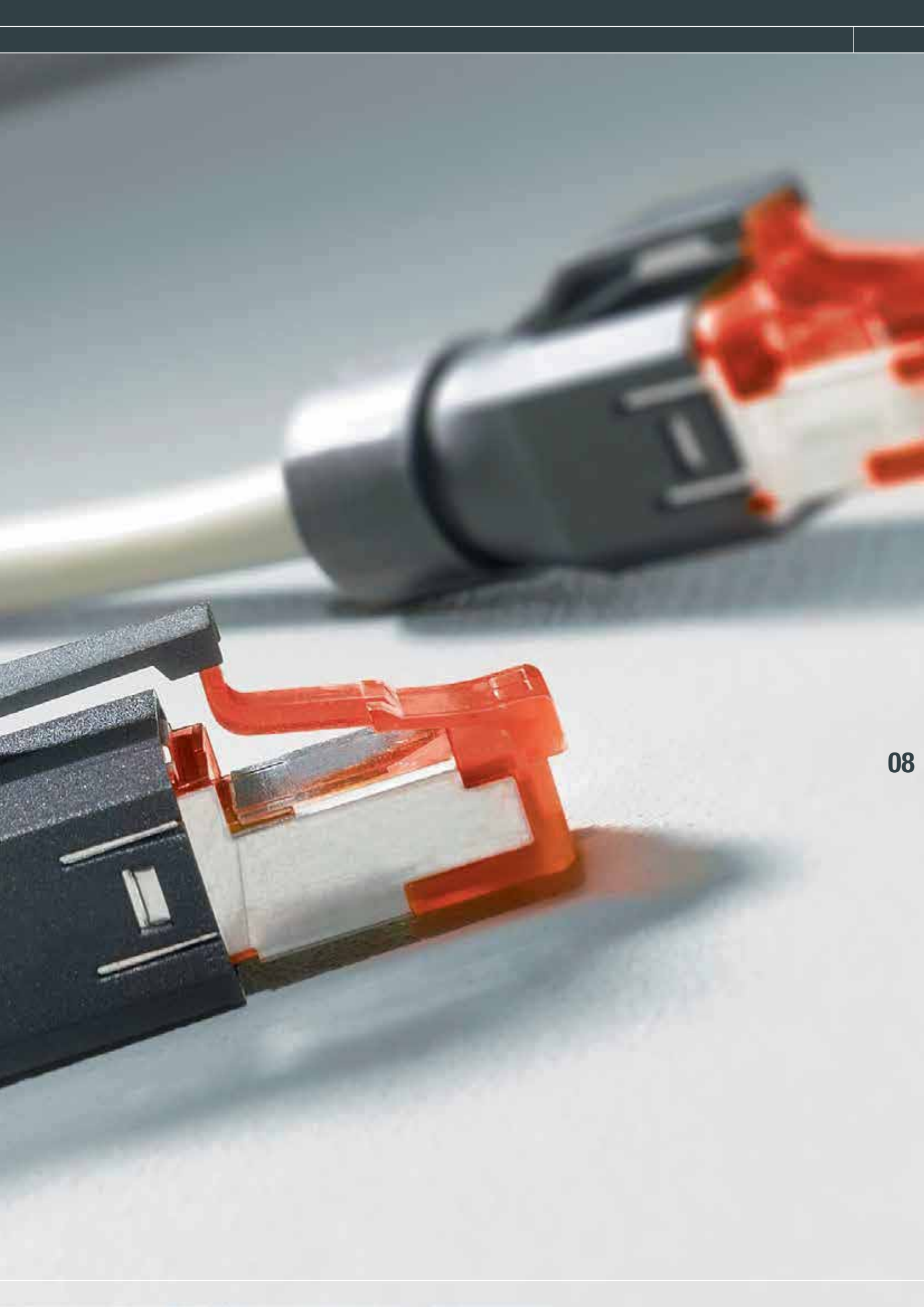

8.1 Industrial ETHERNET

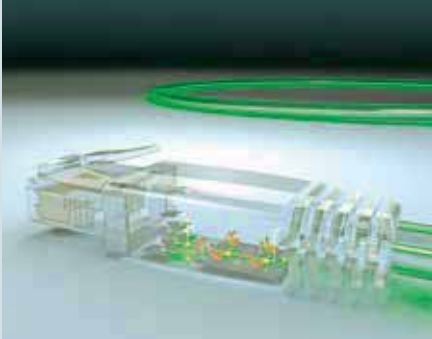

Industrial ETHERNET

One cable – numerous possibilities

- High transmission rate
- Widespread medium
- Enables the use of IT technology, such as e-mail for notification if an error occurs, and diagnostics for the implemented components using the Internet Explorer
- Ensures vertical data communication with the control level with high bandwidth as well as horizontal process data communication between controller and application (e.g. drive inverters)
- Comprehensive service from SEW-EURODRIVE for process data communication

Advantages

- Vertical and horizontal communication using Industrial ETHERNET
- Real-time capable process data communication between controller and drive technology components (soft real time) with 10 process data words (each direction)
- Fast data transfer at 100 Mbit/s
- Diagnostics of drive technology via Internet Explorer, for example
- Programming and diagnostics for the drive technology can be carried out via Ethernet, which makes remote maintenance easy to handle
- Broadband data communication between the control level and field level
- Control and engineering combined in one bus system, saving costs for installation and maintenance
- Fast system integration

Functions

- Process data communication by means of protocol, either PROFINET IO/RT, EtherNet/IP™, MODBUS TCP or EtherCAT® for simple and fast exchange of data between control level and field level
- Control and diagnostics via Ethernet – local operation, diagnostics, and maintenance at the field level
- Integrated web server (not EtherCAT®) to diagnose the drive technology via Internet Explorer
- Central data backup at control level
- Parameter setting and programming using MOVITOOLS® MotionStudio via Ethernet
- Reduction of installation costs and maintenance due to installation of only one diagnostic bus or engineering bus system

Overview of fieldbus options

Industrial ETHERNET	PROFINET® 	EtherNet/IP™ 	Modbus TCP 	EtherCAT® 
----------------------------	---	--	---	---

Inverter technology – control cabinet installation and wall mounting

MOVITRAC® LTE basic inverter	DFE32B/UOH option	DFE33B/UOH option	DFE33B/UOH option	DFE24B/UOH option
MOVITRAC® LTP standard inverter	Options – DFE32B/UOH – DHR controller – LTFE32A	Options – DFE33B/UOH – DHR controller – LTFE33A	Options – DFE33B/UOH – DHR controller – LTFE31A	Options – DFE24B/UOH – LTFE24A

Inverter technology – control cabinet installation

MOVITRAC® B standard inverter	Options – DFE32B – DFE32B/UOH – DFS21B/PROFIsafe	Options – DFE33B – DFE33B/UOH	Options – DFE33B – DFE33B/UOH	Options – FSE24B – DFE24B – DFE24B/UOH
MOVIDRIVE® B application inverter	Options – DFE32B – DFS21B/PROFIsafe	DFE33B option	DFE33B option	DFE24B option
MOVIAXIS® multi-axis servo inverter	Options – UFR41B – DHR controller	Options – UFR41B – DHR controller	Options – UFR41B – DHR controller	XFE24A option

8.1 Industrial ETHERNET

Overview of fieldbus options

Industrial ETHERNET	PROFINET® 	EtherNet/IP™ 	Modbus TCP 	EtherCAT® 
----------------------------	---	--	---	---

Decentralized inverters

MOVIMOT® standard inverter	Options – MFE52A – Optional MOVIFIT® MTM PROFIsafe	MOVIMOT® MTM option – MFE62	MOVIMOT® MTM option	MFE72A option
– MOVIFIT® SC motor starter – MOVIFIT® MC distributor for MOVIMOT® – MOVIFIT® FC standard inverter	On-board interface PROFIsafe (optional)	On-board interface	On-board interface	
MOVIPRO® standard inverter	On-board interface PROFIsafe (optional)	On-board interface	On-board interface	





Decentralized drives / mechatronics

Gearmotor with integrated MOVIMOT® inverter	Options – MFE52A – Optional MOVIFIT® MTM PROFIsafe	MOVIMOT® MTM option – MFE62	MOVIMOT® MTM option	MFE72A option
MOVIGEAR® SNI and DRC...SNI electronic motor	On-board interface in MOVIFIT® FDC	On-board interface in MOVIFIT® FDC	On-board interface in MOVIFIT® FDC	
MOVIGEAR® DSC and DRC...DSC electronic motor	Options – DFE32B/UOH – DFS21B/PROFIsafe	DFE32B/UOH option	DFE32B/UOH option	DFE24B/UOH option
Fieldbus gateway	Options – UFR41B – DFE32B/UOH	Options – UFR41B – DFE33B/UOH	Options – UFR41B – DFE33B/UOH	DFE24B/UOH option
MOVI-PLC® controller and CCU (Configurable Control Unit) as well as MOVIFIT® FDC	On-board interface DHR	On-board interface DHR	On-board interface DHR	

8.2 Conventional fieldbuses

Features	<ul style="list-style-type: none"> – Smooth communication on all levels of the system structure – Basis for efficient, flexible automation concepts, allow for economic startups and smooth production processes – Global standard as conventional fieldbuses are used worldwide
-----------------	---

Overview of fieldbus options

Conventional fieldbuses	PROFIBUS® 	INTERBUS 	DeviceNet™ 	CANopen 	AS-Interface 
--------------------------------	---	--	--	---	--

Inverter technology – control cabinet installation and wall mounting





MOVITRAC® LTE basic inverter	DFP21B/UOH option	UFI11A option	DFD11B/UOH option	UFO11A option	
MOVITRAC® LTP standard inverter	Options <ul style="list-style-type: none"> – DFP21B/UOH – DHF controller – LTFP11A 	UFI11A option	Options <ul style="list-style-type: none"> – DFD11B/UOH – DHF controller – LTFD11A 	On-board interface	

Inverter technology – control cabinet installation

MOVITRAC® B standard inverter	Options <ul style="list-style-type: none"> – DFP21B – DP21B/UOH – DFS11B/PROFIsafe 	UFI11A option	Options <ul style="list-style-type: none"> – DFD11B – DFD11B/UOH 	On-board interface	
MOVIDRIVE® B application inverter	Options <ul style="list-style-type: none"> – DFP21B – DFS11B/PROFIsafe 	DFD11B/21B option	DFD11B option	On-board interface	
MOVIAXIS® multi-axis servo inverter	Options <ul style="list-style-type: none"> – XP11A – UFF41B – DHF controller 		Options <ul style="list-style-type: none"> – XP11A – DHF controller 		

8.2 Conventional fieldbuses

Overview of fieldbus options

Conventional fieldbuses	PROFIBUS® 	INTERBUS 	DeviceNet™ 	CANopen 	AS-Interface 
--------------------------------	---	--	--	---	--

Decentralized inverters

MOVIMOT® standard inverter	MFP/MQP option	MFI option	Options – MFD/MQD – MOVIMOT® MTM option		On-board interface
– MOVIFIT® SC motor starter – MOVIFIT® MC distributor for MOVIMOT® – MOVIFIT® FC standard inverter	On-board interface, PROFIsafe optional		On-board interface		On-board interface in MOVIFIT® basic
MOVIPRO® standard inverter	On-board interface, PROFIsafe optional		On-board interface		

Decentralized drives / mechatronics

Gearmotor with integrated MOVIMOT® inverter	MFP/MQP option	MFI option	Options – MFD/MQD – MOVIMOT® MTM		On-board interface
MOVIGEAR® SNI and DRC..-SNI electronic motor	Options – UFF41B/OMG42 – On-board interface in MOVIFIT® FDC		Options – UFF41B/OMG42 – On-board interface in MOVIFIT® FDC		
MOVIGEAR® DSC and DRC..-DSC electronic motor	Options – DFP21B – DFS11B/PROFIsafe	UFI11A option	DFD11B/UOH option	UFO11A option	On-board interface
Fieldbus gateway	Options – UFF41B – DFP21B/UOH	UFI11A option	Options – UFF41B – DFD21B/UOH	UFO11A option	
MOVI-PLC® controller and CCU (Configurable Control Unit) as well as MOVIFIT® FDC	On-board interface DHP/DHF		On-board interface DHF		

8.3 SEW-EURODRIVE system buses

Features	<ul style="list-style-type: none"> – SEW-EURODRIVE system bus technologies especially designed for control and drive technology from SEW-EURODRIVE: Can be used in centralized and decentralized system concepts – SEW-EURODRIVE system buses are perfectly designed and preset for drive electronics and controllers <ul style="list-style-type: none"> - Reduced installation work as interfaces are avoided or completely integrated - Fast data exchange - Integrated diagnostics concept
Technologies	<p>SNI (Single Line Network Installation)</p> <p>Combines the advantages of reduced installation work with the technology of Ethernet-based communication in one innovative drive infrastructure solution.</p> <ul style="list-style-type: none"> – Use of the electrical energy infrastructure as basis for the transmission of Ethernet-based communication signals – Ethernet-based access to all individual stations from a central point – Significantly reduced installation effort as only supply cables need to be connected – Maximum expansion of the line topology for up to 10 drives with a total of 100 m cable length – Installation with shielded standard cables according to the SEW-EURODRIVE regulations; no special cables are necessary <hr/> <p>SBus (CAN-based SEW-EURODRIVE system bus)</p> <p>The CAN technology was developed for mobile applications and is also used in automation applications</p> <ul style="list-style-type: none"> – Consistent use of the multi-master functionality of the CAN for data exchange between the drives; in some projects without any additional controller possible – The SBus allows for applications that require hard real-time conditions for the communication. The clock-synchronous transmission of setpoint and actual values between the drives or within the network with a controller makes for applications such as "electronic gear unit" and "multi-axis MotionControl". – Inexpensive networking due to use of standard CAN bus cables, in the control cabinet with separable screw connection, in decentralized solutions with the M12 plug connectors standardized for DeviceNet™ or CANopen – Maximum expansion of the line topology up to 500 m. The number of drives and peripheral components is limited to 64, but is usually less than 20. <hr/> <p>SBus^{PLUS} (EtherCAT®)</p> <p>In addition to ideal integration, SBus^{PLUS} offers additional functions in networks with our controllers and drive technology that allow for easy and simple startup.</p> <ul style="list-style-type: none"> – EtherCAT® is a hard real time-capable communication technology that can be flexibly installed – Star, tree and line topologies can be implemented with stub lines nearly without any performance losses – For further information refer to ETG (EtherCAT Technology Group) http://www.ethercat.org

8.3 SEW-EURODRIVE system buses

Device family	Decentralized controller MOVIFIT® FDC-SNI		DHx21 control card		DHx41 control card		UHX71B control card	
	CCU software: parameterizable solutions	MOVI-PLC® software: free programming	CCU software: parameterizable solutions	MOVI-PLC® software: free programming	CCU software: parameterizable solutions	MOVI-PLC® software: free programming	MOVI-PLC® software: free programming	
System bus	SBus (CAN) and SNI		SBus (CAN)		SBus (CAN)	SBus ^{PLUS} (EtherCAT®)	SBus ^{PLUS}	SBus on OSC71B

Control cabinet

MOVITRAC® B			via FSC	via FSC	via FSC	Yes	via FSE24B	via FSE24B	FSC
MOVIDRIVE® B			Yes	Yes	Yes	Yes	via DFE24B	via DFE24B	
MOVITRAC® LTX			Yes	Yes	Yes	Yes			Yes
MOVIAXIS®					Yes	Yes	via XFE/XSE	via XFE/XSE	

Control cabinet and decentralized installation

MOVITRAC® LTE-B	Yes ¹⁾	Yes	Yes ¹⁾	Yes	Yes ¹⁾	Yes			Yes
MOVITRAC® LTP-B	Yes ¹⁾	Yes	Yes ¹⁾	Yes	Yes ¹⁾	Yes			Yes

Decentralized drives / mechatronics

MOVIGEAR® SNI	Yes	Yes							
MOVIGEAR® DSC	Yes	Yes	Yes	Yes	Yes	Yes			Yes
MOVIFIT® slave	Yes	Yes		Yes		Yes			
MOVIAXIS® MD							Yes		

Accessories

I/O system		via OCC		via OCC		via OCC	via OCE	via OCE	
------------	--	---------	--	---------	--	---------	---------	---------	--

¹⁾ Only 3PD speed control

8.4 Communication modules and fieldbus tools

Features	Simplify communication between control and drive components and establishing communication structures.
Communication modules	Are offered in several technology program packages. This example of SEW-EURODRIVE is a free of charge, non-binding service and shows the basic procedure for creating a PLC program. SEW-EURODRIVE is not liable for the content of the sample program.
Fieldbus tools	Do not hesitate to contact us: We will be happy to provide simple Ethernet masters for the exchange of processes and parameters – from Windows PCs with Ethernet interface – to SEW-EURODRIVE devices with EtherNet/IP™ or MODBUS-TCP interfaces

8.5 Safe communication



Certified to (IEC 61508) SIL 3, (EN ISO 13489-1) PL e

The safety functions Safe Torque Off (STO) and Safe Stop (SS1) according to IEC 61800-5-2 can be activated for **MOVIDRIVE® B** application inverters and **MOVITRAC® B** standard inverters via the following options.

- MOVISAFE® DFS11B for connecting MOVIDRIVE® B / MOVITRAC® B: PROFIsafe on PROFIBUS DP
- MOVISAFE® DFS21B for connecting MOVIDRIVE® B / MOVITRAC® B: PROFIsafe on PROFINET IO

These components come equipped with a safety-related output used for the safe disconnection of individual MOVIDRIVE® B / MOVITRAC® B inverters or a group of MOVIDRIVE® B / MOVITRAC® B inverters.

MOVIMOT® gearmotors with integrated inverter can be controlled using PROFIBUS/PROFIsafe when the gearmotors are used together with MQS../Z.6F field distributors. Field distributors with integrated MOVIMOT® inverter of the MQS../Z.7F and MQS../Z.8F type are also equipped with a PROFIBUS/PROFIsafe interface.

The decentralized **MOVIFIT®** drive controller can also be controlled via PROFIsafe in connection with MOVIFIT® MC or FC with S12 safety option. The S12 safety option, certified to IEC 61800-5-2 and EN ISO 13849-1, is an integrated and parameterizable option card with safe inputs and outputs (F-DI, F-DO) that can also evaluate safety-related motor encoders. These functions allow you to connect safety technology sensors for disconnection purposes and monitoring functions for speed and direction of rotation.

Control cabinet drive technology: Functional safety integrated in the inverter

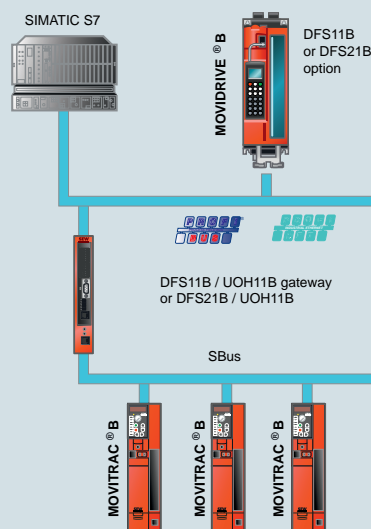

Decentralized installation

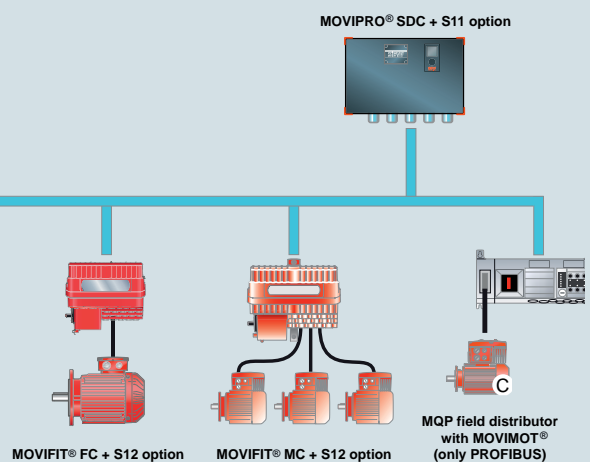

Certified to (IEC 61508) SIL 3, (EN ISO 13489-1) PL e

- Additional safe motion functions according to IEC 61800-5-2 can be implemented for **MOVIDRIVE® B** application inverters from size 1. These functions are SS1, SS2, SOS, SDI, SLS, SSR, SLA, SAR, SSM, SLI, SCA, and SLP.
- Combining the **MOVISAFE®** DCS21B or DCS22B option card with the DFS12B (PROFIBUS) or DFS22B (PROFINET IO) fieldbus interface enables control via PROFIsafe.
- The UCS..B safety module has all the safety functions for monitoring the movements of **MOVIAXIS®** multi-axis servo inverters. Safe data is exchanged with the controller via PROFIsafe.

The modular **MOVIPRO®** concept comprises the following safety options:

- Control via PROFIsafe with PROFIsafe option S11
- The integrated PROFIsafe option S11 comes equipped with 4 safety-related inputs for connecting safe sensors and 2 safety-related outputs
- Optional, safe brake control (SBC)
- Decentralized MOVISAFE® HM31 safety controller for independent, safety-relevant control of application solutions, with integrated safe master-slave communication

Control cabinet drive technology: Modular safety in inverters

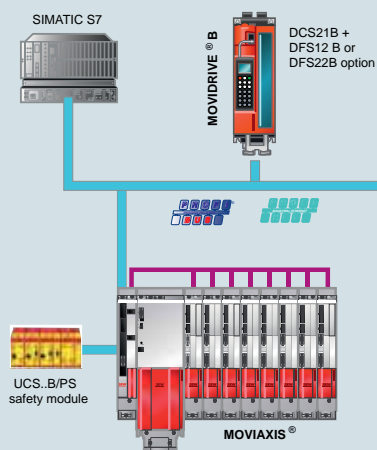

Decentralized installation

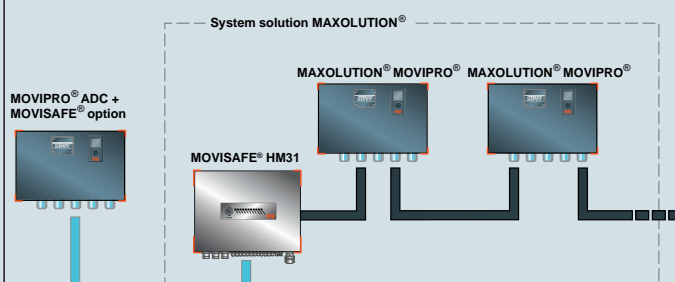

* MOVIPRO® ADC with MOVISAFE® HM31 option
only in connection with MAXOLUTION® system solutions

09

CONTROL TECHNOLOGY

9.1 Controller hardware

Decentralized controllers	
MOVIFIT® MTx Technology	296
MOVIFIT® FDC-SNI	297
MOVIPRO® ADC	298
Controllers for control cabinet installation	
Controller performance class “standard”	299
Controller performance class “advanced”	300
Controller performance class “power”	301
Accessories and options	302

9.2 Controller software

Free programming MOVI-PLC®	304
Parameterizable solutions CCU	305

9.3 Operator panels

Device generation DOP11C	306
--------------------------	-----



9.1 Controller hardware

Decentralized controllers



MOVIFIT® MTx Technology

Features

- MOVIFIT® function level technology
- With integrated basic control card
- For decentralized field installation up to degree of protection IP69
- As freely programmable motion and logic controller (MOVI-PLC®) with libraries and program modules specifically designed for materials handling applications
- As parameterizable configurable control unit (CCU) with special application modules for materials handling applications, such as cam or simple positioning

Technical data

- PROFIBUS slave DP-V1, PROFINET, EtherNet/IP™
- 2 CAN interfaces, 1 of which is electrically isolated
- 1 RS485 interface
- 8 digital I/Os (inputs/outputs)
- Status display for controller (programmable logic controller) and fieldbus



MOVIFIT® FDC-SNI

Features

- MOVIFIT® FDC-SNI with integrated control card available in standard and advanced performance class
- Module controller for up to 16 axes via SBus or a maximum of 10 MOVIGEAR® SNI
- As freely programmable motion and logic controller (MOVI-PLC®) with libraries and program modules specifically designed for materials handling applications
- As configurable control unit (CCU) with special application modules for materials handling such as rapid/creep speed positioning, bus positioning or universal module
- Motion and logic controller for response times > 10 ms
- Single-axis motion control libraries and program modules
- SD memory card for easy device replacement and recipe management
- Fast engineering via USB and Ethernet

Technical data

- 1x Ethernet (10/100 BaseT) for engineering or TCP/IP and UDP via IEC 61131-3
- 1x CAN, electrically isolated
- 1x SNI
- 1x RS485, electrically isolated
- USB interface
- PROFINET slave, Ethernet/IP™ slave, Modbus TCP/IP slave
- 12 digital inputs and 4 digital inputs/outputs
- Status display for PLC and fieldbus
- Real-time clock
- 2 MB program memory, 6 MB data memory
- 32 kB retain variables, 24 kB system variables (retain)
- Free-running task (min. 10 ms), 1 cyclic task (10 to 10 000 ms)
- PC-readable memory card for firmware and application program

9.1 Controller hardware

Decentralized controllers



MOVIPRO® ADC advanced

Features

- MOVIPRO® ADC with integrated control card advanced
- For compact performance with decentralized field installation up to IP54
- As a freely programmable motion and logic controller with libraries and program modules specifically for materials handling technology applications
- As a configurable control unit (CCU) with special application modules for materials handling and positioning applications, such as universal mode and rapid/creep speed positioning
- Motion and logic controller for very short response times
- Technology motion control libraries and program modules, such as electronic gear unit, electronic cam
- SD memory card for easy device replacement
- Fast engineering via USB and Ethernet

Technical data

- 1x Ethernet interface (10/100 BaseT) for engineering tasks or TCP/IP and UDP via IEC 61131-3
- 1x Ethernet interface as SBUS^{PLUS} (EtherCAT®) master
- 1x CAN interface, electrically isolated
- 1x RS485 interface, electrically isolated
- PROFIBUS slave DP-V1, DeviceNet™ slave (DHF41B)
- PROFINET slave, EtherNet/IP™ slave, Modbus TCP/IP slave
- 12 digital inputs and 4 digital inputs/outputs
- Status display for PLC and fieldbus
- PC-readable memory card for firmware and application program

Controllers for control cabinet installation



Controller performance class “standard”

Control card standard DHx21B

Variants	<ul style="list-style-type: none"> – DHE21B with Ethernet interface – DHF21B with additional PROFIBUS and DeviceNet™ slave interface – DHR21B additionally with PROFINET / EtherNet IP / Modbus TCP/IP slave interface
Features	<ul style="list-style-type: none"> – Motion and logic controller for medium response times – MultiMotion Light motion operating system – Motion control for up to 16 axes via SBus – MOVI-PLC® I/O system via SBus – SD memory card for easy device replacement and recipe management – Fast engineering via USB and Ethernet
Technical data	<ul style="list-style-type: none"> – 1x Ethernet interface (10/100 BaseT) for engineering tasks or TCP/IP and UDP via IEC 61131-3 – 2 CAN interfaces, 1 of which is electrically isolated – 2 RS485 interfaces, 1 of which is electrically isolated – USB device – DHF21B version with PROFIBUS slave DP-V1, DeviceNet™ slave – DHR21B version with PROFINET slave, EtherNet/IP™ slave, Modbus TCP/IP slave – 8 digital I/Os (inputs/outputs) – Status display for PLC and fieldbus – Real-time clock – 2 MB program memory, 6 MB data memory – 32 kB retain variables, 24 kB system variables (retain) – Free-running task (min. 10 ms), 1 cyclic task (10 to 10 000 ms) – PC-readable memory card for firmware and application program

9.1 Controller hardware

Controllers for control cabinet installation



Controller performance class “advanced”

DHx41B control card

Variants	<ul style="list-style-type: none"> – DHE41B with Ethernet interface – DHF41B with additional PROFIBUS and DeviceNet™ slave interface – DHR41B additionally with PROFINET / EtherNet IP™ / Modbus TCP/IP slave interface
Features	<ul style="list-style-type: none"> – Motion and logic controller for short response times – MultiMotion motion operating system and technology modules – Motion control for up to 64 axes via SBus, or high performance with SBUS^{PLUS} – MOVI-PLC® I/O system via SBus, or high performance with SBUS^{PLUS} – SD memory card for easy device replacement and recipe management – Fast engineering via USB and Ethernet
Technical data	<ul style="list-style-type: none"> – 1x Ethernet interface (10/100 BaseT) for engineering tasks or TCP/IP and UDP via IEC 61131-3 – 1x Ethernet interface as SBUS^{PLUS} (EtherCAT®) master – 2 CAN interfaces, 1 of which is electrically isolated – 2 RS485 interfaces, 1 of which is electrically isolated – USB device – DHF41B version with PROFIBUS slave DP-V1, DeviceNet™ slave (DHF41B) – DHR41B version with PROFINET slave, EtherNet/IP™ slave, Modbus TCP/IP slave – 8 digital I/Os (inputs/outputs) – Status display for PLC and fieldbus – 4 MB program memory, 12 MB data memory – 32 kB retain variables, 24 kB system variables (retain) – Free-running task (min. 10 ms), 8 cyclic tasks (1 to 10 000 ms) – PC-readable memory card for firmware and application program



Controller performance class “power”

UHX71B control card

Variants

- UHX71B with Ethernet interface
- UHX71B-OSP71B version with additional PROFIBUS slave interface
- UHX71B-OSR71B version with additional PROFINET / EtherNet/IP™ / Modbus TCP/IP slave interface

Features

- Available in versions T0 – T25
- Reduced interfaces, meaning all functions are controlled by one controller
 - Demanding technology functions, such as cams or electronic gear unit
 - 3D robotics functions with up to 8 degrees of freedom
- Simple high-performance implementation of most complex machines
- Up to 32 centrally calculated motion control axes in one millisecond
- Sufficient processing power available even for the most demanding application programs
- Fast, clock-synchronous SBUS^{PLUS} for coordinating the drives
- CFast memory card for firmware, application and user data makes for easy device replacement and extremely quick data access

Technical data

- Intel Core2Duo 2.2 GHz microprocessor
- 1x GB Ethernet (10/100 BaseT) for engineering tasks or TCP/IP and UDP via IEC 61131-3
- 1x Ethernet interface for SBUS^{PLUS}
- 16 MB program memory, 64 MB data memory
- 32 kB retain variables, 24 kB system variables (retain)
- Free-running tasks and 8 cyclical tasks (1 to 10 000 ms)
- PC-readable memory card for firmware and application program
- CAN interface as an option OSC71B

9.1 Controller hardware

Accessories and options for controllers



Memory cards

Memory cards for “standard” and “advanced” performance class controllers

- OMH41B
- OMC41B
- OMH71B
- OMW71B / OMW72B

ORV71B dongle for UHX71B

Dongle for visualization runtime

High-performance visualization solutions can be implemented using HMI-Builder.PRO and the Windows operating system in MOVI-PLC® power.



I/O expansions

I/O expansions for control cabinet installation and decentralized installation

- MOVI-PLC® I/O system B
 - MOVI-PLC® I/O system C
 - SNI I/O system
- I/O expansions for automating your machine modules and entire systems



Interfaces

CAN interface OSC71B for UHX71B

The OSC71B option allows you to add a CAN bus interface to the existing range of interfaces for MOVI-PLC[®] power. This enables stations to be operated on the MOVI-PLC[®] power controller without the need for SBUS^{PLUS} (MOVIGEAR[®]).

9.2 Controller software

Free programming MOVI-PLC®



Efficient engineering with MultiMotion motion control platform

Advantages

- Universal platform as we provide support for all controllers in all performance classes as well as the entire range of drive electronics
- Extensive functionality thanks to the integration of a wide range of motion control functions
- Convenient parameterization as graphical tools are provided for configuration and diagnostics
- Efficient engineering as many functions can be implemented by merely setting parameters

MultiMotion motion control platform

- For MOVI-PLC® advanced and MOVI-PLC® power as of technology level T2
- Supports up to 64 axes
- Single axis functions: Positioning, referencing, speed control and tracking
- Touchprobe function
- Processing of distance encoders
- Technology functions: Synchronous operation, electronic cam functions, and interpolation with different engagement and disengagement mechanisms
- Brake diagnostics for checking the proper functioning and performance of electromechanical brakes
- Cam switch for up to 8 cam tracks

MultiMotion Light motion control platform

- For MOVI-PLC® standard, MOVI-PLC® advanced and MOVI-PLC® power as of technology level T0
- Supports up to 64 axes
- Single-axis functions: Positioning, referencing, speed control and tracking
- Touchprobe function
- Brake diagnostics for checking the proper functioning and performance of electromechanical brakes
- Processing of distance encoders

Technology modules

- HandlingKinematics
- Kinematics
- Energy-efficient storage/retrieval system
- Winder

Parameterizable solutions (CCU)



Parameterize rather than program using CCU (Configurable Control Unit)

Advantages

- **Parameterization instead of programming** by means of graphical configurators that let you parameterize predefined application and technology modules, which can be run directly.
- **Easy startup** by means of our standardized application modules that let you start quickly without time-consuming programming.
- **Optimize the application** by means of a wide range of diagnostics tools.

Configure applications quickly and easily using our Application Configurator for CCU:

- Graphical configuration of the modules using the PC
- Standardized single-axis and multi-axis application modules can be configured and run directly
- Control of the modules via standardized process data interface
- Pre-startup without higher-level PLC (programmable logic controller) using a special control mode
- Shorter response times when coordinating several axes
- Integrated diagnostics for fast and straight-forward startup

Single-axis application modules

- Speed control
- Universal module: Speed, positioning, modulo, remaining distance
- Universal module Technology, additionally with phase-synchronous operation
- Rapid/creep speed positioning

Multi-axis application modules

- HandlingKinematics: Implementation of kinematics and handling applications
- Energy-optimized coordination of drive and lifting axes for storage/retrieval systems
- Winder: for effortless winding and unwinding of materials
- SyncCrane: for easy control of crane bridges and lifts

Function unit

- The function module enhances the functionality of the respective application module
- Brake diagnostics for checking the proper functioning and performance of electromechanical brakes

9.3 Operator panels

Visualization and diagnostics



Operator panels of the DOP11C generation

Features

- Standardized, modern panel series with touchscreen, high-resolution color display and wide viewing angle
- Consistent product portfolio with screen sizes from 4.3" to 15"
- Optimized on-screen keyboard makes it easier to enter text, even for smaller panels
- Faster processors with improved performance
- More RAM allows you to carry out even the most sophisticated visualization projects
- Option to expand memory by means of an SD card or USB stick, e.g. for logging visualization data
- Flexible communication connection due to sophisticated interfaces and driver protocols
- The new Windows-based platform MOVI-PLC® power is now available for the most demanding visualization tasks for use with durable 12" and 15" monitors. For this purpose, you have to activate runtime visualization in HMI-Builder.PRO with a USB dongle
- Uniform appearance for both Windows-based and panel-based systems
- Housing:
 - DOP11C40/70/100/120 and 150 made of die-cast aluminum
 - DOP11C51, more cost-efficient due to plastic housing

HMI-Builder.PRO operating software



- Optimal interaction between visualization and SEW-EURODRIVE control technology
- Perfect system integration as an integral part of MOVITOOLS® MotionStudio
- Consistent development environment for the entire C series (from the small 4.3" panel through to high-end 15" visualization supported by MOVI-PLC® power)
- Minimal configuration effort thanks to modern, efficient program design
- Numerous integrated HMI functions, such as recipe management, alarm management, integrated Web server and much more, increase operating security and reduce development costs
- For complex visualization tasks, the open scripting functionality in C# offers the full flexibility of the .NET Framework architecture
- Integrated simulation mode allows you to configure and test visualization tasks in advance – even without hardware

Operator panels of the DOP11C generation

Panel type	Display	Operation	Interfaces	Processor/memory
DOP11C-40	4.3", 480 × 272 pixels, 65k colors	Touch display panel (resistive)	RS232, RS422/RS485 interface, Ethernet, SD card slot, USB	ARM9 (400 MHz) – RAM: 128 MB (DDR2) – Application memory: 80 MB
DOP11C-51	5", 800 × 480 pixels 65k colors	Touch display panel (resistive) Limited functionality	RS232, RS422/RS485 interface, Ethernet, USB	ARM9 (400 MHz) – RAM: 128 MB (DDR2) – Application memory: 200 MB
DOP11C-70	7", 800 × 480 pixels, 65k colors	Touch display panel (resistive)	RS232, RS422/RS485 interface, Ethernet, SD card slot, USB	ARM9 (400 MHz) – RAM: 128 MB (DDR2) – Application memory: 80 MB
DOP11C-100	10.4", 640 × 480 pixels, 65k colors	Touch display panel (resistive)	RS232, RS422/RS485 interface, Ethernet, SD card slot, USB	ARM9 (400 MHz) – RAM: 128 MB (DDR2) – Application memory: 80 MB
DOP11C-120	12.1", 1280 × 800 pixels, 262k colors	Touch display panel (resistive)	RS232, RS422/RS485 interface, Ethernet, SD card slot, USB	Intel Atom (1.1 GHz) – RAM: 1 GB (DDR2) – Application memory: > = 1.4 GB
DOP11C-150	15.4", 1280 × 800 pixels, 262k colors	Touch display panel (resistive)	RS232, RS422/RS485 interface, Ethernet, SD card slot, USB	Intel Atom (1.1 GHz) – RAM: 1 GB (DDR2) – Application memory: > = 1.4 GB
Monitor type (MOVI-PLC® power)				
OPT71C-120	12" display, 1280 × 800 pixels, 16 million colors	Touch display monitor in connection with MOVI-PLC® power	DVI, USB interface for touch functionality	
OPT71C-150	15" display, 1280 × 800 pixels, 16 million colors	Touch display monitor in connection with MOVI-PLC® power	DVI, USB interface for touch functionality	
Device type license (MOVI-PLC® power)				
ORV71C	USB license dongle for using the visualization runtime integrated in HMI-Builder.PRO without a time limit			

10 SOFTWARE

10.1 Startup/engineering

Engineering software	
MOVITOOLS® MotionStudio	310
Engineering software LT Shell	312
Engineering software HMIBuilder.Pro	313
Plant software MOVIVISION®	314

10.2 Project planning

Planning and configuration tools	316
Product configurator	316
Project planning tools for functional safety	317

10.3 Control technology

Free programming MOVI-PLC®	318
----------------------------	-----

10.4 Control and inverter technology

Parameterizable application modules CCU	319
---	-----



10.1 Startup/engineering

Engineering software



MOVITOOLS® MotionStudio





Features

- Modular software concept for consistent engineering: Startup, control, diagnostics, communication, and visualization
- For parameterizing, programming, and diagnosing most inverter series of SEW-EURODRIVE – independent of the device
- Convenient drive startup and parameter setting
- Drive diagnostics using the built-in oscilloscope function
- Creation of application and user programs in high-level language C, assembler or IEC 61131-3
- Viewing status of connected devices
- Fieldbus communication diagnostics via bus monitor
- Controlling technology functions
- Ready-to-use modules for various applications
- Electronic nameplates of SEW-EURODRIVE gearmotors are used for automatic motor adjustment

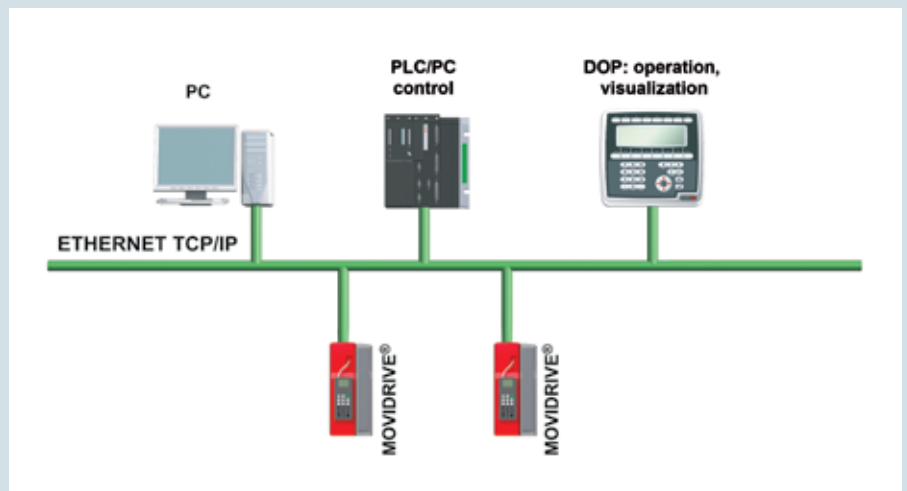
Communication interfaces

- MOVITOOLS® MotionStudio supports engineering via:
- Ethernet TCP/IP, PROFINET IO, EtherNet/IP™, MODBUS TCP
 - EtherCAT®
 - PROFIBUS DPV1, CAN, DeviceNet™
- and the non-proprietary software interface **TCI Tool Calling Interface**



Tool	Functionality
	<p>Startup</p> <ul style="list-style-type: none"> – Configuration and startup: To adapt the inverter to the connected motor and optimize current, speed and position controllers – Manual mode: The tool allows for manually controlling the devices directly from the PC
	<p>Parameter setting</p> <ul style="list-style-type: none"> – Parameter tree: Standardized editor for parameterization of various device types – PDO editor: A process data object editor for graphic configuration of process data for MOVIAXIS® multi-axis servo inverters – Gateway configurator: Uniform tool for diagnostics and configuration of the fieldbus gateways UFx41B, DFX, and MOVIFIT® with Classic and Technology function levels
	<p>Diagnostics and visualization</p> <ul style="list-style-type: none"> – Status: Support for device diagnostics, communicates general device status information, manual device reset possible – Application Builder: Editor for designing application-specific visualization and application-specific diagnostics. Visualization linked to IPOS® inverter program and parameter settings via data download – Fieldbus monitor: Tool for running diagnostics on the communication between the fieldbus and the device (monitor mode), and the setpoint selection on the device independently of the control (control mode) – Scope: Diagnostics are performed by using an oscilloscope program for all SEW-EURODRIVE inverters
	<p>Programming</p> <ul style="list-style-type: none"> – PLC Editor: For programming MOVI-PLC® controllers using custom application programs; can be used independently of the device – IPOS® assembler and compiler

10.1 Startup/engineering

LT Shell software



LT Shell software

Features

- Function-related software for fast startup with parameter management and network monitoring with the aid of a PC
- Multi-language programming tool for MOVITRAC® LTE-B basic inverters, MOVITRAC® LTP-B standard inverters, and MOVIFIT® basic decentralized inverters via RS485 data exchange

Functions

- Uploading and downloading parameters
- Saving parameters
- Exporting inverter parameters
- Controlling the inverter
- Monitoring the state of the motor and inputs/outputs

HMI-Builder.PRO software



HMI-Builder.PRO software

Features

- Optimal interaction between visualization and SEW-EURODRIVE control technology
 - Perfect system integration as an integral part of MOVITOOLS® MotionStudio
 - Consistent development environment for the entire C series (from the small 4.3" panel through to high-end 15" visualization supported by MOVI-PLC® power)
 - Minimal configuration effort thanks to modern, efficient program design
 - Numerous integrated HMI functions, such as recipe management, alarm management, integrated web server and much more, increase operating security and reduce development costs
 - For complex visualization tasks, the open scripting functionality in C# offers the full flexibility of the .NET Framework architecture
 - Integrated simulation mode allows you to configure and test visualization tasks in advance – even without hardware
-

10.1 Startup/engineering

MOVIVISION® plant software



MOVIVISION® parameterizable plant software

Features



- Parameterization instead of programming
- Visual track outline
- Integrated track visualization and operation
- Manual operation
- Virtual pre-startup using plant simulation (2D, 3D)
- Decentralized installation with central data management
- Access authorization management
- Automatic sequence of motion coordination (collision protection, synchronous travel)
- Ensuring independent production flows (routing management, specified targets)
- Parameterizable data exchange with higher-level controller
- Inclusion of production/part data
- Exchanging production-relevant data with higher-level systems
- Special additional functionalities thanks to technological functions (TecUnits)
- Support for safety technology

Advantages

- **Simple planning and configuration**
thanks to parameterizable conveyor functions in combination with virtual configuration, startup, and simulation
- **Simple startup**
thanks to parameterization that does not require special knowledge of programming
- **High flexibility in the event of changes in the production**
thanks to the intuitive operation and parameterization
- **Precise troubleshooting**
thanks to logging, simulation, virtual diagnostics and cause resolution. External support via VPN possible.
- **Increased productivity**
thanks to fast diagnostics, remote maintenance and simple on-site maintenance

Application examples

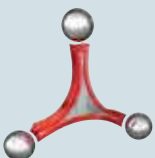
- Single-axis applications such as roller conveyors
- Single or multi-axis applications such as rotary tables, lateral conveyors, lifting/lowering stations, conveyor trolleys
- MAXOLUTION® system solutions such as skillets with lifting tables, electrified monorail systems, and automated guided vehicle systems

Functions	
	<ul style="list-style-type: none"> – Designing and project planning of the system
	<ul style="list-style-type: none"> – Plant data management and administration
	<ul style="list-style-type: none"> – Plant parameterization – Plant startup – Simplified plant maintenance
	<ul style="list-style-type: none"> – Diagnostics of the system – Plant operation and monitoring – Simulation
MOVIVISION® parameter and diagnostics tool	<ul style="list-style-type: none"> – Windows-based parameter and diagnostics tool – User access to the central database of the MOVIVISION® server
MOVIVISION® server	<ul style="list-style-type: none"> – All data is stored in one central database – Establishes a link to the connected decentralized control components – Data is exchanged between server and decentralized control components via fieldbus and/or networks – Parameters are set or changed only in this database – Management and supervision of access authorizations – High degree of data security and user friendliness – Data exchange between server and decentralized components via fieldbuses and/or networks – Activation of automatic parameter download during device replacement – Error analysis possible with logging – Catalog function
MOVIVISION® client	<ul style="list-style-type: none"> – The interface displays the data of the decentralized control components visually – Parameterization and diagnostics on different levels up to the inverter – The data for every device is visualized separately for parameter data and diagnostics data – Users can be granted different access rights, e.g. for monitoring, for parameterizing, for initial startup, for device replacement, etc.

10.2 Project planning

Planning and configuration tools



SEW-Workbench

Features



Download



Registration

- Planning and configuration tool for engineering drive systems
- Suited for simple and complex applications
- Project planning can be checked virtually for proper functioning
- Can be used for several projects at the same time
- Shopping cart can be saved; access/exchange possible among several users
- Result of project planning is saved as product list in PDF format



Product configurator

Features



- Easy online configuration and easy electronic product selection
- Visual support
- Speeds up work
- Complete overview, retrievable CAD data and documentation
- During the quotation and ordering phases, your material number and a specific comment can be saved for the selected product

Project planning tools for functional safety

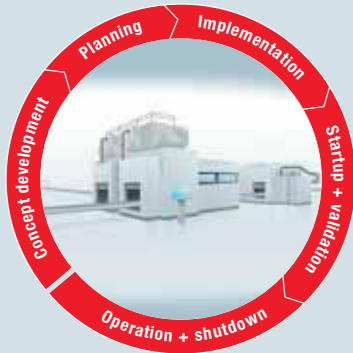

SISTEMA

Project planning tools for functional safety

Evaluation of safety-related machine applications according to DIN EN ISO 13849

Features



Download



PDF

Exclusion of liability

- The SISTEMA software utility (safety of controls on machines) is a calculation tool that offers support in the calculation of safety circuits of controls and sensors on machines and specifically for drive systems as part of DIN EN ISO 13849-1
- The Windows tool models the structure of the safety-related parts of control systems (SRP/CS) based on so-called designated architectures and calculates the reliability values at various levels of detail, including that of the attained performance level (PL)
- The latest version of the SISTEMA software utility is available on the website of the Institute for Occupational Safety and Health of the German Social Accident Insurance: www.dguv.de/en



Safety Configuration Library (SCL)

Selection aid/preselection of drive technology components from SEW-EURODRIVE for functional safety technology. The pictures shown are simplified and not exhaustive. The drive technology components shown in these pictures have to be configured according to the application and must be validated under safety-relevant aspects.

Operating principle

Using the navigation, you can conveniently select/configure your required safety concept. With each selection, a corresponding conceptual drawing is generated. This drawing is greatly simplified and provides an overview of the essential components. At the end of the configuration you will obtain a complete conceptual drawing and an overview of the safety functions that can be implemented. This can be downloaded and saved as a PDF file. Our conceptual drawings have been successfully certified by TÜV SÜD.

Observe the latest operating instructions and manuals for the displayed products.

You can download these documents from our website.

- English: <http://scl.sew-eurodrive.com>
- German: <http://scl.sew-eurodrive.de>
- French: <http://scl.usocome.com>



Available in three languages

10.3 Control technology

Free programming MOVI-PLC®



Efficient engineering with MultiMotion motion control platform

Advantages

- Universal platform as we provide support for all controllers in all performance classes as well as the entire range of drive electronics
- Extensive functionality thanks to the integration of a wide range of motion control functions
- Convenient parameterization as graphical tools are provided for configuration and diagnostics
- Efficient engineering as many functions can be implemented by merely setting parameters

MultiMotion motion control platform

- For MOVI-PLC® advanced and MOVI-PLC® power as of technology level T2
- Supports up to 64 axes
- Single axis functions: Positioning, referencing, speed control and tracking
- Touchprobe function
- Processing of distance encoders
- Technology functions: Synchronous operation, electronic cam functions, and interpolation with different engagement and disengagement mechanisms
- Brake diagnostics for checking the proper functioning and performance of electromechanical brakes
- Cam switch for up to 8 cam tracks

MultiMotion Light motion control platform

- For MOVI-PLC® standard, MOVI-PLC® advanced and MOVI-PLC® power as of technology level T0
- Supports up to 64 axes
- Single-axis functions: Positioning, referencing, speed control and tracking
- Touchprobe function
- Brake diagnostics for checking the proper functioning and performance of brakes
- Processing of distance encoders

Technology modules

- HandlingKinematics
- Kinematics
- Energy-efficient storage/retrieval system
- Winder

10.4 Control and inverter technology

Parameterizable application modules CCU



Parameterize rather than program, using CCU (Configurable Control Unit)

Advantages

- **Parameterization instead of programming** by means of graphical configurators that let you parameterize predefined application and technology modules, which can be run directly.
- **Easy startup** by means of our standardized application modules that let you start quickly without time-consuming programming.
- **Optimize the application** by means of a wide range of diagnostics tools.

Configure applications quickly and easily using our Application Configurator for CCU:

- Graphical configuration of the modules using the PC
- Standardized single-axis and multi-axis application modules can be configured and run directly
- Control of the modules via standardized process data interface
- Pre-startup without higher-level PLC (programmable logic controller) using a special control mode
- Shorter response times when coordinating several axes
- Integrated diagnostics for fast and straight-forward startup

Single-axis application modules

- Speed control
- Universal module: Speed, positioning, modulo, remaining distance
- Universal module Technology, additionally with phase-synchronous operation
- Rapid/creep speed positioning

Multi-axis application modules

- HandlingKinematics: Implementation of kinematics and handling applications
- Energy-optimized coordination of drive and lifting axes for storage/retrieval systems
- Winder: for effortless winding and unwinding of materials
- SyncCrane: for easy control of crane bridges and lifts

Function unit

- The function module enhances the functionality of the respective application module
- Brake diagnostics for checking the proper functioning and performance of brakes

11 SAFETY TECHNOLOGY

11.1 Safe systems	322	11.4 Motor options	330
11.2 Control cabinet installation		Integrated safety technology for DR.. AC motors	
Integrated safe communication for inverters		– Encoders	331
– With safe communication MOVISAFE® DFS11B/21B, DCS21B, DCS22B	324	– Built-in encoders	332
– Independent communication MOVISAFE® DCS31B and DCS32B	325	– (Single) brake	333
Modular safety technology for inverters		– Double brake	334
– Safety modules compact (up to two axes) MOVISAFE® UCS10B/PS, UCS11B/PS, UCS12B/PS, UCS14B/PS	326	Integrated safety technology for CMP.. servomotors	
– Safety modules multi-axis (up to 12 axes) MOVISAFE® UCS50B/PS and UCS51B/PS	327	– Encoders	335
11.3 Decentralized installation	328	– (Single) brake	336
		11.5 Brake control	
		Safe brake module BST	337
		11.6 Brake diagnostics	
		Software function for static and dynamic brake diagnostics	338
		11.7 Safety Configuration Library (SCL®)	
		Guide for selecting safety technology components	339

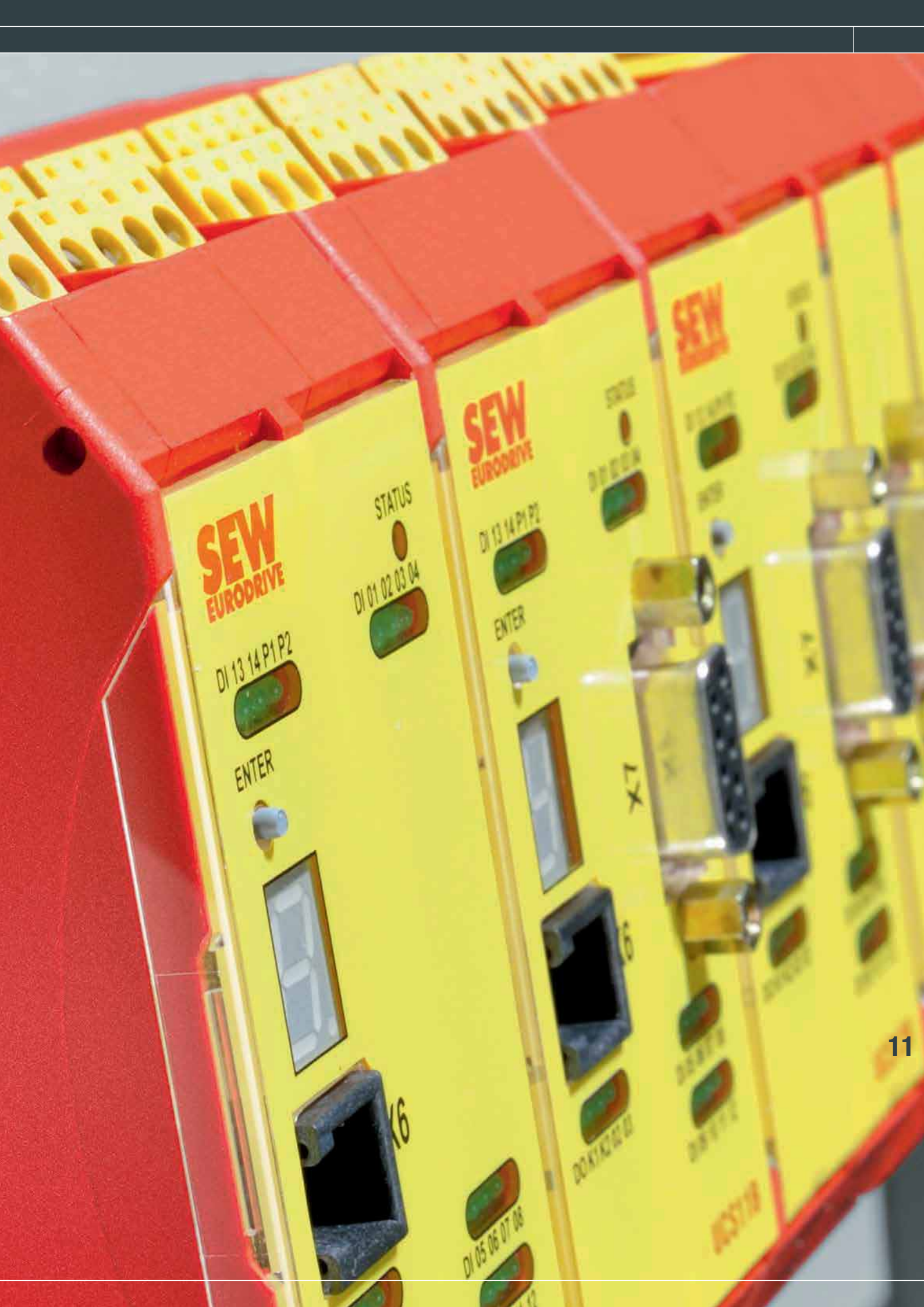

11.1 Safe systems

safetyDRIVE: Functional safety

Continuous further development and automation are the basis for progress and growth in machine and plant manufacturing. At the same time, new challenges emerge: Guaranteeing the safety of all employees and preventing work accidents while ensuring trouble-free production processes are demands placed on all production areas. The installed drive technology makes a significant contribution to the “functional safety” of a machine or plant.

This is where safetyDRIVE, the safety technology concept from SEW-EURODRIVE, comes into play – and not only since the Machinery Directive 2006/42/EC has become effective. safetyDRIVE allows for flexible and economic solutions to allow employees to work in protected areas and to ensure plant operation. Comprehensive safety functions for switching off, stopping and holding as well as for monitoring movements and positions increase the safety in your system. Diagnostic functions monitor the functional effectiveness and performance of safety-relevant components and round off your safety concept.



Modular control cabinet installation



Integrated control cabinet installation



Decentralized installation



Brake control



Motor options brake / encoder



Motor options double brake

11.2 Control cabinet installation

safetyDRIVE: Functional safety in control cabinets



With safe communication

DFS11B/21B for stop functions	<ul style="list-style-type: none"> – Optimized stop monitoring for all drive components – This simplifies the planning and implementation of every type of system
DFS12B/22B for safe communication	<ul style="list-style-type: none"> – Perfectly designed for motion and position monitoring – Easy and compact integration into the MOVIDRIVE® B inverter
MOVISAFE® DCS22B for monitoring motion	<ul style="list-style-type: none"> – Extensive and safe monitoring of motion sequences – Designed for compact integration into MOVIDRIVE® B inverters (sizes 1 to 7)
MOVISAFE® DCS21B for motion and position monitoring	<ul style="list-style-type: none"> – Extensive and safe monitoring of motion and positioning sequences – Easy and compact integration into the MOVIDRIVE® B inverter
Safety functions according to IEC 61800-5-2	<ul style="list-style-type: none"> – MOVISAFE® DFS11B/21B: STO, SS1 – MOVISAFE® DCS21B: STO, SS1, SS2, SOS, SLS, SDI, SSR, SSM, SLI, SCA, SLP – MOVISAFE® DCS22B: STO, SS1, SS2, SOS, SLS, SDI, SSR, SSM
PROFIsafe via PROFIBUS DP or PROFINET IO	<ul style="list-style-type: none"> – MOVISAFE® DFS11B/21B: Communication via PROFIBUS DP or PROFINET IO – MOVISAFE® DCS21B: <ul style="list-style-type: none"> - DFS12B – Communication via PROFIBUS DP - DFS22B – Communication via PROFINET IO – MOVISAFE® DCS22B: <ul style="list-style-type: none"> - DFS12B – Communication via PROFIBUS DP - DFS22B – Communication via PROFINET IO
Number of inputs/outputs	<ul style="list-style-type: none"> – MOVISAFE® DFS11B/21B: <ul style="list-style-type: none"> - 1 safe digital output – MOVISAFE® DCS..B: <ul style="list-style-type: none"> - 8 safe digital inputs - 3 safe digital outputs - Installed axis monitoring function - Designed for integration into the drive inverter – MOVISAFE® DFS11B/21B for MOVIDRIVE® B drive inverters (sizes 0 to 7) and for MOVITRAC® B frequency inverters (sizes 0 to 5) – MOVISAFE® DFS12B/22B for MOVIDRIVE® B drive inverters (sizes 1 to 7) – MOVISAFE® DCS..B for MOVIDRIVE® B drive inverters (sizes 1 to 7)
Application areas for DFS..B and DCS..B safety cards in control cabinet drive technology	<ul style="list-style-type: none"> – Storage and retrieval systems – Trolleys – Cranes – Handling gantries – Baggage handling systems – Assembly sections: press plant, body shop, paint, final assembly



Independent safety technology

MOVISAFE® DCS31B for motion and position monitoring

- Safety functions according to IEC 61800-5-2: STO, SS1, SS2, SOS, SLS, SDI, SSR, SSM, SLI, SCA, SLP
- 8 safe digital inputs
- 3 safe digital outputs
- Integrated axis monitoring function
- Integrated logic processing for connecting inputs/outputs as required
- Designed for integration in MOVIDRIVE® B drive inverters (sizes 1 to 7)

MOVISAFE® DCS32B for motion monitoring

- Safety functions according to IEC 61800-5-2: STO, SS1, SS2, SOS, SLS, SDI, SSR, SSM
- 8 safe digital inputs
- 3 safe digital outputs
- Integrated axis monitoring function
- Integrated logic processing for connecting inputs/outputs as required
- Designed for integration in MOVIDRIVE® B drive inverters (sizes 1 to 7)

Application areas for DCS..B safety cards in control cabinet drive technology

- Storage and retrieval systems
- Trolleys
- Cranes
- Handling gantries
- Baggage handling systems
- Assembly sections: press plant, body shop, paint, final assembly

MOVISAFE®: Functional safety integrated in the inverter

Features

Advantages

- Benefit from the flexibility as our safetyDRIVE components can be individually assembled for every type of system
- Minimize operational risks as the safetyDRIVE functional safety efficiently eliminates all sources of danger
- Drive your system efficiently as the safetyDRIVE safety components save you costs for external safety systems
- Ensure standardized operation as all safetyDRIVE modules comply with the applicable statutory provisions

MOVISAFE®: Modular safety in inverters

- MOVISAFE® DCS..B option cards for the MOVIDRIVE® B drive inverter
- MOVISAFE® UCS..B safety modules for all MOVIAXIS®, MOVITRAC®, MOVIDRIVE® control cabinet inverters
- UCS..B multi-axis logic modules as integrated logic processing for connecting inputs/outputs as required

11.2 Control cabinet installation

Modular safety technology for the inverter



Safety modules – compact (for up to two axes)

	<ul style="list-style-type: none"> – UCS10B safety module – UCS10B/PS safety module: PROFIsafe via PROFIBUS DP/PROFINET IO – UCS11B safety module – UCS11B/PS safety module: PROFIsafe via PROFIBUS DP/PROFINET IO – UCS12B safety module – UCS12B/PS safety module: PROFIsafe via PROFIBUS DP/PROFINET IO – UCS14B/PS safety module: PROFIsafe via PROFIBUS DP/PROFINET IO – UCS26B communication module for optional PROFIBUS DP communication – UCS27B communication module for optional PROFINET IO communication
<p>Features</p>	<ul style="list-style-type: none"> – Integrated logic processing for connecting inputs/outputs as required – Axis monitoring function: <ul style="list-style-type: none"> - UCS10B, UCS10B/PS: without encoder evaluation - UCS11B, UCS11B/PS: for one axis - UCS12B, UCS12B/PS: for up to two axes - UCS14B/PS: for up to two axes with up to two encoders per axis – Safety functions according to IEC 61800-5-2: <ul style="list-style-type: none"> - UCS10B, UCS10B/PS: STO, SS1c - UCS11B, UCS11B/PS, UCS12B, UCS12B/PS, UCS14B/PS: STO, SS1, SS2, SOS, SLS, SDI, SSR, SSM, SLI, SCA, SLP – PROFIsafe via PROFIBUS DP and PROFINET IO for all UCS..B safety modules – Can be extended by input/output modules: <ul style="list-style-type: none"> - Up to 56 safe digital inputs - Up to 23 safe outputs
<p>Areas of application</p>	<ul style="list-style-type: none"> – Scara robots – Application storage/retrieval systems – Handling gantries – Special machine design – Palletizers



Safety modules – multi-axis (for up to 12 axes)

	<ul style="list-style-type: none"> – UCS50B safety module – UCS50B/PS safety module: PROFIsafe via PROFIBUS DP/PROFINET IO – UCS51B safety module – UCS51B/PS safety module: PROFIsafe via PROFIBUS DP/PROFINET IO – UCS50B/DP safety module with PROFIBUS DP – UCS50B/PN safety module with PROFINET IO – UCS61B safety module – UCS62B safety module – UCS63B safety module
Features	<ul style="list-style-type: none"> – Integrated logic processing for connecting inputs/outputs as required – Axis monitoring function for up to 12 axes – Safety functions according to IEC 61800-5-2: SS1, SS2, SOS, SDI, SLS, SSR, SLA, SAR, SSM, SLI, SCA, SLP – PROFIsafe via PROFIBUS DP and PROFINET IO for all UCS..B safety modules – Can be extended by input/output modules <ul style="list-style-type: none"> - Up to 150 digital inputs/outputs - Up to 54 outputs
Areas of application	<ul style="list-style-type: none"> – Scara robots – Application storage/retrieval systems – Handling gantries – Special machine design – Palletizers

11.3 Decentralized installation

safetyDRIVE: Functional safety



Decentralized installation with a decentralized MOVIFIT® MC or FC and integrated function safety

Features and advantages

- Comprehensive safety functionality for disconnection, speed and direction of rotation monitoring (STO, SS1, SLS, SDI)
- Reduced wiring work through the integration of functional safety technology
- Short total response times of the application due to direct monitoring and disconnection
- Fast startup with simple parameterization of complete safety functions
- Easy and guided validation of safety functions
- Stand-alone safety solutions in independent operation without external safety controller possible
- Long product life of the safety components due to long service life (20 years)
- Easy integration of safe drive technology in existing plants with PROFIsafe communication
- Universal application in a PROFIsafe network via PROFIBUS and PROFINET IO via S12 safety option
- Certified according to EN ISO 13849-1 PL d

S12 safety option

- Control via PROFIsafe with S12 safety option
- Safety functions according to IEC 61800-5-2
 - Safe Torque Off (STO)
 - Safe stopping (SS1(c) and SS1(a))
 - Safe motion (SLS, SDI)
- Approvals
 - Up to SIL 3 according to IEC 61508
 - Up to PL e according to EN ISO 13849-1
- S12A variant
 - 4 safe inputs F-DI (OSSD-capable)
 - 2 pulse outputs
 - 2 safe outputs F-DO (2-pole)
 - 1 safe output, internal, STO (2-pole)
- S12B variant
 - 8 safe inputs F-DI (OSSD-capable)
 - 2 pulse outputs
 - 1 safe output, internal, STO (2-pole)

Application examples

- Roller conveyors
- Accumulating conveyors
- Corner transfer units
- Transfer units
- etc.



MOVISAFE® HM31 decentralized safety controllers can be used
with **MOVIPRO®**

<p>Features and advantages</p>	<ul style="list-style-type: none"> – Scalable safety technology for decentralized application inverters for simple and complex safety functions – Reduced wiring work through the integration of functional safety technology – Short total response times of the application due to direct monitoring and disconnection – Very easy startup and acceptance of axis safety functions – Flexible configuration and acceptance of complex, application-specific safety functions – Stand-alone safety solutions in independent operation without external safety controller possible – Long product life of the safety components due to long service life (20 years) – Easy integration of safe drive technology in existing plants with PROFIsafe communication – Universal application in a PROFIsafe network via PROFIBUS and PROFINET IO – Certified to (IEC 61508) SIL 3, (EN ISO 13849-1) PL e
<p>Simple project planning with MOVIPRO® SDC / ADC</p>	<ul style="list-style-type: none"> – Control via PROFIsafe with PROFIsafe option S11 – Optional, safety-related brake disconnection (SBC) – The integrated PROFIsafe option S11 comes equipped with four safety-related inputs for connecting safe sensors and two safety-related outputs
<p>Specific MOVIPRO® design with expanded functions as drive and system controller for MAXOLUTION® system solutions</p>	<ul style="list-style-type: none"> – MOVISAFE® HM31 decentralized safety controller – Free programming according to IEC 61131-3 per "drag & drop" using certified function blocks (Motion Library PFF-HM31) and the "SILworX" engineering tool – Ready-to-use drive and application modules (Motion Library, SIL 3 or PL e certified) are available based on IEC 61800-5-2 for mobile and stationary materials handling technology <ul style="list-style-type: none"> - SS1, SS2, SOS, SDI, SLS, SSR, SLA, SAR, SSM, SLI, SLP - Safe disconnection and stopping - Safe range changeover - Safe movement and position detection Hardware assignment <ul style="list-style-type: none"> – 24 safe digital inputs (8 OSSD-capable) and 8 safe sinking/sourcing digital outputs – Safe counter inputs (HTL, TTL) – CAN and RS485 interfaces Certification <ul style="list-style-type: none"> – SIL 3 according to IEC 61508 – PL e according to EN ISO 13849-1 Safe communication <ul style="list-style-type: none"> – safeethernet (SIL 3, master & slave), also possible via WLAN – PROFINET, PROFIsafe (controller/host & device/device)
<p>Application examples</p>	<p>Electrified monorail systems for heavy loads, automated guided vehicle systems, scissor lift tables, lifting/lowering conveyors, lifting stations, transfer carriages, rotary feeders, rotary indexing tables, high-speed horizontal conveyors with positioning</p>

11.4 Motor options

safetyDRIVE: Integrated safety technology

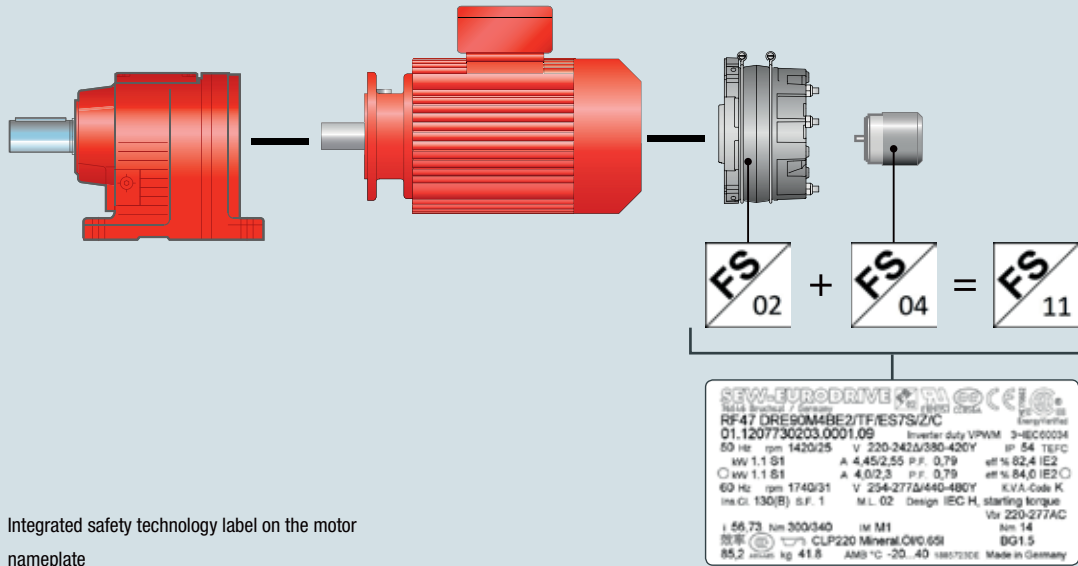



Integrated safety technology label on the motor nameplate

Features and advantages

Drives from SEW-EURODRIVE are equipped with integrated safety technology as an option. Encoders or brakes can be integrated in the drive as safety-related components either individually or in combination. SEW-EURODRIVE indicates the safety technology integrated in the drive via the FS logo on the motor nameplate. This way, you can recognize the use of safety technology at one glance during inspection and maintenance work and can react appropriately. This helps to ensure that the functional safety features remain valid in the future as well. Our functionally safe drive components are enhanced continuously and for this reason we are able to provide the entire safety system for your plants.

Integrated safety technology

	<p>Certified safety brake</p>
	<p>Certified safety encoder</p>
	<p>Combination of certified safety brake and certified safety encoder</p>

Integrated safety technology for DR../EDR.. AC motors



Certified safety encoders

Add-on encoders

Features	Our add-on encoders are available in functional safety design as an option. In combination with our safety modules such as UCS..B or DCS..B, comprehensive safety functions are available for monitoring motion and positions.
Advantages	<ul style="list-style-type: none"> – Use of a functionally safe encoder – Safety assessment of the encoder mounting according to EN ISO 13849-1 – Fulfillment of the requirements regarding documentation – High production quality for the higher requirements in functional safety areas – Indication of the characteristic safety values for easily determining the reached performance level – TÜV-certified for suitability of the encoders in safety-relevant applications – Also available for explosion-proof AC motors EDR.. / EDRN according to EU directive 2014/34/EU (ATEX) for types /3G, /3D, /3GD – Also available for explosion-proof AC motors EDRN.. according to IECEx for types /3G-c, /3D-c, /3GD-c
Designs	<p>For motor types DR..71 to DR..132 / DRN80 to DRN132S as well as for explosion-proof motor types EDR..71 to EDR..132 / EDRN80 to EDRN132S</p> <ul style="list-style-type: none"> – ES7S: safe sin/cos interface – AS7W: RS485 interface (multi-turn) + safe sin/cos interface – AS7Y: SSI interface (multi-turn) + safe sin/cos interface <p>For motor types DR..160 to DR..280 / DRN132M to DRN280 as well as for explosion-proof motor types EDR..160 to EDR..280 / EDRN132M to EDRN280</p> <ul style="list-style-type: none"> – EG7S: safe sin/cos interface – AG7W: RS485 interface (multi-turn) + safe sin/cos interface – AG7Y: SSI interface (multi-turn) + safe sin/cos interface
Classification/underlying standards	<ul style="list-style-type: none"> – SIL 2 according to EN 62061¹⁾ – PL d according to EN ISO 13849-1¹⁾
Safety functions according to IEC 61800-5-2	SS1, SS2, SOS, SLS, SDI, SLI, SLA, SSR, SSM

1) The SIL and PL classification applies to the sin/cos interface.

11.4 Motor options

Integrated safety technology for DR.. AC motors



Certified safety encoder

Built-in encoders

Features	Our built-in encoders are available in functional safety design as an option. In combination with our S12 safety option in MOVIFIT®, comprehensive safety functions are available for monitoring motion.
Advantages	<ul style="list-style-type: none"> – Use of a functionally safe encoder – Safety assessment of the encoder mounting according to EN ISO 13849-1 – Fulfillment of the requirements regarding documentation – High production quality for the higher requirements in functional safety areas – Indication of the characteristic safety values for easily determining the reached performance level – TÜV-certified for suitability of the encoders in safety-relevant applications
Designs	For motor types DR..71 to DR..132 / DRN80 to DRN132S EI7C FS: HTL interface (push-pull)
Classification/underlying standards	<ul style="list-style-type: none"> – SIL 2 according to EN 61800-5-2 – PL d according to EN ISO 13849-1
Safety functions according to IEC 61800-5-2	SS1, SLS, SDI



Certified safety brake

BE.. (single) brake

Features	<p>Safety brakes from SEW-EURODRIVE allow you to increase the safety in your machines by implementing safety functions for deceleration and stopping.</p> <p>The safety brake represents the safety-relevant actuator in the intelligent interaction of sensor, control and actuator.</p>
Advantages	<ul style="list-style-type: none"> – High production quality for the higher requirements in functional safety areas – Long operating time (T_{100} value) of the brake due to the high B_{100} values – High B_{100} values allow for a higher performance level – TÜV-certified for suitability of the brake in safety-relevant applications – Suited for integration into a safe brake system (SBS) up to performance level e (PL e)
Designs	<p>For motor types DR..71 to DR..225 / DRN63 to DRN225 as well as for explosion-proof motor types EDR..71 to EDR..225 / EDRN80 to EDRN225</p> <p>BE03 to BE32</p>
Nominal braking torques	0.9 Nm to 600 Nm
Options	<ul style="list-style-type: none"> – Manual brake release HR, automatic disengaging function – Function and wear monitoring DUB / DUE
Classification/underlying standards	Category 1 (cat. 1) according to EN ISO 13849-1
Safety functions	<ul style="list-style-type: none"> – SBA¹⁾ (Safe Brake Actuation): Safe brake actuation with the electromechanical brake – SBH¹⁾ (Safe Brake Hold): Safe brake hold with the electromechanical brake

¹⁾ Safety functions SBA and SBH were defined by SEW-EURODRIVE in accordance with the standard EN 61800-5-2.

11.4 Motor options

Integrated safety technology for DR.. AC motors



Certified safety brake

BF../BT.. double brake

Features	<p>Safety brakes from SEW-EURODRIVE allow you to increase the safety in your machines by implementing safety functions for deceleration and stopping.</p> <p>The safety brake represents the safety-relevant actuator in the intelligent interaction of sensor, control and actuator.</p>
Advantages	<ul style="list-style-type: none"> – High production quality for the higher requirements in functional safety areas – Long operating time (T_{100} value) of the brake due to the high B_{100} values – High B_{100} values allow for a higher performance level – TÜV-certified for suitability of the brake in safety-relevant applications – Suited for integration into a safe brake system (SBS) up to performance level e (PL e) <p>Further advantages of the BT11 to BT30 double brakes for applications in the entertainment technology sector</p> <ul style="list-style-type: none"> – Fulfillment of the specific requirements of entertainment technology (DIN 56950-1) – Extremely low-noise design for noise-sensitive environments
Designs	<p>For motor types DR..112 to DR..180</p> <ul style="list-style-type: none"> – For industrial applications: BF11 to BF30 – For applications in the entertainment technology sector: BT11 to BT30
Nominal braking torques	2 × 20 Nm to 2 × 300 Nm
Options	<ul style="list-style-type: none"> – Manual brake release HR, automatic disengaging function. The two partial brakes can be released simultaneously with a lever – Manual brake release HT, automatic disengaging function. The two partial brakes can be released simultaneously or separately with a lever – Continuous function and wear monitoring DUE
Classification/underlying standards	Category 3 ¹⁾ (cat. 3) according to EN ISO 13849-1
Safety functions	<ul style="list-style-type: none"> – SBA²⁾ (Safe Brake Actuation): Safe brake actuation with the electromechanical brake – SBH²⁾ (Safe Brake Hold): Safe brake hold with the electromechanical brake

¹⁾ According to the standard, category 3 requires brake diagnostics of the double brake. This is not part of the double brake and must be realized within the braking system.

²⁾ Safety functions SBA and SBH were defined by SEW-EURODRIVE in accordance with the standard EN 61800-5-2.

Integrated safety technology for CMP.. servomotors



Certified safety encoders

Features	Our encoders are available in functional safety design as an option. In combination with our safety modules such as UCS..B or DCS..B, comprehensive safety functions are available for monitoring motion and positions.
Advantages	<ul style="list-style-type: none"> – Use of a functionally safe encoder – Safety assessment of the encoder mounting according to EN ISO 13849-1 – Fulfillment of the requirements regarding documentation – High production quality for the higher requirements in functional safety areas – Indication of the characteristic safety values for easily determining the reached performance level – TÜV-certified for suitability of the encoders in safety-relevant applications
Designs	<p>For motor types CMP.40 to CMP.112S/M AKOH: RS485 interface (HIPERFACE® multi-turn) + safe sin/cos interface</p> <p>For motor types CMP.50 to CMP.112 AK1H: RS485 interface (HIPERFACE® multi-turn) + safe sin/cos interface</p>
Classification/underlying standards	<ul style="list-style-type: none"> – SIL 2 according to EN 62061¹⁾ – PL d according to EN ISO 13849-1¹⁾
Safety functions according to IEC 61800-5-2	SS1, SS2, SOS, SLS, SDI, SLI, SLA, SSR, SSM

1) The SIL and PL classification applies to the sin/cos interface.

11.4 Motor options

Integrated safety technology for CMPZ.. servomotors



Certified safety brake
BY.. (single) brake

Features	Safety brakes from SEW-EURODRIVE allow you to increase the safety in your machines by implementing safety functions for deceleration and stopping. The safety brake represents the safety-relevant actuator in the intelligent interaction of sensor, control and actuator.
Advantages	<ul style="list-style-type: none"> – High production quality for the higher requirements in functional safety areas – Long operating time (T_{100} value) of the brake due to the high B_{100} values – High B_{100} values allow for a higher performance level – TÜV-certified for suitability of the brake in safety-relevant applications – Suited for integration into a safe brake system (SBS) up to performance level e (PL e)
Design	For motor types CMPZ71 to CMPZ100 BY2 to BY8
Nominal braking torques	7 Nm to 80 Nm
Option	Manual brake release HR, automatic disengaging function
Classification/underlying standards	Category 1 (cat. 1) according to EN ISO 13849-1
Safety functions	<ul style="list-style-type: none"> – SBA¹⁾ (Safe Brake Actuation): Safe brake actuation with the electromechanical brake – SBH¹⁾ (Safe Brake Hold): Safe brake hold with the electromechanical brake

¹⁾ Safety functions SBA and SBH were defined by SEW-EURODRIVE in accordance with the standard EN 61800-5-2.

11.5 Safe brake control

safetyDRIVE: BST safe brake module



BST safe brake module for control cabinet installation

Features	<p>Brake control for safe disconnection of a brake.</p> <p>The two DC 24 V control inputs of the safe BST brake module allow for controlling the brake in a device to control the brake in a functional and safety-related manner.</p>
Advantages	<ul style="list-style-type: none"> – Simple installation in the control cabinet on the mounting rail – Suited for safe switching of our brakes – The BST as electronic switching element achieves: <ul style="list-style-type: none"> - Wear-free switching off of the brake in normal operation as well as in emergency stop braking operations - Elimination of the consideration of permitted operating cycles, such as for relays - Elimination of the contact monitoring (feedback) in the higher-level safe logic, e.g. for relays - Elimination of the $MTTF_0$ calculation due to the confirmation of the characteristic safety value from SEW-EURODRIVE – Status display of the switching state of the brake control directly at the BST – TÜV-certified for suitability of the brake in safety-relevant applications
Voltage supply	BST is supplied via the DC link of the inverter, for example
Brake voltage	<p>Available for brake voltages</p> <ul style="list-style-type: none"> – 230 V – 400 V – 460 V
Brakes	<ul style="list-style-type: none"> – Suited for brakes with 2-wire and 3-wire connection ≤ 120 W – Compatible brakes at the DR.. asynchronous motor <ul style="list-style-type: none"> - BE03 to BE32 - BF11 to BF30 – Compatible brakes at the CMP.. synchronous motor <ul style="list-style-type: none"> - BY2 to BY14
Classification/underlying standards	Category 3 (cat. 3), PL d according to EN ISO 13849-1
Safety function according to IEC 61800-5-2	Safe Brake Control (SBC)

11.6 Brake diagnostics

Brake diagnostics software function



Brake diagnostics software function

Features	For checking the proper functioning and performance of your brakes.
Advantages	<ul style="list-style-type: none"> – Easy startup thanks to our standardized software function for controllers – Function expansion for your MOVIDRIVE® B application inverter or your MOVIAXIS® multi-axis servo inverter – Evaluation of your safety system through the diagnostic coverage of the brake diagnostics (DCavg value) – Fulfillment of normative requirements for your safety system allows solutions up to performance level e (PL e) – Increase of the system availability by detecting functional or performance limits very early as well as optimization of maintenance work
Static brake diagnostics	<ul style="list-style-type: none"> – Diagnoses your brake by checking the switching capability and the existing braking torque – Separate diagnostics for each brake – Diagnostics is wear-free for the brake – The integrated dynamic load recognition automatically recognizes the current load situation. A separate test load is no longer necessary for diagnostics.
Dynamic brake diagnostics	<ul style="list-style-type: none"> – Checks the permitted stopping distance – Supplements the static brake diagnostics

11.7 Safety Configuration Library (SCL®)



Safety Configuration Library (SCL®)

The Safety Configuration Library (SCL®) facilitates the selection of SEW-EURODRIVE drive technology components for functional safety technology. Using the navigation, you can conveniently select/configure your required safety concept. With each selection, a corresponding conceptual drawing is generated. This drawing is greatly simplified and provides an overview of the essential components. At the end of the configuration you will obtain a complete conceptual drawing and an overview of the safety functions that can be implemented. This conceptual drawing can be downloaded and saved as a PDF file. Our conceptual drawings have been certified by TÜV SÜD.

Features



Available in three languages

The Safety Configuration Library (SCL®) is available in three languages.

Start the SCL® online at:

- English: <http://scl.sew-eurodrive.com>
- German: <http://scl.sew-eurodrive.de>
- French: <http://scl.usocome.com>

12

ENERGY TRANSFER / POWER SUPPLY

12.1	MOVITRANS® contactless energy transfer system	342
12.2	MOVI-DPS® decentralized power supply	346



12.1 MOVITRANS® contactless energy transfer system



Features	<ul style="list-style-type: none"> – MOVITRANS®, the contactless energy transfer system from SEW-EURODRIVE, works on the principle of inductive energy transfer – Electrical energy is transferred without contact from a fixed conductor to one or more mobile consumers – The electromagnetic connection is made via an air gap and is not subject to wear; it is therefore maintenance-free – Contactless energy transfer is emission-free and resistant to contamination from external sources – Tested according to BGV B11
Areas of application	<ul style="list-style-type: none"> – Perfect supply system for all mobile applications – Long distances are covered at high speed – When maintenance-free operation is required – When additional environmental contaminants are not permitted in sensitive areas – In wet and humid areas
Stationary components	
TPS stationary converter	<ul style="list-style-type: none"> – Power: 4.0 kW or 16.0 kW – V_{line}: 380 V – 500 V ± 10% – Degree of protection: IP20
TAS transformer module	<ul style="list-style-type: none"> – Power: 4.0 kW or 16.0 kW – I_A: 60 A or 85 A – Degree of protection: IP10
TCS compensation capacitors	<ul style="list-style-type: none"> – Capacitance values: 2 μF, 4 μF, 8 μF, 16 μF or 32 μF – Output current: 60 A or 85 A – Degree of protection: IP00

Mobile components

TPM21B mobile converter	<ul style="list-style-type: none"> – Nominal output power: <ul style="list-style-type: none"> – When 4 THM10C units are connected: max. 3.6 kW – When 2 THM10E units are connected: max. 3.0 kW – Output voltage: DC 500 V – Additional output voltage: 24 V, max. 2 A – Degree of protection: IP65
THM10E pick-up	<ul style="list-style-type: none"> – Power: 1.5 kW – Degree of protection: IP65
THM10C pick-up	<ul style="list-style-type: none"> – Nominal power: 0.8 kW – Peak power: 0.9 kW – Degree of protection: IP65
TVS connection distributor	<ul style="list-style-type: none"> – Degree of protection: IP65 – Output current: 60 A or 85 A
TCS compensation box	<ul style="list-style-type: none"> – Degree of protection: IP65 – Output current: 60 A or 85 A – Compensates a travel distance of 25 to 30 m

12.1 MOVITRANS® contactless energy transfer system

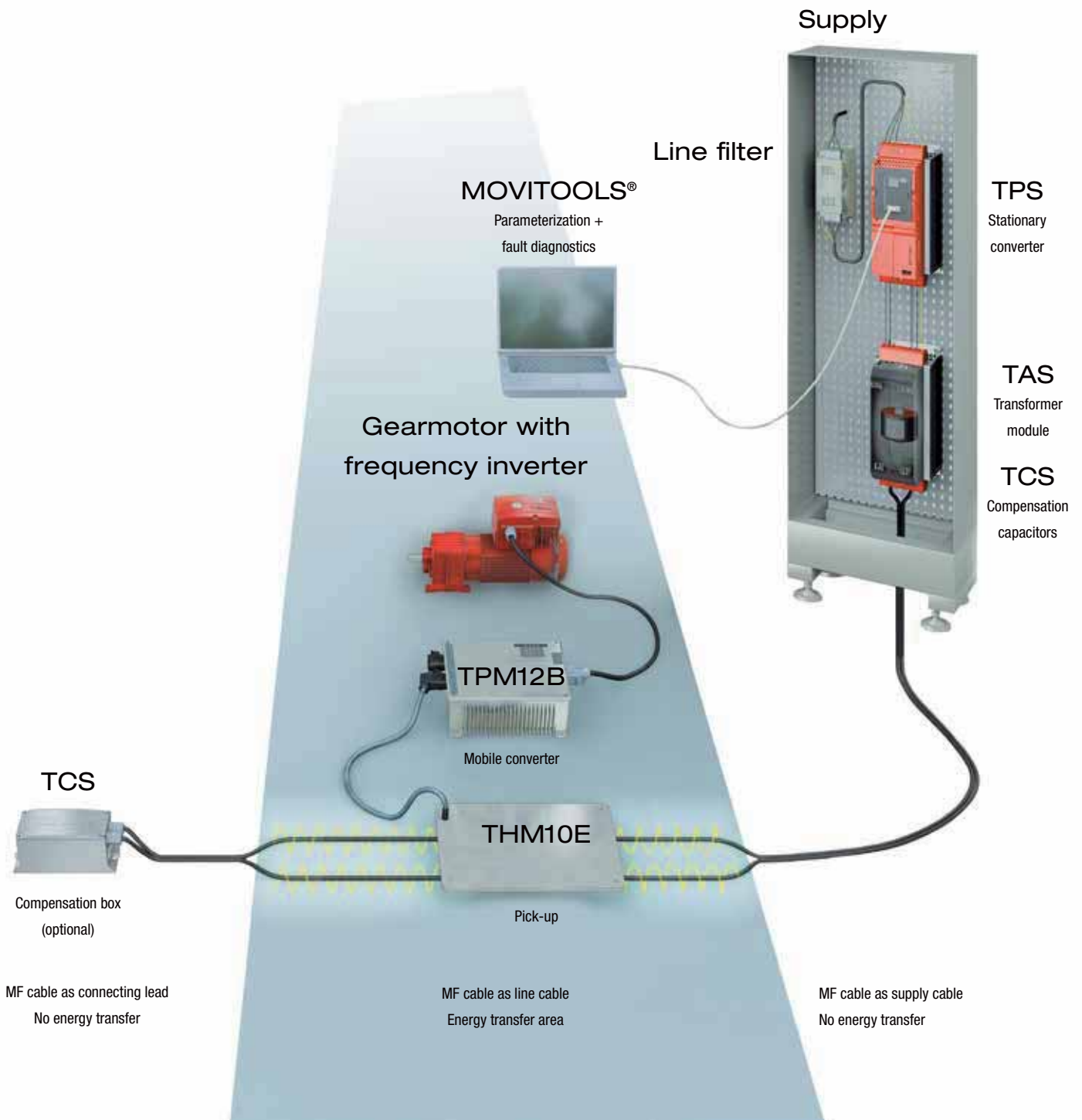

MOVITRANS® with flat pick-up (THM10E)

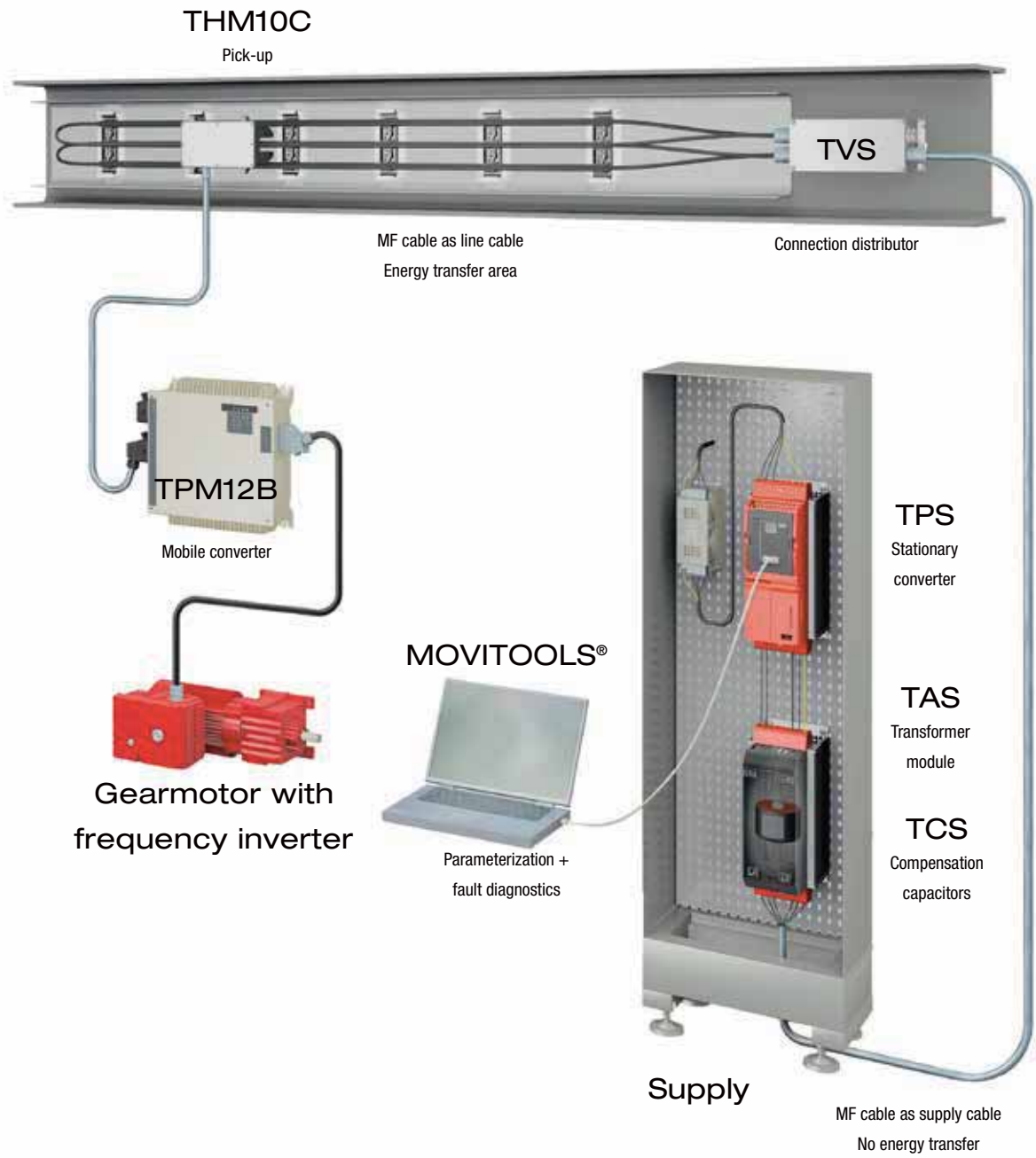

MOVITRANS® with U-shaped
pick-up (THM10C)

TIS
Installation components
for line cable routing



12.2 MOVI-DPS® decentralized power supply



	MOVI-DPS® in energy mode	MOVI-DPS® in power mode
Features	<p>In energy mode, MOVI-DPS® can supply applications with energy from the MOVI-DPS® storage bundle continuously over several minutes. For example, this allows for an automated guided vehicle (AGV) to leave the MOVITRANS® line cable and travel a section without external power supply.</p> <p>In addition, the peak power of the AGV can be increased with power supply via MOVITRANS®.</p>	<p>With MOVI-DPS® in power mode you can realize very dynamic applications with travel cycles of 1 – 60 seconds. The intelligent energy management significantly reduces the input power.</p>
Advantages	<ul style="list-style-type: none"> – Decentralized energy storage – Decentralized energy supply – Energy optimization of applications and systems – Reduction of overall operation costs – Reduction of costs for supply system infrastructure – Increase of the process reliability in case of power failure 	
Application options	<ul style="list-style-type: none"> – Reducing the peak loads taken from the supply system – Voltage stabilization – UPS function: <ul style="list-style-type: none"> - Fire protection applications - Storage/retrieval systems, handling devices - Maintaining the DC 24 V supply 	
Applications	<ul style="list-style-type: none"> – Automated guided vehicle systems (AGVS) – Electrified monorail systems (EMS) – Shuttles, satellites for small-parts or pallet warehouses – Storage and retrieval systems – Vertical conveyors – Pallet transfer shuttle – Lifting conveyors 	

Component overview

The MOVI-DPS® components are compatible with the current standard components from SEW-EURODRIVE. This way you receive all modules for your application from one source – and only have one contact person.

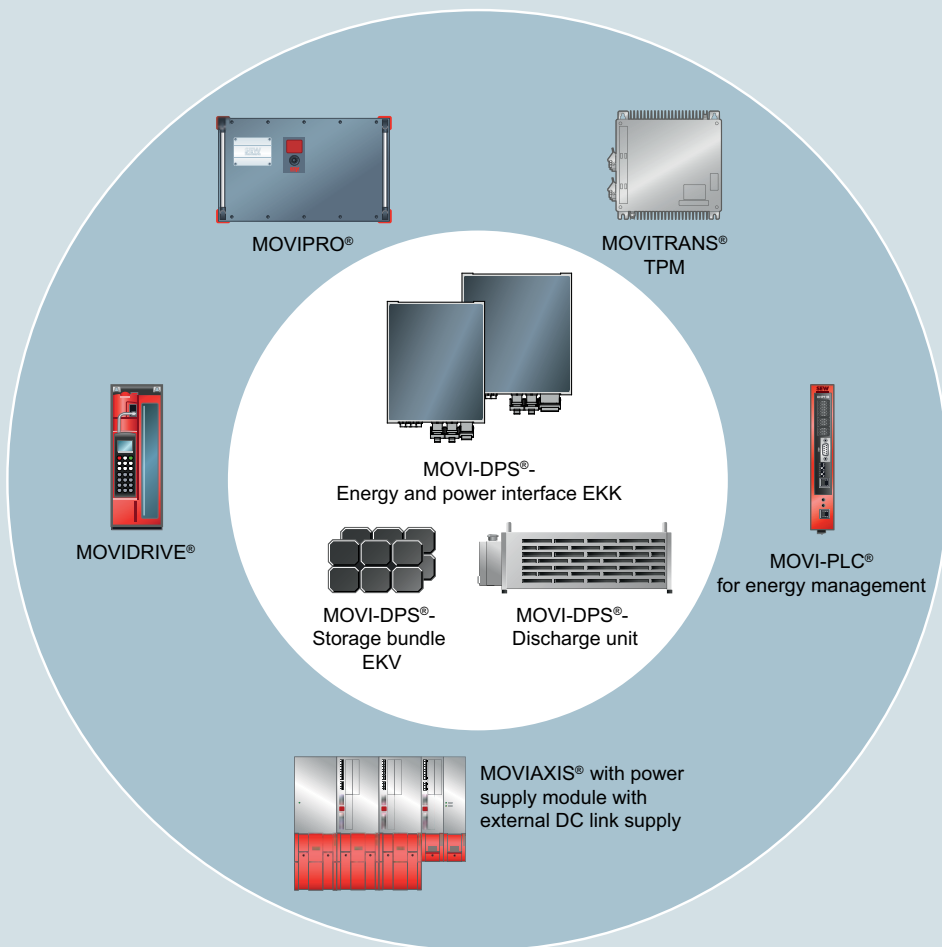

12.2 MOVI-DPS® decentralized power supply

Energy mode

Load

The MOVI-DPS® storage bundle is loaded from the supply system.

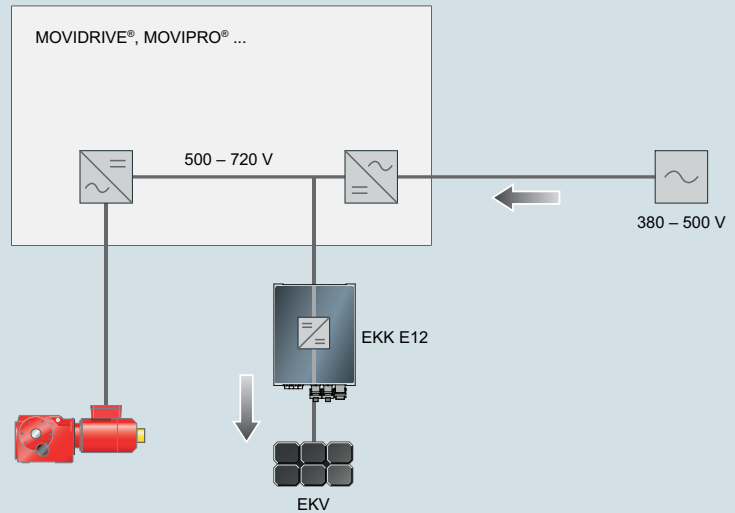

Travel

The storage bundle takes over the power supply for a defined time frame in case there is no supply system.

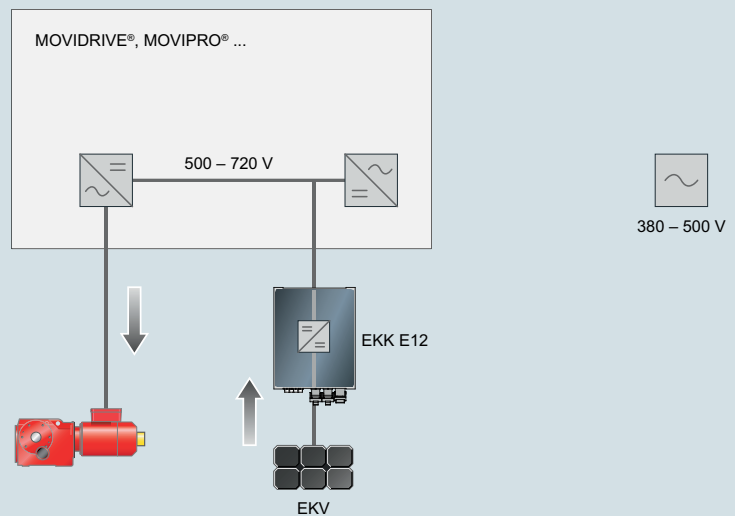

Brake

The storage bundle saves the regenerative energy during braking.

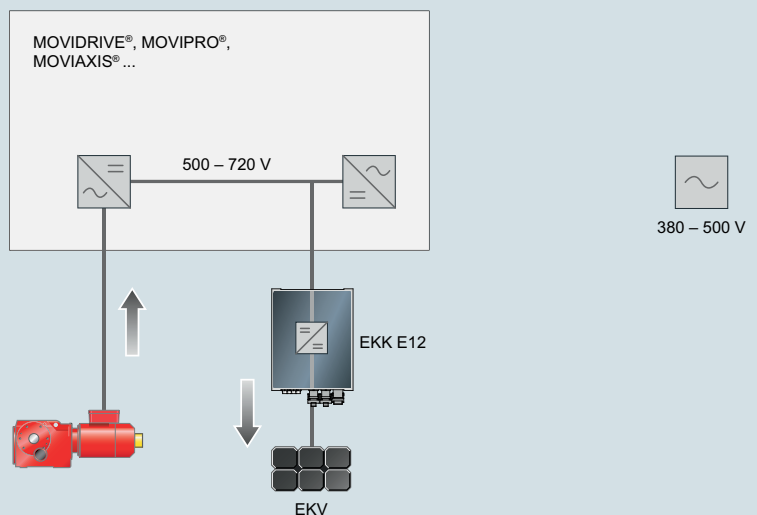

Power mode

Accelerate

The peak load for the acceleration procedure is fully provided from the storage bundle. Only the losses due to the system efficiency are taken from the supply system. This way, energy consumption from the supply system is limited and the grid load is considerably reduced.

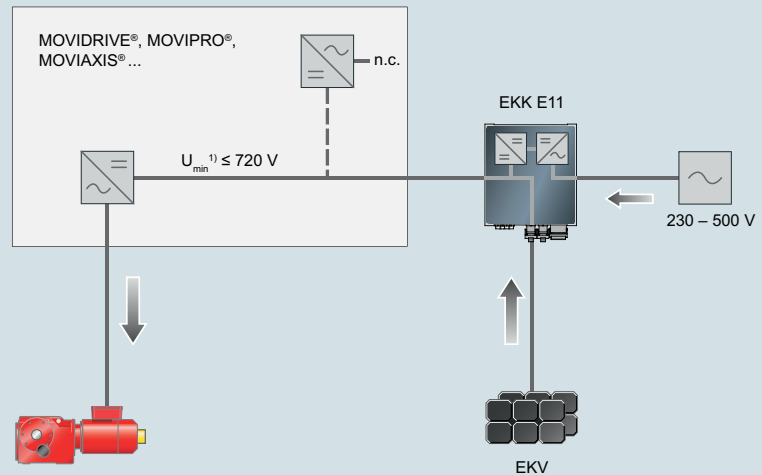

¹⁾ Depends on application configuration

Travel

During constant travel, the required nominal power for balancing the system losses are taken from the supply system. In addition, it would be possible to load the storage bundle through the supply system.

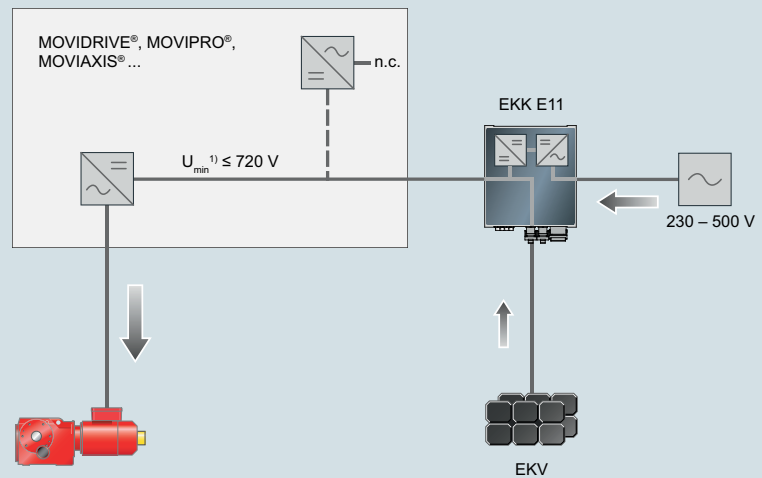

¹⁾ Depends on application configuration

Brakes

The regenerative energy is stored directly in the storage bundle and is thus available for the application again. At the same time, heat transmission by the braking resistor that is no longer necessary is avoided. In addition, the supply system is not strained by the additional reactive power and harmonics.

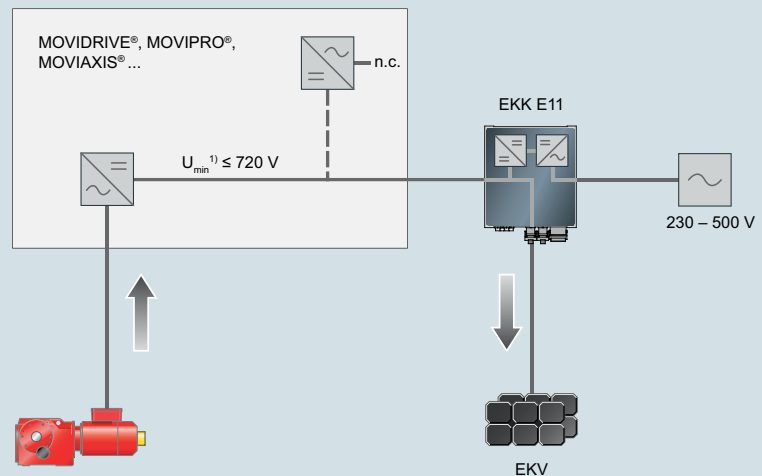

¹⁾ Depends on application configuration

13 DIDACTICS MODULES

13.1 Electromechanics	352
13.2 Gear unit technology	356
13.3 Systems	361
13.4 Documentation	364
13.5 Connection leads (cables)	367

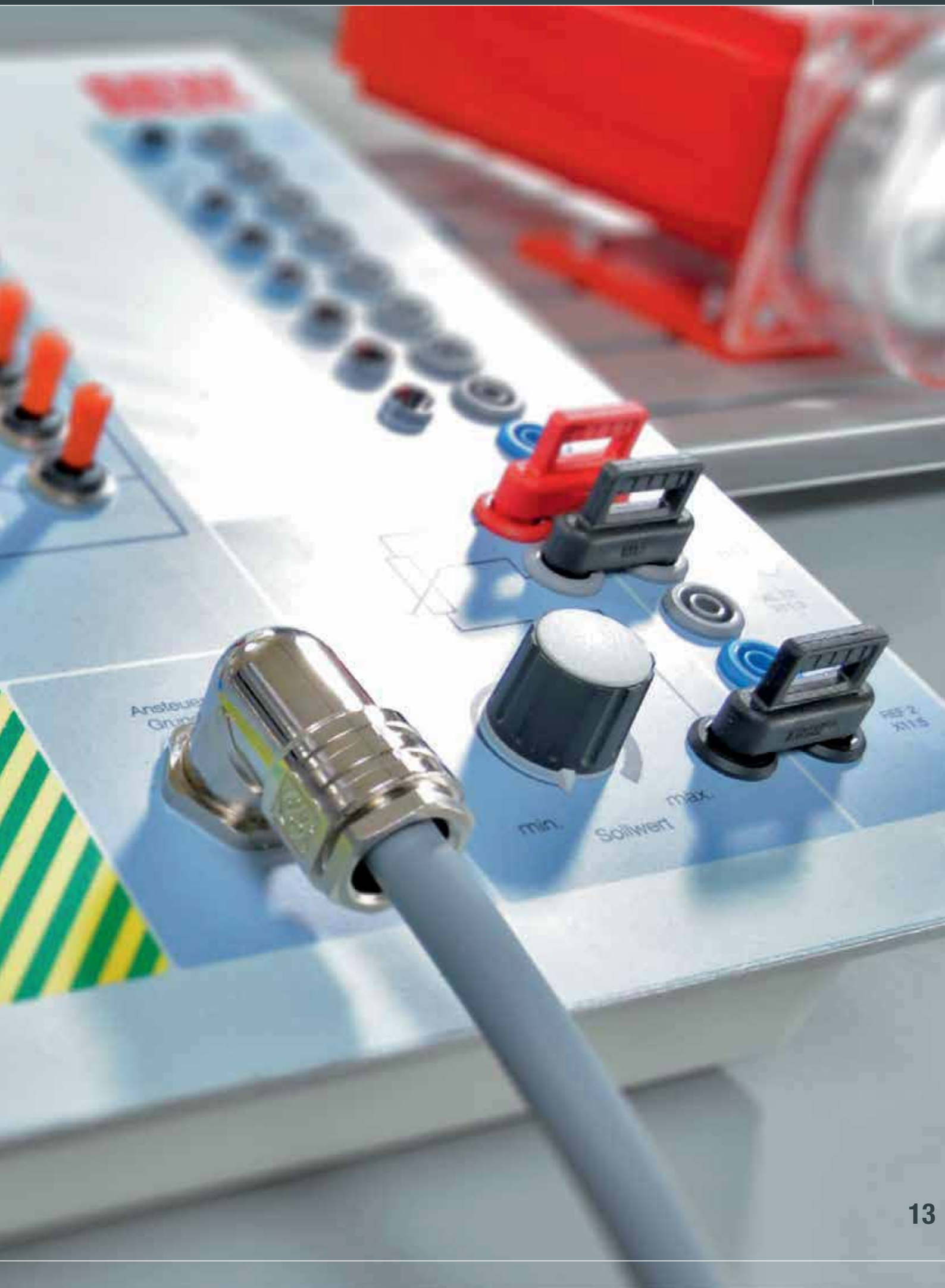

13.1 Didactics modules for electromechanics

Electromechanics – easy to understand and safe



Electromechanics

Subject area 8: Selecting and integrating drives, perfect for all trainings regarding electromechanics and mechatronics

The modular didactics concept Electromechanics was especially designed for the learning field-oriented training in drive technology for electronics engineers. It combines practical exercises for the operation of AC motors at the supply system and with frequency inverters. Further, the modular demo unit concept allows for flexible education and training of specialists. For example, a master-slave situation with known functions (speed control, direction control, measuring functions) can be simulated with a higher-level PLC.

Modules

(Didactics product series electromechanics)

- MOVIDRIVE® B module (MDX) drive inverters
- MOVITRAC® B module (MCB) frequency inverters
- MOVI4R-U® module (M4U) frequency inverters
- Brake control module (BMK)
- Brake control module (BMV)
- DRS.. motor assembly
- DRS.. brakemotor assembly
- CMP.. motor assembly
- CMP.. brakemotor assembly
- Motor load brake module (MLB)
- Motor circuit breaker module (MSS)
- Reversing contactor switch module (WSS)
- Star/delta switchover module (SDU)
- Motor load diagnostics module (MLD)

Advantages

- Flexible and modular test setup
- Easy integration possibilities in existing laboratory concepts
- Realistic measurements of electric and mechanical values
- Industry standard, safe and reproducible
- Demo unit panels (modules) are compatible with the educational concepts of other manufacturers of teaching materials
- All demo units/system cases are optionally available for easy transportation and storage



MOVIDRIVE® B module (MDX) drive inverters

Design

- Line voltage 3x 400 V
- Control via digital and analog signals
- Optional control via PROFIBUS or PROFINET
- Braking resistor connection routed outside
- Available with application inverter in size 0M or 1
- Easy introduction to safety functions such as STO
- Suitable for AC asynchronous motors and AC synchronous motors (synchronous servomotors)
- Acoustic protection cover monitoring in combination with MLB



MOVITRAC® B module (MCB) frequency inverters

Design

- Line voltage 1x 230 V or 3x 400 V
- Control via digital and analog signals
- Optional control via PROFIBUS or PROFINET
- Braking resistor connection routed outside
- Suitable for AC asynchronous motors
- Acoustic protection cover monitoring in combination with MLB



MOVI4R-U® module (M4U) frequency inverters

Design

- Line voltage 1x 230 V
- Easy and fast startup and parameterization
- Very robust due to aluminum housing
- Control via digital and analog signals
- Suitable for AC asynchronous motors

13.1 Didactics modules for electromechanics

Electromechanics – easy to understand and safe



Brake control module (BMK)

Design

- Matches DRS.. brakemotor assembly
- Brake control (BMKB 1.5)
- One-way rectifier with electr. switching
- DC 24 V control input
- Separation on DC side with LED ready for operation display
- 3-step rotary switch



Brake control module (BMV)

Design

- Matches CMP.. brakemotor assembly
- Brake control (BMV 5)
- Brake control unit with electronic switching function
- DC 24 V control input
- External DC 24 V required for brake voltage
- 3-step rotary switch



Motor load brake module (MLB)

Design

- AC asynchronous motor type DRS71S4
 - Nominal power 0.37 kW
 - Voltage 230 V / 400 V
 - Insulation class F
- Temperature sensor
- EI7C built-in encoder
- Acoustic protection cover monitoring in combination with MCB, MDX or MTF



DRS.. motor assembly

Design

- DRS71S4 AC asynchronous motor
- Nominal power 0.37 kW
- Voltage 230 V / 400 V
- Insulation class F
- Temperature sensor
- EI7C built-in encoder (optional)
- Various add-on encoders (optional)
- Stands securely due to aluminum plate with rubber base
- Easy and safe handling
- Aluminum flywheel with cover



DRS.. brakemotor assembly

Design

- DRS71S4BE.. AC asynchronous motor
- Nominal power 0.37 kW
- Voltage 230 V / 400 V
- Insulation class F
- Temperature sensor
- Brake voltage 400 V
- Braking torque 5 Nm
- EI7C built-in encoder (optional)
- Various add-on encoders (optional)
- Stands securely due to aluminum plate with rubber base
- Easy and safe handling
- Aluminum flywheel with cover



CMP.. motor assembly

Design

- CMP50M AC synchronous motor
- Nominal torque 2.4 Nm
- Voltage 400 V
- Max. current 9.6 A
- Insulation class F
- Temperature sensor
- Single-turn EK1H HIPERFACE® encoder
- Stands securely due to aluminum plate with rubber base
- Easy and safe handling
- Aluminum flywheel with cover

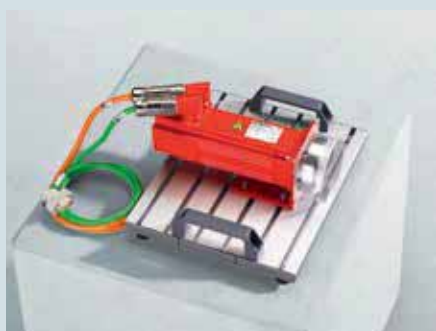

CMP.. brakemotor assembly

Design

- AC synchronous motor with brake (servomotor), type CMP50M/BK
- Nominal torque 2.4 Nm
- Voltage 400 V
- Max. current 9.6 A
- Insulation class F
- Temperature sensor
- Brake voltage 24 V
- Braking torque 4.3 Nm
- Stands securely due to aluminum plate with rubber base
- Easy and safe handling
- Aluminum flywheel with cover

13.2 Didactics modules for gear unit technology

Gear units – modular and practical



Helical, helical-bevel, and helical-worm gear units

NEW: Planetary gear unit

Ideal for all trainings for employees working with metal, for mechatronics technicians and industrial mechanics for subject area 10 – Gear unit technology.

A standard helical gear unit, a helical-bevel gear unit and a helical-worm gear unit were adapted especially for this didactic purpose. This allows for easy assembly and disassembly of different gear unit parts without expensive pressing tools.

Advantages

- All components have corrosion protection
- Gear units can be easily assembled and disassembled (reproducible and wear-free)
- Clear presentation of all components and tools (short preparation and follow-up times)
- Industrial tool for retaining rings and screws optionally available
- Board with wheels (optional) for easy transportation



R57FAD2 helical gear unit

Features

- Gear unit with 2 or 3 stages
- Illustrated assembly instructions enclosed
- Safe assembly and disassembly of the machine elements without pressing tools
- Stands securely due to foot/flange-mounted design
- Function test with handwheel
- Close-to-production design
- Clearly structured and integrated in robust plastic cases

Gear ratio (in theory)

- $i = 16.79$ (2 stages)
- $i = 26.97$ (3 stages)



K47AD2 helical-bevel gear unit

Features

- Setting the gear backlash and bearing clearance of the bevel gear and the bevel pinion
- Illustrated assembly instructions enclosed
- Safe assembly and disassembly of the machine elements without pressing tools
- Stands securely due to foot-mounted design
- Function test with handwheel
- Close-to-production design
- Clearly structured and integrated in robust plastic cases

Gear ratio (in theory)

- $i = 35.39$ (3 stages)



SF47AD2 helical-worm gear unit

Features

- Setting the gear backlash and bearing clearance of the worm gear and the worm
- Illustrated assembly instructions enclosed
- Safe assembly and disassembly of the machine elements without pressing tools
- Secure position due to foot/flange-mounted design
- Function test with handwheel
- Close-to-production design
- Clearly structured and integrated in robust plastic cases

Gear ratio (in theory)

- $i = 29$ (2 stages)

13.2 Didactics modules for gear unit technology

Gear units – modular and practical



Planetary gear unit

Features

- Gear unit with 1 or 2 stages
- Illustrated assembly instructions enclosed
- Safe assembly and disassembly of the machine elements without pressing tools
- Stands securely due to aluminum plate and mounting bracket
- Function test with handwheel
- Close-to-production design
- Clearly structured and integrated in robust plastic cases

Gear ratio (in theory)

- $i = 5$ (1 stages)
- $i = 25$ (2 stages)



R57FAD2 helical gear unit demo cabinet

Features

- Gear unit with 2 or 3 stages
- Illustrated assembly instructions enclosed
- Safe assembly and disassembly of the machine elements without pressing tools
- Stands securely due to foot/flange-mounted design
- Function test with handwheel
- Close-to-production design
- All components such as tools and gear unit parts are clearly structured and integrated in foam inlays in the lockable assembly trolley
- Available with different table heights

Gear ratio (in theory)

- $i = 16.79$ (2 stages)
- $i = 26.97$ (3 stages)



K47AD2 helical-bevel gear unit demo cabinet

Features

- Setting the gear backlash and bearing clearance
- Illustrated assembly instructions enclosed
- Safe assembly and disassembly of the machine elements without pressing tools
- Stands securely due to foot-mounted design
- Function test with handwheel
- Close-to-production design
- All components such as tools and gear unit parts are clearly structured and integrated in foam inlays in the lockable assembly trolley
- Available with different table heights

Gear ratio (in theory)

- $i = 35.39$ (3 stages)



Helical-worm gear unit demo cabinet

Features

- Setting the gear backlash and bearing clearance
- Illustrated assembly instructions enclosed
- Safe assembly and disassembly of the machine elements without pressing tools
- Stands securely due to foot-mounted design
- Function test with handwheel
- All components such as tools and gear unit parts are clearly structured and integrated in foam inlays in the lockable assembly trolley
- Close-to-production design
- Available with different table heights

Gear ratio (in theory)

- $i = 29$ (2 stages)

13.2 Didactics modules for gear unit technology

Gear units – modular and practical



Planetary gear unit demo cabinet

Features

- Setting the gear backlash and bearing clearance
- Illustrated assembly instructions enclosed
- Safe assembly and disassembly of the machine elements without pressing tools
- Stands securely due to foot-mounted design
- Function test with handwheel
- All components such as tools and gear unit parts are clearly structured and integrated in foam inlays in the lockable assembly trolley
- Close-to-production design
- Available with different table heights

Gear ratio (in theory)

- $i = 5$ (1 stages)
- $i = 25$ (2 stages)

➔ All cut-away functional models are also available with DRS.. series AC motors (4 variants)

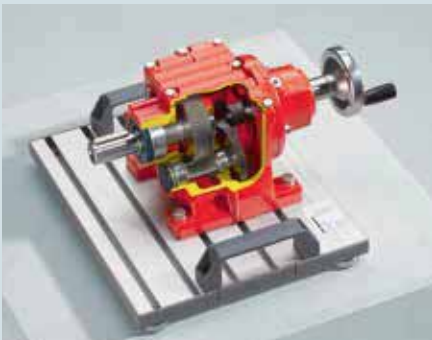

R27AD1 cut-away model helical gear unit

Features

- Shows the structure of a helical gearing in motion
- Stands securely due to aluminum plate with rubber base
- Easy transport
- Function test with handwheel
- Nameplate for easy gear unit calculations available
- Close-to-production design
- Gears, pinion shafts and shafts are protected against corrosion
- Plastic cases with foam inlays for safe storage (optional)

Gear ratio (in theory)

- $i = 90.96$ (3 stages)

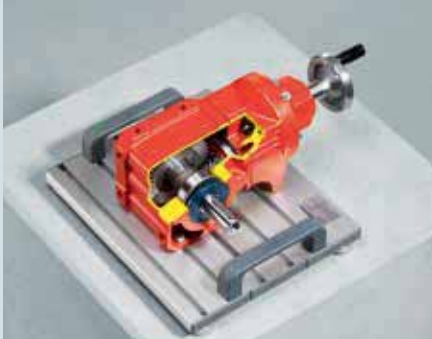

NEW: K29 cut-away model helical-bevel gear unit

Features

- Shows the structure of a bevel gearing in motion
- Stands securely due to aluminum plate with rubber base
- Easy transport
- Function test with handwheel
- Nameplate for easy gear unit calculations available
- Close-to-production design
- Gears, pinion shafts and shafts are protected against corrosion
- Plastic cases with foam inlays for safe storage (optional)

Gear ratio (in theory)

- $i = 19.99$ (2 stages)



K37AD1 cut-away model helical-bevel gear unit

Features

- Shows the structure of a bevel gearing in motion
- Stands securely due to aluminum plate with rubber base
- Easy transport
- Function test with handwheel
- Nameplate for easy gear unit calculations available
- Close-to-production design
- Gears, pinion shafts and shafts are protected against corrosion
- Plastic cases with foam inlays for safe storage (optional)

Gear ratio (in theory)

- $i = 97.81$ (3 stages)

→ All cut-away functional models are also available with DRS.. series AC motors (4 variants)

13.2 Didactics modules for gear unit technology

Gear units – modular and practical



S47AD1 cut-away model helical-worm gear unit

Features

- Shows the structure of a helical-worm gearing in motion
- Stands securely due to aluminum plate with rubber base
- Easy transport
- Function test with handwheel
- Nameplate for easy gear unit calculations available
- Close-to-production design
- Gears, pinion shafts and shafts are protected against corrosion
- Plastic cases with foam inlays for safe storage (optional)

Gear ratio (in theory)

$i = 29$ (2 stages)

→ All cut-away functional models are also available with DRS.. series AC motors (4 variants)

13.3 Systems



Multi-functional demo unit

Design

- Ideal concept for professional schools and for advanced vocational training
- Drives and power electronics are designed according to customer specifications and are delivered on a transportable aluminum frame
- Applications such as conveyor line, lifting axis can be equipped with different types of sensors, e.g. inductive, capacitive, limit switch with roller lever, etc.



MOVIGEAR® functional demo unit

Design

- Compact training concept and test stand for employees responsible for maintenance and startup
- All tools, prefabricated cables, operating box and handwheel are included in the delivery (handwheel for explaining the DynaStop® function)
- Line voltage 3x 400 V / 50 Hz
- Plastic cases with foam inlays for safe storage (optional)
- Board with wheels (optional) for easy transportation

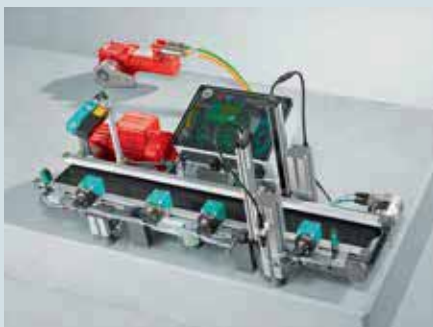

Didactics conveyor line

Design

- Easy and safe handling
- Possible to mount direct distance encoder
- Optional sensor technology
 - Inductive/capacitive proximity switches
- Position detection
 - RFID write and read head for product detection
 - Light barrier to detect height of product
 - Distance measurement
- Belt conveyor
- Alternative motor mounting
 - AC asynchronous motor (type WA10DT56L4)
 - Synchronous servomotor (type WA10CMP40M)

13.4 Documentation



- Quick start package
- R57F AD2 helical gear unit
- K47 AD2 helical-bevel gear unit

Content

- Part drawings
- Application clips
- Tasks
- Dimension sheets and spare parts lists
- Documentation
- CAD data



NEW: USB flash drive

Content

- Assembly instructions for each gear unit type on a USB flash drive
- Technical drawings
- Dimension sheets and spare parts lists
- Part drawings
- CAD file in STEP format
- Tasks
- Documentation
- Application clips



Exercise book

Technical calculation (edition for pupils/apprentices)

Features

- Exercise book, bound copy, printed in black/white
- Set of exercises on the basics of drive technology (AC asynchronous motor)
- Sample exercises e.g. on energy efficiency

Content of the exercises without solutions:

- Reading and understanding the nameplate of an asynchronous AC motor
- Calculating all the relevant parameters of an asynchronous AC motor
- Determining important characteristic data for setting a motor circuit breaker
- Drafting speed characteristics
- Reversing contactor switch and star/delta startup
- Calculating the energy consumption of a system



Exercise book

Technical calculation (edition for trainers/teachers)

Features

- Exercise book, bound copy, color print
- Set of exercises on the basics of drive technology (AC asynchronous motor) with correct answers
- Including a CD with a digital version of the exercises and solutions

Content of the exercises with solutions:

- Reading and understanding the nameplate of an asynchronous AC motor
- Calculating all the relevant parameters of an asynchronous AC motor
- Determining important characteristic data for setting a motor circuit breaker
- Drafting speed characteristics
- Reversing contactor switch and star/delta startup
- Calculating the energy consumption of a system

13.4 Documentation



Exercise book

Gear unit technology basics (edition for pupils/apprentices)

Features

- Exercise book, bound copy, color print
- Training documents on the introduction to gear unit technology incl. exercises

Content of the exercises without solutions:

- Fields of application for gear units
- Operating principle of various gear unit types, and types of gearing
- Various options of installation and mounting to applications
- Mounting positions
- Calculations of gear ratios of gear units
- Combinations of motors and gear units



NEW: Exercise book

Gear unit technology basics (edition for trainers/teachers)

Features

- Exercise book, bound copy, color print
- Training documents on the introduction to gear unit technology incl. exercises with solutions
- Including a CD with a digital version of the exercises and solutions

Content of the exercises with solutions:

- Fields of application for gear units
- Operating principle of various gear unit types, and types of gearing
- Various options of installation and mounting to applications
- Mounting positions
- Calculations of gear ratios of gear units
- Combinations of motors and gear units

13.5 Connection leads (cables)



Connection leads for didactics modules

Features

- Various connection leads and cables, matching the electromechanics didactics modules
- Shielded cables for EMC-compliant connections e.g. supply system cables 230 V / 400 V with 4 mm shrouded plugs
- Motor connection cables, optionally 4 mm shrouded plugs or standard industrial plugs
- Can be combined with different didactics modules and laboratory benches

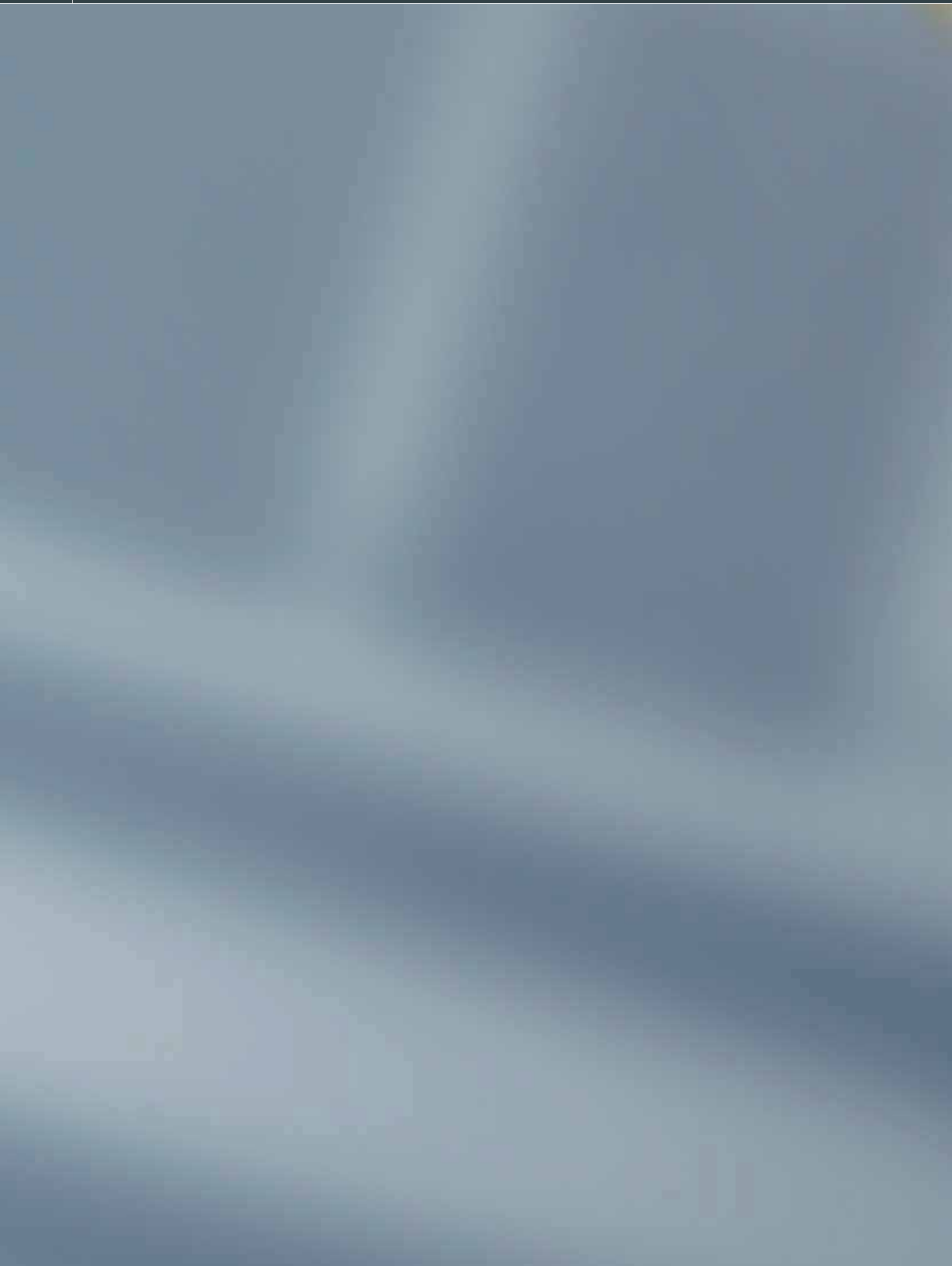



SEW-EURODRIVE is right there for you

AUGSBURG

Tel. 0821 22779-10
 Fax 0821 22779-50
 tb-augsburg@sew-eurodrive.de

BERLIN

Tel. 030 6331131-30
 Fax 030 6331131-36
 dc-berlin@sew-eurodrive.de

BODENSEE

Tel. 07544 96590-90
 Fax 07544 96590-99
 tb-bodensee@sew-eurodrive.de

BREMEN

Tel. 0421 33918-10
 Fax 0421 33918-22
 tb-bremen@sew-eurodrive.de

BRUCHSAL (HAUPTSITZ)

Tel. 07251 75-0
 Fax 07251 75-1970
 sew@sew-eurodrive.de

DORTMUND

Tel. 0231 229028-10
 Fax 0231 229028-20
 tb-dortmund@sew-eurodrive.de

DRESDEN

Tel. 0351 26338-0
 Fax 0351 26338-38
 tb-dresden@sew-eurodrive.de

ERFURT

Tel. 0361 21709-70
 Fax 0361 21709-79
 tb-erfurt@sew-eurodrive.de

GÜSTROW

Tel. 03843 8557-80
 Fax 03843 8557-88
 tb-guestrow@sew-eurodrive.de

HAMBURG

Tel. 040 298109-60
 Fax 040 298109-70
 tb-hamburg@sew-eurodrive.de

HANNOVER/GARBSEN

Tel. 05137 8798-110
 Fax 05137 8798-550
 tb-hannover@sew-eurodrive.de

HEILBRONN

Tel. 07143 8738-0
 Fax 07143 8738-25
 tb-heilbronn@sew-eurodrive.de

HERFORD

Tel. 05221 9141-0
 Fax 05221 9141-20
 tb-herford@sew-eurodrive.de

KARLSRUHE

Tel. 07245 9190-10
 Fax 07245 9190-20
 tb-karlsruhe@sew-eurodrive.de

KASSEL

Tel. 0561 95144-80
 Fax 0561 95144-90
 tb-kassel@sew-eurodrive.de

KOBLENZ

Tel. 02630 91930-10
 Fax 02630 91930-90
 tb-koblenz@sew-eurodrive.de

LAHR

Tel. 07821 90999-60
 Fax 07821 90999-79
 tb-lahr@sew-eurodrive.de

LANGENFELD

Tel. 02173 8507-10
 Fax 02173 8507-50
 tb-langenfeld@sew-eurodrive.de

LUDWIGSHAFEN

Tel. 07251 75-3759
 Fax 07251 75-503759
 dc-ludwigshafen@sew-eurodrive.de

MAGDEBURG

Tel. 039203 7577-1
 Fax 039203 7577-9
 tb-magdeburg@sew-eurodrive.de

MANNHEIM

Tel. 0621 71683-10
 Fax 0621 71683-22
 tb-mannheim@sew-eurodrive.de

MÜNCHEN/KIRCHHEIM

Tel. 089 90955-110
 Fax 089 90955-150
 tb-muenchen@sew-eurodrive.de

MÜNSTER

Tel. 0251 41475-11
 Fax 0251 41475-50
 tb-muenster@sew-eurodrive.de

NÜRNBERG

Tel. 0911 98884-50
 Fax 0911 98884-60
 tb-nuernberg@sew-eurodrive.de

REGENSBURG

Tel. 0941 46668-68
 Fax 0941 46668-66
 tb-regensburg@sew-eurodrive.de

RHEIN-MAIN/BAD HOMBURG

Tel. 06172 9617-0
 Fax 06172 9617-50
 tb-rheinmain@sew-eurodrive.de

SCHWALBACH (SAAR)

Tel. 06831 48946-10
 Fax 06831 48946-13
 dc-saarland@sew-eurodrive.de

STUTTGART

Tel. 0711 16072-0
 Fax 0711 16072-72
 tb-stuttgart@sew-eurodrive.de

ULM

Tel. 07348 9885-0
 Fax 07348 9885-90
 dc-ulm@sew-eurodrive.de

WÜRZBURG

Tel. 0931 27886-60
 Fax 0931 27886-66
 dc-wuerzburg@sew-eurodrive.de

ZWICKAU/MEERANE

Tel. 03764 7606-0
 Fax 03764 7606-20
 tb-zwickau@sew-eurodrive.de

ARGENTINA

Tel. +54 3327 4572-84
 Fax +54 3327 4572-21
 sewar@sew-eurodrive.com.ar

AUSTRALIA

Tel. +61 3 9933-1000
 Fax +61 3 9933-1003
 enquires@sew-eurodrive.com.au

AUSTRIA

Tel. +43 1 617 55 00-0
 Fax +43 1 617 55 00-30
 sew@sew-eurodrive.at

BELARUS

Tel. +375 17 298 47 56
 Fax +375 17 298 47 54
 sales@sew.by

BELGIUM

Tel. +32 16 386-311
 Fax +32 16 386-336
 info@sew-eurodrive.be

BRAZIL

Tel. +55 19 3835-8000
 sew@sew.com.br

CAMEROON

Tel. +237 233 39 12 35
 Fax +237 233 39 02 10
 sew@sew-eurodrive.cm

CANADA

Tel. +1 905 791-1553
 Fax +1 905 791-2999
 marketing@sew-eurodrive.ca

CHILE

Tel. +56 2 2757 7000
 Fax +56 2 2757 7001
 ventas@sew-eurodrive.cl

CHINA

Tel. +86 22 25322612
 Fax +86 22 25323273
 info@sew-eurodrive.cn

COLOMBIA

Tel. +57 1 54750-50
 Fax +57 1 54750-44
 sew@sew-eurodrive.com.co

CZECH REPUBLIC

Tel. +420 255 709 601
 Fax +420 235 350 613
 sew@sew-eurodrive.cz

DENMARK

Tel. +45 4395 8500
 Fax +45 4395 8509
 sew@sew-eurodrive.dk

FINLAND

Tel. +358 201 589-300
 Fax +358 3 780-6211
 sew@sew.fi

FRANCE

Tel. +33 3 88 73 67 00
 Fax +33 3 88 73 66 00
 sew@usocome.com

GHANA

Tel. +233 303 963 772
 info@sew-eurodrive.com.gh

GREAT BRITAIN

Tel. +44 1924 893-855
 Fax +44 1924 893-702
 info@sew-eurodrive.co.uk

HUNGARY

Tel. +36 1 437 06-58
 Fax +36 1 437 06-50
 office@sew-eurodrive.hu

INDIA

Tel. +91 265 3045200
 Fax +91 265 3045300
 marketing@seweurodriveindia.com

ITALY

Tel. +39 02 96 9801
 Fax +39 02 96 980 999
 sewit@sew-eurodrive.it

IVORY COAST

Tel. +225 21 21 81 05
 Fax +225 21 25 30 47
 info@sew-eurodrive.ci

JAPAN

Tel. +81 538 373811
 Fax +81 538 373814
 sewjapan@sew-eurodrive.co.jp

KAZAKHSTAN

Tel. +7 727 350 5156
 Fax +7 727 350 5156
 sew@sew-eurodrive.kz

MALAYSIA

Tel. +60 7 8590288
 Fax +60 7 8590629
 sales@sew-eurodrive.com.my

MEXICO

Tel. +52 442 1030-300
 Fax +52 442 1030-301
 scmexico@seweurodrive.com.mx

MOROCCO

Tel. +212 522 88 85 00
 Fax +212 522 88 84 50
 sew@sew-eurodrive.ma

NETHERLANDS

Tel. +31 10 4463-700
 Fax +31 10 4155-552
 info@sew-eurodrive.nl

NEW ZEALAND

Tel. +64 9 2745627
 Fax +64 9 2740165
 sales@sew-eurodrive.co.nz

NORWAY

Tel. +47 69 24 10 20
 Fax +47 69 24 10 40
 sew@sew-eurodrive.no

PARAGUAY

Tel. +595 991 519695
 Fax +595 21 3285539
 sewpy@sew-eurodrive.com.py

PERU

Tel. +51 1 3495280
 Fax +51 1 3493002
 sewperu@sew-eurodrive.com.pe

POLAND

Tel. +48 42 293 00 00
 Fax +48 42 293 00 49
 sew@sew-eurodrive.pl

PORTUGAL

Tel. +351 231 20 9670
 Fax +351 231 20 3685
 infosew@sew-eurodrive.pt

RUSSIA

Tel. +7 812 3332522
 Fax +7 812 3332523
 sew@sew-eurodrive.ru

SINGAPORE

Tel. +65 68621701
 Fax +65 68612827
 sewsingapore@sew-eurodrive.com

SLOVAKIA

Tel. +421 2 33595 202
 Fax +421 2 33595 200
 sew@sew-eurodrive.sk

SOUTH AFRICA

Tel. +27 11 248 7000
 Fax +27 11 248 7289
 info@sew.co.za

SOUTH KOREA

Tel. +82 31 492-8051
 Fax +82 31 492-8056
 master.korea@sew-eurodrive.com

SPAIN

Tel. +34 94 4318470
 sew.spain@sew-eurodrive.es

SWEDEN

Tel. +46 36 34 42 00
 Fax +46 36 34 42 80
 sew@sew-eurodrive.se

SWITZERLAND

Tel. +41 61 41717-17
 Fax +41 61 41717-00
 info@imhof-sew.ch

TANZANIA

Tel. +255 22 277 5780
 Fax +255 22 277 5788
 info@sew.co.tz

THAILAND

Tel. +66 38 454281
 Fax +66 38 454288
 sewthailand@sew-eurodrive.com

TURKEY

Tel. +90 262 999 1000-04
 Fax +90 262 999 1009
 sew@sew-eurodrive.com.tr

UKRAINE

Tel. +380 56 370 3211
 Fax +380 56 372 2078
 sew@sew-eurodrive.ua

UNITED ARAB EMIRATES

Tel. +971 4 8086 500
 Fax +971 4 8086 464
 info@sew-eurodrive.ae

URUGUAY

Tel. +598 2 2118189
 Fax +598 2 2118190
 sewuy@sew-eurodrive.com.uy

USA

Tel. +1 864 439-7537
 Fax +1 864 439-7830
 cslyman@seweurodrive.com

VENEZUELA

Tel. +58 241 832-9804
 Fax +58 241 838-6275
 ventas@sew-eurodrive.com.ve

VIETNAM

Tel. +84 937 299 700
 huytam.phan@sew-eurodrive.com

