



DRUM MOTORS UNIT HANDLING

GENERAL CATALOGUE

Moving ahead.



**DRUM MOTORS
UNIT HANDLING**

Moving ahead.



Rulmeca - Moving ahead.

Since its foundation in 1962, the Rulmeca Group, headquartered in Bergamo (Almé), Italy, has grown to become one of the world's leading manufacturers of premium components for material handling. We strongly believe in our positioning as a component supplier and have successfully remained faithful to our mission for more than 50 years.

Our reliability as a partner has made Rulmeca one of the most trusted brands in the industry.

As a family-owned business, a long-term perspective and responsible action form the basis of Rulmeca Group's economic success. The unique combination of tradition and innovation, of quality and service is our key success factor. This is also seen in our consistent environmental and social responsibility throughout the value chain. More than 1200 employees in twenty-two production and sales companies all around the globe serve Rulmeca clients in 85 countries.

Along with our products, which help to handle and move bulk materials and unit loads all over the globe, the Rulmeca Group is also moving ahead. Building on our experience supplying to OEM and end users in Italy, one of Europe's key markets for unit handling applications, we have developed a comprehensive range of components for internal logistics: made by Rulmeca. Our aim? To remain the preferred supplier and trusted partner for our customers who produce and engineer machinery, equipment and systems for unit handling applications.

We believe we have something important to offer to our customers.

Rulmeca's international presence allows us to access the most efficient sources of procurement, thus boosting the competitiveness of our offering.

At the same time our extensive network of affiliated companies and business partners allows us to always be in close contact with our customers. As a vertically integrated manufacturer, we have the flexibility to respond to individual needs whenever they arise.

Today the Rulmeca Group's global business encompasses three product brands: Rulmeca, Precismeca and Melco. They are part of one Group, they share a common philosophy, but each has its own character and operates according to the

specific needs of its markets and its customers. Following this strategy, Rulmeca Group has evolved in recent decades to become the world's largest producer of belt conveyor rollers/idlers and drum motor in the bulk handling industry.

We don't only sell products, we find solutions. Our research departments are equipped with dedicated test facilities, where our products are thoroughly examined under extreme conditions. We are committed to the development of new products and the continuous improvement of our current range, often considered among the best in the market. Components provided by the Rulmeca Group improve the performance, safety and reliability of the systems, equipment and machines produced and utilized by our customers.

With the benefit of these assets and this strategic focus, the Rulmeca Group offers a portfolio of state-of-the-art components for a vast array of industries and applications handling both bulk materials and unit loads.

Our new range of Rulmeca unit handling components comprises rollers, drum motor, 24V drive rollers and controls, as well as modules for dynamic storage. This range of products has been developed for demanding applications such as airport logistics, postal and parcel handling, and logistics applications in manufacturing, distribution centers, food and beverage processing and warehousing.

For us, this catalogue is an important milestone.

And we will keep on moving ahead.

Please stay tuned.

Kind regards from The Rulmeca Team

PS: Feel free to contact your local Rulmeca Company - www.rulmeca.com.

We look forward to receiving your feedback and comments.

INDEX

Drum motor benefits	7	■ Options	70
Applications for Rulmeca drum motors	8	Lagging for standard belts - smooth or specially grooved lagging to increase friction between the shell and conveyor belt	72
Standard drum motor range	9	Lagging for standard belts - V-groove section - smooth and specially grooved lagging to increase friction between the shell and conveyor belt	73
■ Light industrial drum motor range	10	Profiled lagging for plastic modular belts – specially produced lagging, profiled to suit the belt manufacturers series of plastic modular belt	74
Drum motor 80LP Ø 85.5mm 0.06kW - 0.12kW, with planetary gearbox in polymer for non-continuous operation	12	Sprockets for plastic modular belts – special laser cut sprockets based on the specification of modular belt manufacturers	75
Drum motor 113LP Ø113.5mm 0.06kW - 0.37kW, with planetary gearbox in polymer or polymer / steel combination for non-continuous operation	16	Backstop / Anti run-back bearings	76
■ Industrial drum motor range	22	Electromagnetic brakes	77
Drum motor 80LS Ø 81.5mm 0.035kW - 0.16kW, with steel helical gearbox	24	Rectifiers	79
Drum motor 113LS Ø113.0mm 0.035kW - 0.55kW, with steel helical gearbox	30	Encoder SKF	80
Drum motor 138LS Ø 138.5mm 0.10kW - 1.00kW, with steel helical gearbox	38	Encoder RLS	82
Drum motor 165LS Ø 165mm 0.11kW - 2.20kW, with steel helical gearbox	45	■ Accessories	84
Drum motor 216LS Ø 216mm 0.11kW - 2.20kW, with steel helical gearbox	52	Mounting brackets for drum motor and idler	85
Drum motor 220M-H Ø 216mm 0.37kW - 5.5kW with steel helical gearbox	58	■ Planning section	86
Drum motors 320 - 1000 - summary table	66	Environmental conditions	88
		Different power supply	91
		Industrial solutions	91
		Certifications	91
		Power calculations and selection of the drum motor for unit handling	92
		Required data for power calculation	93
		Technical Precautions for design, installation and maintenance	94
		IP ratings	99
		Oil types and contents	100
		Cables	102
		Connection diagrams	103

DRUM MOTOR BENEFITS



Reduced energy consumption

Compared to many corresponding motor and gearbox systems commonly used in industry, Rulmeca drum motors are able to use less energy for the same performance, helping to reduce power consumption, benefiting the environment and reducing energy costs.



Increased efficiency

Rulmeca drum motors have a higher efficiency compared to traditional motor transmission systems, which are normally able to transfer approximately 75% of the power used to the belt. A Rulmeca drum motor is able to transfer up to 97% mechanical efficiency.



Ease of installation

Rulmeca drum motors are much faster and easier to install when compared to traditional multiple component motor transmission systems, typically requiring less than a quarter of the time for installation. With fewer parts to consider, conveyor design and assembly is easier and quicker, procurement is also simplified reducing overall costs.



Space-saving design

With motor, bearings and gearbox enclosed inside the casing, drum motors are very compact, requiring less space, increasing the aesthetic and functional value of the finished conveyor.



Designed for the toughest conditions

The Rulmeca drum motor is designed to operate perfectly even in the most aggressive environmental conditions such as, in the presence of water, dust, grit, chemicals, grease, oil and even during high pressure wash-down procedures.



Guaranteed for food

Thanks to its flat smooth surfaces, stainless steel finish and totally enclosed, hermetically sealed design, Rulmeca drum motors are easy to clean reducing contamination risk in food processing environments.



Safety

Component parts are totally enclosed within a Rulmeca drum motor. With the external shafts held captive in a conveyor frame, the only moving part is the body of the pulley running under the conveyor belt. Conveyors can be designed in such a way preventing any of the drive pulley to be visible, resulting in an extremely safe method to drive conveyor belts.



Maintenance-free

The fully sealed design ensures that internal parts are not exposed to external environmental conditions or tampering. A completely self contained unit, requiring no maintenance throughout its service lifetime.

APPLICATIONS FOR RULMECCA DRUM MOTORS

Standard conveyor belts

To drive standard belts using the friction between the drum motor shell and the underside of the conveyor belt. The belt, which passes over the drum motor works as a heat sink, taking the heat produced by the electric motor and allowing it to dissipate away.

Plastic modular belts

For applications that involve the use of plastic modular belts, it is necessary to cover the drum motor with a profiled lagging or to fit laser cut profiled sprockets to the shell of the pulley, to provide positive drive to the belt.
Please contact Rulmecca to select optimum drive solution.

Thermoplastic positively driven belts

Thermoplastic belt applications require drum motors to be fitted with profiled lagging to suit, in order to provide positive drive.
Please contact Rulmecca to select optimum drive solution.

Non-Belt applications

For applications that do not require the use of belts, such as for moving product in direct contact with the pulley, or for brush cleaning applications. To prevent overheating we would recommend the adoption of frequency converters.
Please contact Rulmecca to select specification.

STANDARD DRUM MOTOR RANGE

		LIGHT INDUSTRIAL DRUM MOTOR RANGE		INDUSTRIAL DRUM MOTOR RANGE						
		80LP	113LP	80LS	113LS	138LS	165LS	216LS	220M	220H
Diameter [mm]		85.5	113.6	81.5	113.0	138.5	165	216	216	216
Power [kW]	from	0.06	0.06	0.035	0.035	0.1	0.11	0.37	0.37	0.37
	to	0.12	0.37	0.16	0.55	1.00	2.20	2.20	4.00	5.50
Torque [Nm]	from	7.0	5.0	4.8	8.8	29	30	28	30	115
	to	29	75	30	106	168	340	333	409	705
Tangential Force [N]	from	127	87	120	155	345	360	264	279	2093
	to	500	1000	729	1877	2425	4100	3104	4195	6558
Speed Belt [m/s]	from	0.07	0.03	0.10	0.05	0.05	0.05	0.16	0.2	0.13
	to	0.77	1.05	1.00	1.50	1.60	3.15	4.00	2.50	2.50
Roller Length RL [mm]	from	253	256	200	250	300	350	350	400	450
	to	912	1212	1000	1200	1800	2000	2000	2000	2000







DRUM MOTOR 80LP

85.5Ø 0.06kW - 0.12kW,

with planetary gearbox in polymer for non-continuous operation

Product description

Due to its strength, reliability and no need for maintenance this drum motor is used in small conveyors, packaging machines and simple transfer units.

Characteristics

- Asynchronous motor AC three-phase or single-phase
- Single supply voltage
- On request: 3-phase dual voltage (possible delta/star connection)
- Integral motor protection
- Gearbox planetary-type polymer or polymer / steel combination
- Low noise operation
- Light and distributed weight
- Maintenance free
- Lifetime lubrication
- Reversible operation

Applications

- Small conveyors for light loads, non-continuous use
- Transfer Conveyors
- Packaging machines for light loads
- Food processing equipment, metal detection, x-ray
- Cash desks in supermarkets
- Dry, damp and wash down applications

TECHNICAL DATA

Motor Data

Type of Motor	Asynchronous squirrel-cage, IEC 34 (VDE 0530)
Insulation class of motor windings	Class F, IEC 34 (VDE 0530)
Voltage	230 or 400 V \pm 5% (IEC 34/38)
Frequency	50/60 Hz
Internal shaft sealing system	Double-lipped of nitrile rubber, NBR
External shaft sealing system	Deflection seal nitrile rubber, NBR
Protection rate	IP66
Thermal protection	Bimetallic Contact
Ambient temperature, 3-phase motor	+5 to +40 °C
Ambient temperature, 1-phase motor	+10 to +40 °C
General technical data	
Max. Roller length (RL)	912 mm

Drum motor with RL length greater than 550 mm have reinforced shaft. All data and values declared in the catalogue refer to operation with a frequency of 50 Hz.



DRUM MOTOR 80LP

85.5Ø 0.06kW - 0.12kW,

with planetary gearbox in polymer for non-continuous operation

Materials

The following drum motor components are available in different versions, as shown in the below chart, with further options for the material type as indicated.

Components	Version	Material			
		Standard Aluminium	Option		
			Steel	Stainless Steel	Brass /Nickel
Shell	Crowned	Std	✓	✓	
	Cylindrical	✓	✓	✓	
	Special crowns with grooves	✓	✓	✓	
End housing	Standard	Std		✓	
Shaft cap	Standard (with straight/90° free position cable)	Std			
	With cable protection			✓	✓
Electrical connection	Straight or 90° cable connector			✓	✓
	Elbow connector	✓		✓	

Please contact Rulmeca for further versions.

Options

- Rubber lagging for standard belts
- Dynamic balancing
- 3-phase dual supply voltage (possible delta/star connection)
- Food grade Oil (EU, FDA and USDA)
- Low temperature Oil
- Non-horizontal mounting (more than $\pm 5^\circ$)
- For special versions, please contact RULMECA

Accessories

- Mounting brackets
- Idler pulleys
- Rollers for conveyors

Cable Specifications

Cable options available:

- Standard, shielded
- Standard, unshielded
- Halogen-free, shielded
- Halogen-free, unshielded

Available lengths: 1,9 m (other lengths available on request).

DRUM MOTOR 80LP

85.5Ø 0.06kW - 0.12kW,

with planetary gearbox in polymer for non-continuous operation

TECHNICAL DATA DRUM MOTOR 80LP - 3PHASE - 50HZ - STANDARD RANGE

P_N [kW]	np	I_f [A]	gs	i	V_A [m/s]	V_N [m/s]	n_A [min ⁻¹]	M_N [Nm]	F_T [N]	TE [N]	RL [mm]			
0.06	4	0.7/0.4	3	77.10	0.06	0.07	13.6	29	500	2000	min 269 max 912			
			3	64.40	0.07	0.08	15.8	27	500					
			3	54.40	0.09	0.10	20.4	25	500					
			3	46.00	0.09	0.11	20.4	23	500					
			3	43.70	0.10	0.12	22.6	22	490					
			3	36.80	0.13	0.15	29.4	17	400					
			3	35.00	0.14	0.16	31.7	16	375					
			3	29.50	0.16	0.19	36.2	14	315					
			3	23.20	0.20	0.24	45.2	11	250					
			2	14.20	0.33	0.39	74.6	7	155		min 253 max 912			
0.12	4	1.0/0.7	3	29.50	0.16	0.19	36.2	27	500	2000	min 292 max 912			
			3	23.20	0.20	0.24	45.2	21	500					
			2	14.20	0.33	0.39	74.6	13	310					
			2	12.00	0.39	0.46	88.2	11	260					
						2	11.30	0.42	0.49	95.0	10	245	1500	min 276 max 912
			2	9.50	0.50	0.59	113.1	9	203					
			2	7.50	0.65	0.77	147.0	7	156					

TECHNICAL DATA DRUM MOTOR 80LP - 1PHASE - 50HZ - STANDARD RANGE

P_N [kW]	np	I_f [A]	gs	i	V_A [m/s]	V_N [m/s]	n_A [min ⁻¹]	M_N [Nm]	F_T [N]	TE [N]	RL [mm]			
0.06	4	0.6	3	77.1	0.06	0.07	13.6	29	500	2000	min 280 max 912			
			3	64.4	0.07	0.08	15.8	27	500					
			3	54.4	0.09	0.10	20.4	25	500					
			3	46.0	0.09	0.11	20.4	23	500					
			3	43.7	0.10	0.12	22.6	22	490					
			3	36.8	0.13	0.15	29.4	17	400					
			3	35.0	0.14	0.16	31.7	16	375					
			3	29.5	0.16	0.19	36.2	14	315					
			3	23.2	0.20	0.24	45.2	11	250					
			2	14.2	0.33	0.39	74.6	7	155		min 264 max 912			
0.075	4	0.8	3	36.8	0.13	0.15	29.4	20	480	2000	min 292 max 912			
			3	35.0	0.14	0.16	31.7	19	450					
			3	29.5	0.16	0.19	36.2	16	375					
			3	23.2	0.20	0.24	45.2	13	312					
						2	14.2	0.33	0.39	74.6	8	192	1500	min 276 max 912
			2	12.0	0.39	0.46	88.2	7	163					
			2	11.3	0.42	0.49	95.0	6	153					
			2	9.5	0.50	0.59	113.1	5	127					
0.09	4	0.9	2	36.8	0.13	0.15	29.4	24	500	2000	min 292 max 912			
			2	35.0	0.14	0.16	31.7	22	490					
			2	29.5	0.16	0.19	36.2	19	450					

 P_N Nominal mechanical power

np Number of poles

 I_f Amperage (230/400V) at full load

gs Gear stages

i Gear ratio

 V_A Theoretical actual belt (tangential) speed at full load* V_N Nominal belt (tangential) speed n_A Revolutions of shell at full load* M_N Nominal Torque at full load F_T Belt pull (tangential force) on shell at full load*

TE Maximum allowable belt tension (radial load)

RL Reference length

* Valid for unlagged shells/ values can deviate at partly or no load conditions

DRUM MOTOR 80LP

85.5Ø 0.06kW - 0.12kW,

with planetary gearbox in polymer for non-continuous operation

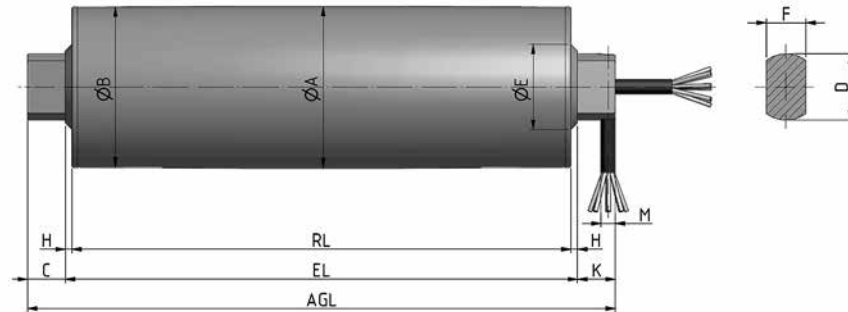

Drum motor Standard Version

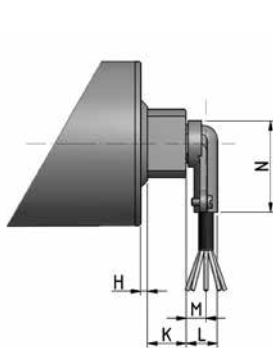

Elbow connector in aluminium

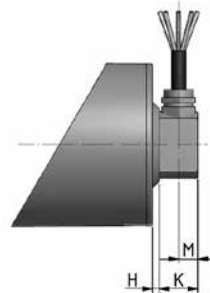

Cable connection 90°

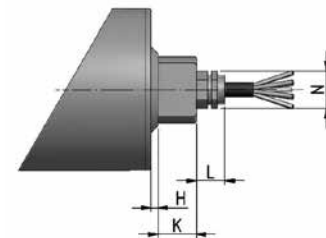

Straight connector

Type/Option	A mm	B mm	C mm	D mm	E mm	F mm	G mm	H mm	K mm	L mm	M mm	N mm	Q mm	T mm
Drum motor Standard Version	85.5	84.5	20	35	45	21		3	20		8			
Elbow connector in aluminium									20	18	12	48		
Cable connection 90°									20		10			
Straight Connector									20	15		20		

Average weights for drum motor & idler type 80LP

RL [mm]	300	350	400	450	500	550	600	650	700	750	800	850	900
all motors	4.3	4.5	4.7	4.9	5.1	5.3	5.5	5.7	5.9	6.1	6.3	6.5	6.7
idler 80LP	1.5	2.0	2.2	2.5	2.7	3.0	3.2	3.5	3.7	4.0	4.2	4.5	4.7

- Weights are orientative due to different shell executions and motor powers

DRUM MOTOR 113LP

113.5Ø 0.06kW - 0.37kW, with planetary gearbox
in polymer or polymer / steel combination for non-continuous operation

Product description

This Pulley is the ideal operator for light and medium conveyors, for non-continuous use.

Characteristics

- 3-phase or 1-phase AC induction motor
- Single supply voltage
- on request: 3-phase dual supply voltage (possible delta/star connection)
- Integral motor protection
- Gearbox planetary-type polymer or polymer / steel combination
- Low noise operation
- Light and distributed weight
- Maintenance free
- Reversible operation

Applications

- Conveyors for light loads, non continuous use
- Recycling bottles
- Packaging equipment
- X-ray inspection systems at airports
- Pharmaceutical industry
- Food processing
- Cash desks in supermarkets
- Dry, Damp and frequent wash down applications

TECHNICAL DATA

Motor Data

Type of Motor	Asynchronous squirrel-cage, IEC 34 (VDE 0530)
Insulation class of motor windings	Class F, IEC 34 (VDE 0530)
Voltage	230 or 400 V ± 5% (IEC 34/38)
Frequency	50/60 Hz
Internal shaft sealing system	Double-lipped of nitrile rubber, NBR
External shaft sealing system	Deflection seal nitrile rubber, NBR
Protection rate	IP66
Thermal protection	Bimetallic Contact
Ambient temperature, 3-phase motor	+5 to +40 °C
Ambient temperature, 1-phase motor	+10 to +40 °C
General technical data	
Max. Roller length (RL)	1212 mm

Drum motor with RL length greater than 706 mm have reinforced shaft.

All data and values declared in the catalogue refer to operation with a frequency of 50 Hz.



DRUM MOTOR 113LP

113.5Ø 0.06kW - 0.37kW, with planetary gearbox
in polymer or polymer / steel combination for non-continuous operation

Materials

The following drum motor components are available in different versions, as shown in the below chart, with further options for the material type as indicated.

Components	Version	Material			
		Standard Aluminium	Option		
			Steel	Stainless Steel	Brass /Nickel
Shell	Crowned	Std	✓	✓	
	Cylindrical	✓	✓	✓	
	Special crowns with grooves	✓	✓	✓	
End housing	Standard	Std		✓	
Shaft cap	Standard	Std			
	With cable protection			✓	✓
Electrical connection	Straight or 90° cable connector			✓	✓
	Elbow connector	✓		✓	

Please contact Rulmeca for further versions.

Options

- Rubber lagging for standard belts
- Dynamic balancing
- 3-phase dual supply voltage (possible delta/star connection)
- Oil for Food (EU, FDA and USDA)
- Oil for low temperatures
- Non-horizontal mounting (more than $\pm 5^\circ$)
- For special versions, please contact RULMECA.

Accessories

- Mounting brackets
- Idler Pulleys
- Rollers for conveyors

Cable Specifications

Cable options available:

- Standard, screened
- Standard, unscreened
- Halogen-free, screened
- Halogen-free, unscreened

Available lengths: 1,9 m (other lengths available on request).

DRUM MOTOR 113LP

113.5Ø 0.06kW - 0.37kW, with planetary gearbox

in polymer or polymer / steel combination for non-continuous operation

TECHNICAL DATA DRUM MOTOR 113LP - 3PHASE - 50HZ - STANDARD RANGE

P_N [kW]	np (rpm)	I_f [A]	gs	i	V_A [m/s]	V_N [m/s]	n_A [min ⁻¹]	M_N [Nm]	F_T [N]	TE [N]	RL [mm]		
0.06	4	0.9/0.4	4	267.7	0.03	0.03	5.1	75	1000	2000	min 256 max 1212		
				204.5	0.03	0.04	5.1	68	1000				
				120.2	0.05	0.06	8.4	56	1000				
			3	92.9	0.07	0.08	11.8	43	750				
				63.4	0.10	0.12	16.8	28	500				
				48.4	0.13	0.15	21.9	23	400				
				37.3	0.17	0.20	28.6	17	300				
				28.6	0.22	0.26	37.0	13	231				
				24.9	0.26	0.31	43.8	11	194				
				21.9	0.31	0.36	52.2	10	167				
			2	14.9	0.43	0.50	72.4	7	120			1500	
				11.3	0.59	0.69	99.3	5	87				
0.12	4	1.2/0.7	3	63.4	0.10	0.12	16.8	57	1000	2000	min 256 max 1212		
				48.4	0.13	0.15	21.9	45	800				
				37.3	0.17	0.20	28.6	34	600				
				28.6	0.22	0.26	37.0	26	462				
				24.9	0.26	0.31	43.8	22	387				
			2	21.9	0.31	0.36	52.2	19	333				
				14.9	0.43	0.50	72.4	14	240				
				11.3	0.59	0.59	99.3	10	174				
				9.9	0.69	0.81	116.2	9	148				
				37.3	0.17	0.20	28.6	51	900			2000	min 256 max 1212
3	28.6	0.22	0.26	37.0	39	692							
	24.9	0.26	0.31	43.8	33	581							
	21.9	0.31	0.36	52.2	29	500							
2	14.9	0.43	0.50	72.4	21	360							
	11.3	0.59	0.69	99.3	15	261							
	9.9	0.69	0.81	116.2	13	222							
	8.7	0.77	0.91	129.6	11	198							
	7.5	0.89	1.05	149.8	10	171							
0.18	4	1.2/0.7	3	28.6	0.22	0.26	37.0	55	962	2000	min 276 max 1212		
				24.9	0.26	0.31	43.8	46	806				
				21.9	0.31	0.36	52.2	39	694				
			2	14.9	0.43	0.50	72.4	29	500				
				11.3	0.59	0.69	99.3	21	362				
				9.9	0.69	0.81	116.2	18	309				
				8.7	0.77	0.91	129.6	16	275				
				7.5	0.89	1.05	149.8	14	238				
				28.6	0.22	0.26	37.0	55	962			2000	min 294 max 1212
				3	24.9	0.26	0.31	43.8	46				
21.9	0.31	0.36	52.2		39	694							
2	14.9	0.43	0.50	72.4	29	500							
	11.3	0.59	0.69	99.3	21	362							
	9.9	0.69	0.81	116.2	18	309							
	8.7	0.77	0.91	129.6	16	275							
	7.5	0.89	1.05	149.8	14	238							
0.25	4	1.8/1.2	3	28.6	0.22	0.26	37.0	55	962	2000	min 294 max 1212		
				24.9	0.26	0.31	43.8	46	806				
				21.9	0.31	0.36	52.2	39	694				
			2	14.9	0.43	0.50	72.4	29	500				
				11.3	0.59	0.69	99.3	21	362				
				9.9	0.69	0.81	116.2	18	309				
				8.7	0.77	0.91	129.6	16	275				
				7.5	0.89	1.05	149.8	14	238				
0.37	4	2.3/1.2	3	21.9	0.31	0.36	52.2	58	1028	2000	min 294 max 1212		
				14.9	0.43	0.50	72.4	42	740				
			2	11.3	0.59	0.69	99.3	31	536				
				9.9	0.69	0.81	116.2	26	457				
				8.7	0.77	0.91	129.6	23	407				
				7.5	0.89	1.05	149.8	20	352				

P_N Nominal mechanical power
 np Number of poles
 I_f Amperage (230/400V) at full load
 gs Gear stages
 i Gear ratio
 V_A Theoretical actual belt (tangential) speed at full load*

V_N Nominal belt (tangential) speed
 n_A Revolutions of shell at full load*
 M_N Nominal Torque at full load
 F_T Belt pull (tangential force) on shell at full load*
 TE Maximum allowable belt tension (radial load)

RL Reference length
 * Valid for unlagged shells/ values can deviate at partly or no load conditions

DRUM MOTOR 113LP

113.5Ø 0.06kW - 0.37kW, with planetary gearbox

in polymer or polymer / steel combination for non-continuous operation

TECHNICAL DATA DRUM MOTOR 113LP - 1PHASE - 50HZ - STANDARD RANGE

P_N [kW]	np (rpm)	I_T [A]	gs	i	V_A [m/s]	V_N [m/s]	n_A [min ⁻¹]	M_N [Nm]	F_T [N]	TE [N]	RL [mm]						
0.06	4	0.7	4	267.7	0.03	0.03	6.8	75	1000	2000	min 256 max 1212						
				204.5	0.03	0.04	6.8	68	1000								
				120.2	0.05	0.06	11.3	56	1000								
				92.9	0.07	0.08	15.8	43	750								
			3	63.4	0.10	0.12	22.6	28	500								
				48.4	0.13	0.15	29.4	23	400								
				37.3	0.17	0.20	38.4	17	300								
				28.6	0.22	0.26	49.7	13	231								
				24.9	0.26	0.31	58.8	11	194								
				21.9	0.31	0.36	70.1	10	167								
				2	14.9	0.43	0.50	97.2	7			120					
			11.3		0.59	0.69	133.4	5	87								
			0.12	4	2.5/0.9	3	63.4	0.10	0.12			16.8	57	1000	2000	min 256 max 1212	
							48.4	0.13	0.15			21.9	45	800			
37.3	0.17	0.20					28.6	34	600								
28.6	0.22	0.26					37.0	26	462								
24.9	0.26	0.31					43.8	22	387								
21.9	0.31	0.36					52.2	19	333								
2	14.9	0.43				0.50	72.4	14	240								
	11.3	0.59				0.59	99.3	10	174								
	9.9	0.69				0.81	116.2	9	148								
	0.15	4				2.7/1.5	3	63.4	0.10	0.12	16.8	71	1000	2000			min 256 max 1212
48.4			0.13	0.15	21.9			56	1000								
37.3			0.17	0.20	28.6			43	750								
28.6			0.22	0.26	37.0			33	578								
24.9			0.26	0.31	43.8			28	484								
21.9			0.31	0.36	52.2			24	416								
2			14.9	0.43	0.50		72.4	18	300								
			11.3	0.59	0.59		99.3	13	218								
			9.9	0.69	0.81		116.2	11	185								
			0.18	4	2.9/2.3		3	37.3	0.17	0.20	28.6	51	900		2000	min 276 max 1212	
28.6	0.22	0.26				37.0		39	692								
24.9	0.26	0.31				43.8		33	581								
21.9	0.31	0.36				52.2		29	500								
2	14.9	0.43				0.50	72.4	21	360								
	11.3	0.59				0.69	99.3	15	261								
	9.9	0.69				0.81	116.2	13	222								
	8.7	0.77				0.91	129.6	11	198								
	7.5	0.89				1.05	149.8	10	171								
	0.37	4				4.6/1.9	3	28.6	0.22	0.26	37.0	55	962	2000			min 294 max 1212
24.9			0.26	0.31	43.8			46	806								
21.9			0.31	0.36	52.2			39	694								
2			14.9	0.43	0.50		72.4	29	500								
			11.3	0.59	0.69		99.3	21	362								
			9.9	0.69	0.81		116.2	18	309								
			8.7	0.77	0.91		129.6	16	275								
			7.5	0.89	1.05		149.8	14	238								
			1500	1500	1500		1500	1500	1500	1500	1500	1500	1500		1500	1500	

DRUM MOTOR 113LP

113.5Ø 0.06kW - 0.37kW, with planetary gearbox
in polymer or polymer / steel combination for non-continuous operation

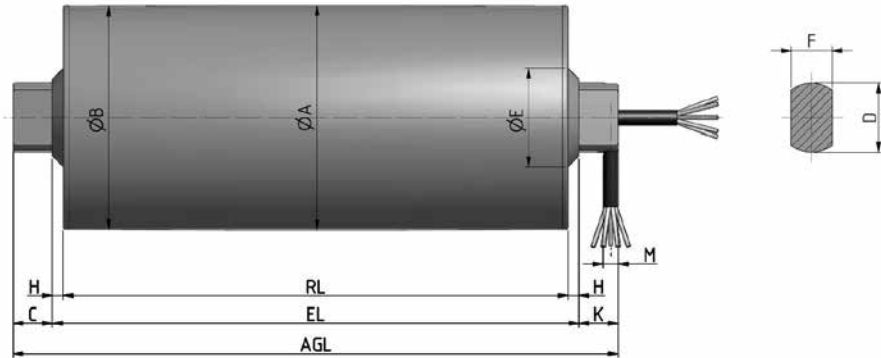

Drum motor Standard Version

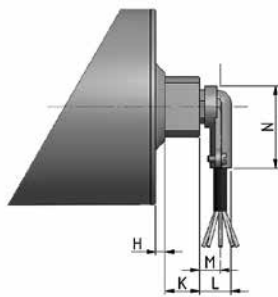

Elbow connector in aluminium

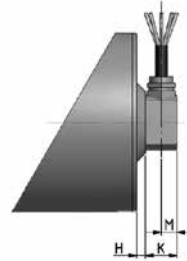

Cable connection 90°

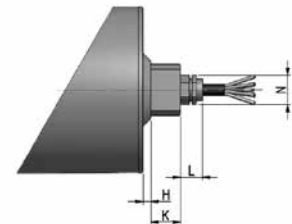

Straight connector

DRUM MOTOR 113LP

113.5Ø 0.06kW - 0.37kW, with planetary gearbox

in polymer or polymer / steel combination for non-continuous operation

Type/Option	A mm	B mm	C mm	D mm	E mm	F mm	G mm	H mm	K mm	L mm	M mm	N mm	Q mm	T mm
Drum Motor Standard EL=11 Version	113,6	112,6	20	35	50	21		5,5	20		8			
Drum Motor Alternative EL=6 Version	113,6	112,6	20	35	50	21		3	20		8			
Elbow connector in aluminium									20	18	12	48		
Cable connection 90°									20		10			
Straight Connector									20	15		20		

Average weights for drum motor & idler type 113LP

RL [mm]	300	350	400	450	500	550	600	650	700	750	800	+50mm up to	1200
all motors	6.8	7.2	7.5	7.9	8.2	8.6	8.9	9.3	9.6	11.0	11.4	+0.45 kg up to	14.9
idler 80LP	2.0	2.4	2.8	3.2	3.6	4.0	4.4	4.8	5.2	5.6	6.0	+0.35 kg up to	8.8

- Weights are orientative due to different shell executions and motor powers

INDUSTRIAL DRUM MOTOR RANGE





DRUM MOTOR 80LS

81.5Ø 0.035kW - 0.16kW, with steel helical gearbox

Product description

This drum motor is perfect for high torque applications with limited space or access.

Characteristics

- Salt water resistant aluminum bearing housings
- Three phase AC induction motor
- 3-phase dual voltage is standard
- Integral motor protection
- Hardened steel helical gear box
- Low noise operation
- Maintenance free
- Lifetime lubrication
- Reversible operation
- Reinforced internal shaft for RL exceeding 500 mm

Applications

- Small conveyors for feeding materials with frequent cycle
- Packaging equipment
- Dynamic weighing equipment
- Metal detectors
- Ideal for pharmaceutical industry
- Meat processing
- Steel or plastic modular belts applications
- Dry, humid and wash down applications

TECHNICAL DATA

Motor Data

Type of Motor	Asynchronous squirrel-cage, IEC 34 (VDE 0530)
Insulation class of motor windings	Class F, IEC 34 (VDE 0530)
Derated windings (20% power reduction)	On request for applications without belt
Voltage	230/400 V ± 5% (IEC 34/38) Special voltage on request
Frequency	50/60 Hz
Internal shaft sealing system	Double-lipped FPM or nitrile; NBR
Protection rate	IP66, IP69 in TS8N Version
Thermal protection	Bimetallic Contact
Ambient temperature, 3-phase motor	-5°C to +40°C mineral oil -25°C to +40°C synthetic oil

General technical data

Max. Roller length (RL)	1000 mm
-------------------------	---------

All data and values declared in the catalogue refer to operation with a frequency of 50 Hz.



DRUM MOTOR 80LS

81.5Ø 0.035kW - 0.16kW, with steel helical gearbox

Materials

The following drum motor components are available in different versions, as shown in the below chart, with further options for the material type as indicated.

Components	Version	Material				
		Aluminium	Steel	Stainless Steel	Brass /Nickel	Polymer
Shell	Crowned		Std	TS8N		
	Cylindrical		Std	TS8N		
	Cylindrical + key (for sprockets)		Std	TS8N		
	Special crowns and grooves		Std	TS8N		
End housing	Standard	Std		TS8N		
	With V-grooves			TS8N		
	With O-grooves			TS8N		
Shaft	Standard			Std		
	Cross-drilled and threaded, M6			Std		
Electrical connection	Straight connector			TS8N	Std	
	Elbow connector			TS8N		Std
	Terminal box*	Std		TS8N		

* Shaft cap version.

Please contact Rulmeca for further versions.

TS8N Version - End Caps in stainless steel with PTFE lip seals.

Options

- Rubber Lagging for standard belts
- Profiled lagging for plastic modular belts
- Profiled lagging for thermoplastic belts
- Sprockets for plastic modular belts
- Backstop / Anti run-back bearing
- Electromagnetic brake
- Rectifiers
- Encoder
- Food-grade Oil (EU, FDA and USDA)
- Non-horizontal mounting (more than $\pm 5^\circ$)
- Dynamic balancing

Note

The combination of encoder and electromagnetic brake is not possible.

Accessories

- Mounting brackets
- Idler Pulleys
- Rollers for conveyors
- Shaft cap
- Frequency Converters

DRUM MOTOR 80LS

81.5Ø 0.035kW - 0.16kW, with steel helical gearbox

TECHNICAL DATA DRUM MOTOR 80LS - 3PHASE - 50HZ - STANDARD RANGE

P_N [kW]	np (rpm)	I_f [A]	gs	i	V_A [m/s]	V_N [m/s]	n_A [min ⁻¹]	M_N [Nm]	F_T [N]	TE [N]	RL [mm]
0.035	4 (1390)	0.49/0.28	3	53.89	0.11	0.11	25.8	12.3	303.9	3600	min 200 max 1000
				37.78	0.16	0.14	36.8	8.6	213.1		
				30.88	0.19	0.18	45.0	7.1	174.2		
			2	21.23	0.28	0.25	65.5	4.8	119.7	2650	
0.07	4 (1360)	0.75/0.43	3	53.89	0.11	0.10	25.2	25.2	621.3	3600	min 250 max 1000
				37.78	0.15	0.14	36.0	17.6	435.6		
				30.88	0.19	0.18	44.0	14.4	356.0		
			2	21.23	0.27	0.25	64.1	9.9	244.8	2650	
				14.88	0.39	0.38	91.4	6.9	171.6		
				12.16	0.47	0.45	111.8	5.7	140.2		
	2 (2650)	0.54/0.31	3	53.89	0.21	0.22	49.2	12.9	318.9	2650	min 200 max 1000
				37.78	0.30	0.32	70.1	9.1	223.5		
2			30.88	0.36	0.38	85.8	7.4	182.7	2100		
			21.23	0.53	0.55	124.8	5.1	125.6			
0.12	2 (2690)	0.67/0.39	3	53.89	0.21	0.22	49.9	21.8	538.5	2650	min 250 max 1000
				37.78	0.30	0.32	71.2	15.3	377.5		
				30.88	0.37	0.38	87.1	12.5	308.6		
			2	21.23	0.54	0.55	126.7	8.6	212.1	2100	
				14.88	0.77	0.80	180.8	6.0	148.7		
				12.16	0.94	1.00	221.2	4.9	121.5		
0.16	2 (2650)	0.88/0.51	3	53.89	0.21	0.22	49.3	29.5	728.8	2650	min 300 max 1000
				37.78	0.30	0.32	70.0	20.7	510.9		
				30.88	0.36	0.38	85.8	16.9	417.6		
			2	21.23	0.53	0.55	124.7	11.6	287.1	2100	
				14.88	0.76	0.80	178.0	8.2	201.2		
				12.16	0.92	1.00	217.9	6.7	164.5		

P_N Nominal mechanical power

np Number of poles

rpm Actual rotor rpm at full load

I_f Amperage (230/400V) at full load

gs Gear stages

i Gear ratio

V_A Theoretical actual belt (tangential) speed at full load*

V_N Nominal belt (tangential) speed

n_A Revolutions of shell at full load*

M_N Nominal Torque at full load

F_T Belt pull (tangential force) on shell at full load*

TE T1 + T2 maximum allowable belt tension (radial load)

RL Reference length

* Valid for unlagged shells/ values can deviate at partly or no load conditions

DRUM MOTOR 80LS

81.5Ø 0.035kW - 0.16kW, with steel helical gearbox

TECHNICAL DATA DRUM MOTOR 80LS - 3PHASE - 50HZ - DERATED RANGE

P_N [kW]	np (rpm)	I_f [A]	gs	i	V_A [m/s]	V_N [m/s]	n_A [min ⁻¹]	M_N [Nm]	F_T [N]	TE [N]	RL [mm]
0.06	4 (1380)	0.59/0.34	3	53.89	0.11	0.10	25.6	21.3	525	3600	min 250 max 1000
				37.78	0.15	0.14	36.5	14.9	368		
				30.88	0.19	0.18	44.7	12.2	301		
			2	21.23	0.28	0.25	65.0	8.4	207	2650	
				14.88	0.39	0.38	92.7	5.9	145		
				12.16	0.48	0.45	113.5	4.8	118		
	2 (2730)	0.35/0.20	3	53.89	0.21	0.22	50.7	10.7	265	2650	min 200 max 1000
				37.78	0.31	0.32	72.3	7.5	186		
				30.88	0.37	0.38	88.4	6.2	152		
			2	21.23	0.55	0.55	128.6	4.2	105	2100	
53.89				0.21	0.22	50.7	17.9	442	2650		
37.78				0.31	0.32	72.3	12.6	310			
0.1	2 (2730)	0.59/0.34	3	30.88	0.37	0.38	88.4	10.3		253	2650
				21.23	0.55	0.55	128.6	7.1	174		
				14.88	0.78	0.80	183.5	4.9	122		
			2	12.16	0.95	1.00	224.5	4.0	100	2100	

Derated motors are used in applications, where standard windings tend to overheat, typically in applications with no belt as modular belting, in hot environments or when thick lagging is required on shell. To gain the full benefit of the deration, the drum motor has to be operated close to or at full load. Derated motors should not be used together with Frequency Converters. In case of doubts Rulmeca offers technical support to order the optimal motor setup for the application.

P_N	Nominal mechanical power
np	Number of poles
rpm	Actual rotor rpm at full load
I_f	Amperage (230/400V) at full load
gs	Gear stages
i	Gear ratio
V_A	Theoretical actual belt (tangential) speed at full load*
V_N	Nominal belt (tangential) speed
n_A	Revolutions of shell at full load*

M_N	Nominal Torque at full load
F_T	Belt pull (tangential force) on shell at full load*
TE	T1 + T2 maximum allowable belt tension (radial load)
RL	Reference length
*	Valid for unlagged shells/ values can deviate at partly or no load conditions

Standard weights for drum motor & idler type 80LS

PN [kW]	np	Standard weight [kg] for standard RL [mm]													
		200	250	300	350	400	450	500	550	600	650	700	800	900	1000
0.035	4	2.80	3.25	3.70	4.15	4.60	5.05	5.50	5.95	6.40	6.85	7.30	8.20	9.10	10.00
0.07	4	---	3.40	3.85	4.30	4.75	5.20	5.65	6.10	6.55	7.00	7.45	8.35	9.25	10.15
	2	2.80	3.25	3.70	4.15	4.60	5.05	5.50	5.95	6.40	6.85	7.30	8.20	9.10	10.00
0.12	2	---	3.40	3.85	4.30	4.75	5.20	5.65	6.10	6.55	7.00	7.45	8.35	9.25	10.15
0.16	2	---	---	3.85	4.30	4.75	5.20	5.65	6.10	6.55	7.00	7.45	8.35	9.25	10.15
idler (UT80LS)	-	2.30	2.85	3.40	3.95	4.50	5.05	5.60	6.15	6.70	7.25	7.80	8.90	10.00	11.10

Cable specification

Available cable options:

- Standard, Screened
- Standard, Unscreened
- Halogen-free, Unscreened

Available lengths: 1/3/5 m.

Min. length with option

The following options increase the minimum length of the drum motor

Option	RL min with option mm
Electromagnetic brake	RL min. + 50 mm
Encoder	RL min. + 50 mm

DRUM MOTOR 80LS

81.5Ø 0.035kW - 0.16kW, with steel helical gearbox

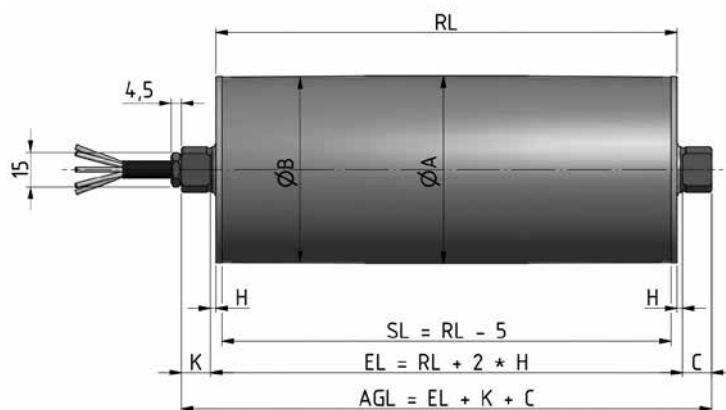

Drum motor with straight connector in stainless steel

Drum shell shape	ØA [mm]	ØB [mm]
Crowned	81.5	80.5
Cylindrical	81.0	81.0
Cylindrical with key	81.7	81.7

Shaft dimension	Width across flats [mm]	H [mm]	K [mm]	C [mm]
Ø17mm	13.5	2.5	12.5	12.5
Ø20mm standard	14.0	2.5	12.5	12.5
Ø35mm	21.0	3	20.0	20.0

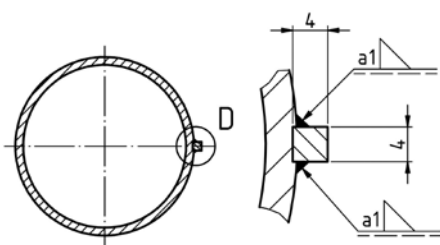

Drum motor with key 4x4

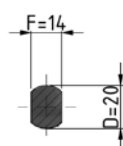

Standard shaft

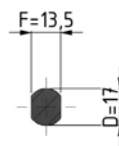

Alternative shaft

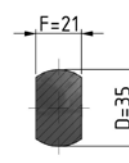

Shaft cap

DRUM MOTOR 80LS

81.5Ø 0.035kW - 0.16kW, with steel helical gearbox

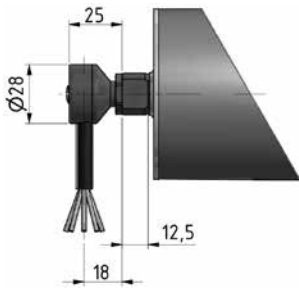

Elbow connector in stainless steel

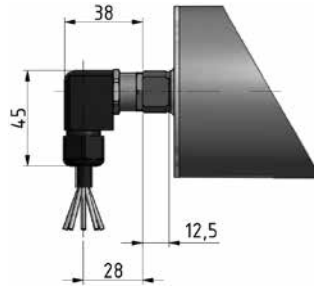

Elbow connector in polyamide

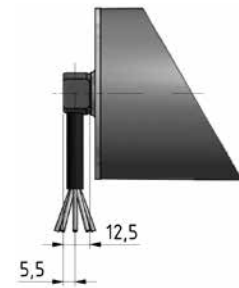

Cable slot 90° with threaded shaft

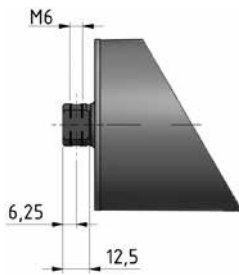

Cross-drilled and threaded shaft

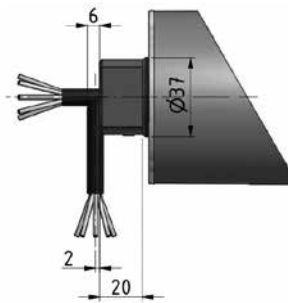

Shaft cap Uni in stainless steel

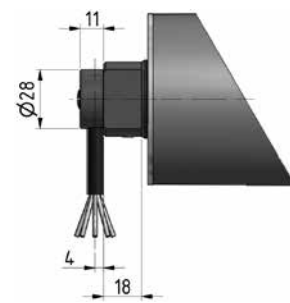

Elbow Connector with shaft cap in stainless steel

DRUM MOTOR 113LS

113.0Ø 0.035kW - 0.55kW, with steel helical gearbox

Product description

This drum motor has been designed specifically for applications that require a strong drive.

Characteristics

- Salt water resistant aluminum bearing housing
- Three phase AC induction motor
- 3-phase dual voltage standard
- Integral motor protection
- Hardened steel helical gear type
- Low noise operation
- Maintenance free
- Lifetime lubrication
- Reversible operation
- Reinforced internal shaft for RL exceeding 800 mm

Applications

- Heavy and frequent use Conveyors
- Conveyors for check-in at airports
- Packaging equipment
- Weighing Machines
- Metal detector
- Pharmaceutical industries
- Food processing
- Plastic or modular belt applications
- Dry, damp and wash down applications

TECHNICAL DATA

Motor Data

Type of Motor	Asynchronous squirrel-cage, IEC 34 (VDE 0530)
Insulation class of motor windings	Class F, IEC 34 (VDE 0530)
Derated windings (20% power reduction)	On request for applications without belt
Voltage	230/400 V ± 5% (IEC 34/38) single voltage Dual voltage or special voltage on request
Frequency	50/60 Hz
Internal shaft sealing system	Double-lipped FPM or nitrile; NBR
Protection rate	IP66, IP69 in TS8N Version
Thermal protection	Bimetallic Contact
Ambient temperature, 3-phase motor	-5°C to + 40°C mineral oil -25°C to + 40°C synthetic oil

General technical data

Max. Roller length (RL)	1200 mm
-------------------------	---------

All data and values declared in the catalogue refer to operation with a frequency of 50 Hz.



DRUM MOTOR 113LS

113.0Ø 0.035kW - 0.55kW, with steel helical gearbox

Materials

The following drum motor components are available in different versions, as shown in the below chart, with further options for the material type as indicated.

Components	Version	Material				
		Aluminium	Steel	Stainless Steel	Brass /Nickel	Polymer
Shell	Crowned		Std	TS8N		
	Cylindrical		Std	TS8N		
	Cylindrical + key (for sprockets)		Std	TS8N		
	Special crowns and grooves		Std	TS8N		
End housing	Standard	Std		TS8N		
	With V-grooves			TS8N		
	With O-grooves			TS8N		
Shaft	Standard			Std		
	Cross-drilled and threaded, M6			Std		
Electrical connection	Straight connector			TS8N	Std	
	Elbow connector			TS8N		Std
	Terminal box	Std		TS8N		

Please contact Rulmeca for further versions.

TS8N Version - End Caps in stainless steel with PTFE lip seals.

Options

- Rubber Lagging for standard belts
- Profiled lagging for plastic modular belts
- Profiled lagging for thermoplastic belts
- Sprockets for plastic modular belts
- Backstop / Anti run-back bearing
- Electromagnetic brake
- Rectifiers
- Encoder
- Food-grade Oil (EU, FDA and USDA)
- Non-horizontal mounting (more than $\pm 5^\circ$)
- Dynamic balancing

Note

The combination of encoder and electromagnetic brake is not possible.

Accessories

- Mounting brackets
- Idler Pulleys
- Rollers for conveyors
- Shaft caps
- Frequency Converters

DRUM MOTOR 113LS

113.0Ø 0.035kW - 0.55kW, with steel helical gearbox

TECHNICAL DATA DRUM MOTOR 113LS - 3PHASE - 50HZ - STANDARD RANGE

P_N [kW]	np (rpm)	I_n [A]	gs	i	V_A [m/s]	V_N [m/s]	n_A [min ⁻¹]	M_N [Nm]	F_T [N]	TE [N]	RL [mm]			
0.035	12 (420)	0.80/0.46	3	42.66	0.06	0.05	9.8	32.3	571	6550	min 250 max 1200			
				36.35	0.07	0.06	11.6	27.5	486					
				31.36	0.08	0.07	13.4	23.7	420					
0.07	12 (380)	1.11/0.64	3	42.66	0.05	0.05	8.9	71.3	1262	6550	min 300 max 1200			
				36.35	0.06	0.06	10.5	60.7	1075					
				31.36	0.07	0.07	12.1	52.4	928					
0.08	8 (635)	0.97/0.56	3	42.66	0.09	0.09	14.9	48.8	863	6550	min 250 max 1200			
0.10	6 (900)	0.90/0.52	3	42.66	0.12	0.11	21.1	43.0	761	6550				
				36.35	0.15	0.13	24.8	36.6	648					
				31.36	0.17	0.16	28.7	31.6	559					
				27.32	0.19	0.18	32.9	27.5	487					
				23.99	0.22	0.22	37.5	24.2	428					
				21.18	0.25	0.25	42.5	21.3	378					
2	15.17	0.35	2	12.92	0.41	0.40	69.7	13.0	230	4550				
				11.15	0.48	0.45	80.7	11.2	199					
				42.66	0.09	0.09	14.8	92.1	1631			6550	min 300 max 1200	
0.15	8 (630)	1.47/0.85	3	36.35	0.10	0.11	17.3	78.5	1390					
				31.36	0.12	0.13	20.1	67.7	1199					
				4 (1370)	1.02/0.59	3	42.66	0.19	0.18	32.1		42.4	750	6550
							36.35	0.22	0.22	37.7		36.1	639	
							31.36	0.26	0.25	43.7		31.1	551	
							27.32	0.30	0.30	50.1	27.1	480		
	23.99	0.34	0.32				57.1	23.8	422					
	21.18	0.38	0.38				64.7	21.0	372					
	2	15.17	0.53	2	12.92	0.63	0.63	106.0	12.8	227	4550			
					11.15	0.73	0.70	122.9	11.1	196				
					3400									
	0.20	6 (895)	1.44/0.84	3	42.66	0.12	0.13	21.0	86.5	1531	6550	min 300 max 1200		
36.35					0.15	0.14	24.6	73.7	1304					
31.36					0.17	0.16	28.5	63.6	1125					
27.32					0.19	0.20	32.8	55.4	980					
23.99					0.22	0.22	37.3	48.6	861					
21.18					0.25	0.25	42.3	42.9	760					
2				15.17	0.35	2	12.92	0.41	0.40	69.3	30.8		544	4550
							12.92	0.41	0.40	69.3	26.2		464	
							11.15	0.47	0.50	80.3	22.6		400	

P_N Nominal mechanical power

np Number of poles

rpm Actual rotor rpm at full load

I_n Amperage (230/400V) at full load

gs Gear stages

i Gear ratio

V_A Theoretical actual belt (tangential) speed at full load*

V_N Nominal belt (tangential) speed

n_A Revolutions of shell at full load*

M_N Nominal Torque at full load

F_T Belt pull (tangential force) on shell at full load*

TE T1 + T2 maximum allowable belt tension (radial load)

RL Reference length

* Valid for unlagged shells/ values can deviate at partly or no load conditions

DRUM MOTOR 113LS

113.0Ø 0.035kW - 0.55kW, with steel helical gearbox

TECHNICAL DATA DRUM MOTOR 113LS - 3PHASE - 50HZ - STANDARD RANGE

P_N [kW]	np (rpm)	I_n [A]	gs	i	V_A [m/s]	V_N [m/s]	n_A [min ⁻¹]	M_N [Nm]	F_T [N]	TE [N]	RL [mm]	
0.24	2 (2766)	1.12/0.65	3	42.66	0.38	0.38	64.8	33.6	594	4550	min 250 max 1200	
				36.35	0.45	0.45	76.1	28.6	506			
				31.36	0.52	0.50	88.2	24.7	437			
				27.32	0.60	0.60	101.2	21.5	381			
				23.99	0.68	0.70	115.3	18.9	334			
			21.18	0.77	0.80	130.6	16.7	295				
			2	15.17	1.08	1.10	182.3	11.9	211	3400		
				12.92	1.27	1.25	214.1	10.2	180			
11.15	1.47	1.50		248.1	8.8	155						
0.30	4 (1390)	1.66/0.96	3	42.66	0.19	0.20	32.6	83.5	1478	6550	min 300 max 1200	
				36.35	0.23	0.22	38.2	71.2	1260			
				31.36	0.26	0.25	44.3	61.4	1087			
				27.32	0.30	0.30	50.9	53.5	947			
				23.99	0.34	0.35	57.9	47.0	831			
			21.18	0.39	0.38	65.6	41.5	734				
			2	15.17	0.54	0.50	91.6	29.7	526	4550		
				12.92	0.64	0.63	107.6	25.3	448			
				11.15	0.74	0.70	124.7	21.8	386			
			0.37	4 (1350)	1.94/1.12	3	42.66	0.19	0.18	31.6		106.1
36.35	0.22	0.22					37.1	90.4	1600			
31.36	0.25	0.25					43.0	78.0	1380			
27.32	0.29	0.30					49.4	67.9	1202			
23.99	0.33	0.35					56.3	59.6	1056			
21.18	0.38	0.38				63.7	52.7	932				
2	15.17	0.53				0.50	89.0	37.7	668	4550		
	12.92	0.62				0.63	104.5	32.1	569			
	11.15	0.72		0.70	121.1	27.7	491					
2 (2800)	1.56/0.90			3	21.18	0.78	0.80	132.2	25.4	449	3400	
				2	15.17	1.09	1.10	184.6	18.2	322		
					12.92	1.28	1.25	216.7	15.5	274		
					11.15	1.49	1.50	251.1	13.4	237		
			0.55	2 (2790)	2.20/1.27	3	42.66	0.39	0.38	65.4		76.3
36.35	0.45	0.45					76.8	65.0	1151			
31.36	0.53	0.50					89.0	56.1	993			
27.32	0.60	0.60					102.1	48.9	865			
23.99	0.69	0.70					116.3	42.9	759			
21.18	0.78	0.80				131.7	37.9	670				
2	15.17	1.09				1.10	183.9	27.1	480	3400		
	12.92	1.28				1.25	215.9	23.1	409			
	11.15	1.48				1.50	250.2	19.9	353			

DRUM MOTOR 113LS

113.0Ø 0.035kW - 0.55kW, with steel helical gearbox

TECHNICAL DATA DRUM MOTOR 113LS - 3PHASE - 50HZ - DERATED RANGE

P_N [kW]	np (rpm)	I_n [A]	gs	i	V_A [m/s]	V_N [m/s]	n_A [min ⁻¹]	M_N [Nm]	F_T [N]	TE [N]	RL [mm]
0.12	4 (1364)	0.73/0.42	3	42.66	0.19	0.18	32.0	34.0	603	6550	min 250 max 1200
				36.35	0.22	0.22	37.5	29.0	513		
				31.36	0.26	0.25	43.5	25.0	443		
				27.32	0.30	0.30	49.9	21.8	386		
				23.99	0.34	0.32	56.9	19.1	339		
			21.18	0.38	0.38	64.4	16.9	299	4550		
			2	15.17	0.53	0.50	89.9	12.1		214	
				12.92	0.62	0.63	105.6	10.3		183	
				11.15	0.72	0.70	122.3	8.9		158	
			0.25	4 (1410)	1.44/0.83	3	42.66	0.20		0.20	
36.35	0.23	0.22					38.8	58.5	1035		
31.36	0.27	0.25					45.0	50.4	893		
27.32	0.31	0.30					51.6	43.9	778		
23.99	0.35	0.35					58.8	38.6	683		
21.18	0.39	0.38				66.6	34.1	603	4550		
2	15.17	0.55				0.50	92.9	24.4		432	
	12.92	0.65				0.63	109.1	20.8		368	
	11.15	0.75				0.70	126.5	17.9		317	3400
0.31	4 (1380)	1.64/0.95				3	42.66	0.19		0.18	32.3
			36.35	0.22	0.22		38.0	74.1	1311		
			31.36	0.26	0.25		44.0	63.9	1131		
			27.32	0.30	0.30		50.5	55.7	985		
			23.99	0.34	0.35		57.5	48.9	865		
			21.18	0.39	0.38	65.2	43.2	764	4550		
			2	15.17	0.54	0.50	91.0	30.9		547	
	12.92	0.63		0.63	106.8	26.3	466				
	11.15	0.73		0.70	123.8	22.7	402	3400			
	3	21.18	0.78	0.80	132.2	21.3	377				
		2	15.17	1.09	1.10	184.6	15.2		270		
	12.92		1.28	1.25	216.7	13.0	230				
	11.15		1.49	1.50	251.1	11.2	198				

Derated motors are used in applications, where standard windings tend to overheat, typically in applications with no belt as modular belting, in hot environments or when thick lagging is required on shell. To gain the full benefit of the deration, the drum motor has to be operated close to or at full load. Derated motors should not be used together with Frequency Converters. In case of doubts Rulmeca offers technical support to order the optimal motor setup for the application.

P_N Nominal mechanical power
 np Number of poles
 rpm Actual rotor rpm at full load
 I_n Amperage (230/400V) at full load
 gs Gear stages
 i Gear ratio
 V_A Theoretical actual belt (tangential) speed at full load*
 V_N Nominal belt (tangential) speed
 n_A Revolutions of shell at full load*

M_N Nominal Torque at full load
 F_T Belt pull (tangential force) on shell at full load*
 TE T1 + T2 maximum allowable belt tension (radial load)
 RL Reference length
 * Valid for unlagged shells/ values can deviate at partly or no load conditions

DRUM MOTOR 113LS

113.0Ø 0.035kW - 0.55kW, with steel helical gearbox

STANDARD WEIGHTS FOR DRUM MOTOR 113LS

P _N [kW]	np	Standard weight [kg] for standard RL [mm]														
		250	260	300	310	360	410	460	510	560	610	660	710	810	910	1010
0.04	12	7.20	7.35	7.95	8.10	8.85	9.60	10.35	11.10	11.85	12.60	13.35	14.10	18.80	20.30	21.80
0.07	12	---	---	10.10	10.25	11.00	11.75	12.50	13.25	14.00	14.75	15.50	16.25	20.95	22.45	23.95
0.08	8	7.20	7.35	7.95	8.10	8.85	9.60	10.35	11.10	11.85	12.60	13.35	14.10	18.80	20.30	21.80
0.10	6	7.20	7.35	7.95	8.10	8.85	9.60	10.35	11.10	11.85	12.60	13.35	14.10	18.80	20.30	21.80
0.15	8	---	---	10.10	10.25	11.00	11.75	12.50	13.25	14.00	14.75	15.50	16.25	20.95	22.45	23.95
	4	7.20	7.35	7.95	8.10	8.85	9.60	10.35	11.10	11.85	12.60	13.35	14.10	18.80	20.30	21.80
0.20	6	---	---	7.95	8.10	8.85	9.60	10.35	11.10	11.85	12.60	13.35	14.10	18.80	20.30	21.80
0.24	2	7.20	7.35	7.95	8.10	8.85	9.60	10.35	11.10	11.85	12.60	13.35	14.10	18.80	20.30	21.80
0.30	4	---	---	10.10	10.25	11.00	11.75	12.50	13.25	14.00	14.75	15.50	16.25	20.95	22.45	23.95
0.37	4	---	---	10.10	10.25	11.00	11.75	12.50	13.25	14.00	14.75	15.50	16.25	20.95	22.45	23.95
	2	---	---	10.10	10.25	11.00	11.75	12.50	13.25	14.00	14.75	15.50	16.25	20.95	22.45	23.95
idler (UT113LS)	-	5.35	6.10	6.85	7.60	8.35	9.10	9.85	10.60	11.35	12.10	12.85	13.60	14.35	15.10	16.60

Other RL dimension within the min & max RL available on request.

Cable specification

Available cable options:

- Standard, screened
- Standard, unscreened
- Halogen-free, screened
- Halogen-free, unscreened

Available lengths: 1/3/5 m.

Min. length with option

The following options increase the minimum length of the drum motor

Option	RL min with option mm
Brake	RL min + 50 mm
Encoder SKF	RL min + 0 mm
Encoder RLS	RL min +50 mm

DRUM MOTOR 113LS

113.0Ø 0.035kW - 0.55kW, with steel helical gearbox

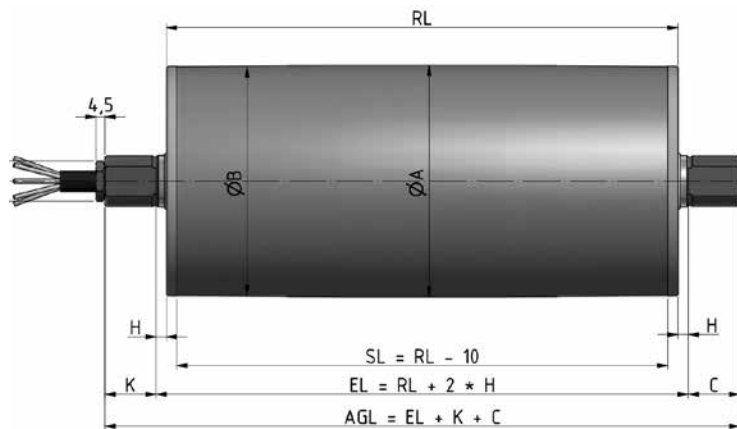

Drum motor with straight connector in stainless steel

Drum shell shape	ØA [mm]	ØB [mm]
Crowned	113.0	111.5
Cylindrical	112.0	112.0
Cylindrical with key	113.0	113.0

Shaft dimension	Width across flats [mm]	H [mm]	K [mm]	C [mm]
Ø25mm	20	5	25	25
Ø35mm	21	3	20	20

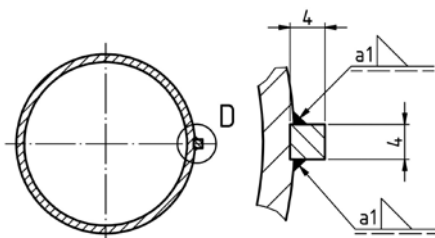

Drum motor with key 4x4

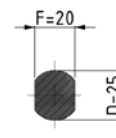

Standard shaft



Shaft cap

DRUM MOTOR 113LS

113.0Ø 0.035kW - 0.55kW, with steel helical gearbox

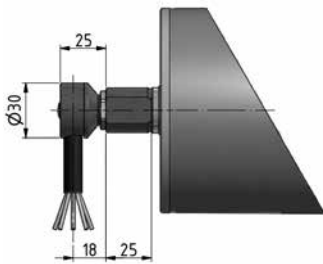

Elbow connector in stainless steel

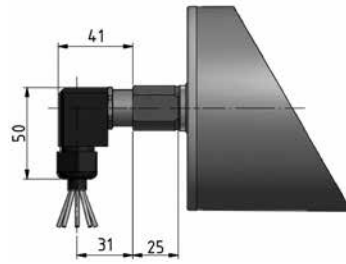

Elbow connector in polyamide

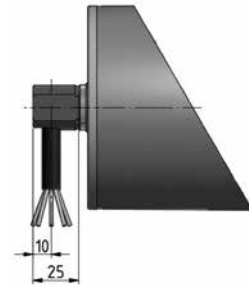

Cable slot 90° with threaded shaft

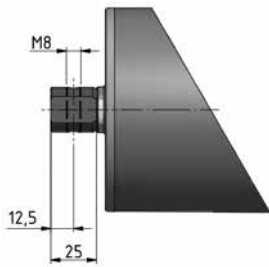

Cross-drilled and threaded shaft

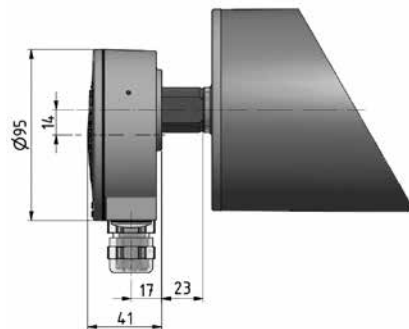

Terminal box in aluminium

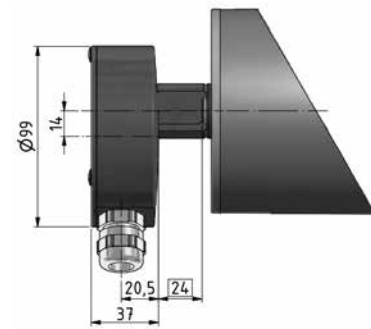

Terminal box in stainless steel

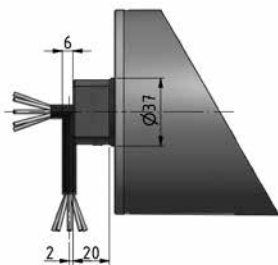

Shaft cap Uni in stainless steel

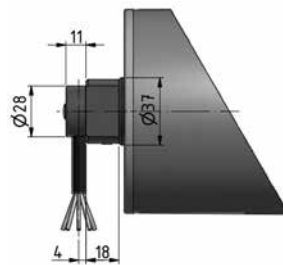

Elbow connector with shaft cap in stainless steel

DRUM MOTOR 138LS

138.5Ø 0.10kW - 1.00kW, with steel helical gearbox

Product description

The drum motor 138LS is a very flexible component thanks to the wide range of powers and speeds.

Characteristics

- Salt water resistant aluminum bearing housing
- Three phase AC induction motor
- Dual voltage
- Integral motor protection
- Steel- hardened helical spur gear
- Low noise operation
- Maintenance free
- Lifetime lubrication
- Reversible operation
- Reinforced shaft for RL greater than 800 mm

Applications

- Conveyors for heavy and frequent use
- Conveyors for transportation of packages
- Logistics applications
- Check-in desks at airports
- Conveyors for furniture manufacture
- Manufacturing of food processes
- Modular belts, steel or plastic applications
- Dry, damp and frequent wash down applications

TECHNICAL DATA

Motor Data

Type of Motor	Asynchronous squirrel-cage, IEC 34 (VDE 0530)
Insulation class of motor windings	Class F, IEC 34 (VDE 0530)
Derated windings (20% power reduction)	On request for applications without belt
Voltage	230/400 V ± 5% (IEC 34/38) Special voltage on request
Frequency	50/60 Hz
Internal shaft sealing system	Double-lipped FPM or nitrile rubber, NBR
Protection rate	IP66, IP69 in TS8N Version
Thermal protection	Bimetallic Contact
Ambient temperature, 3-phase motor	-25 to +40 °C
General technical data	
Max. Roller length (RL)	1800 mm

All data and values declared in the catalogue refer to operation with a frequency of 50 Hz.



DRUM MOTOR 138LS

138.5Ø 0.10kW - 1.00kW, with steel helical gearbox

Materials

The following drum motor components are available in different versions, as shown in the below chart, with further options for the material type as indicated.

Components	Version	Material				
		Aluminium	Steel	Stainless Steel	Brass /Nickel	Polymer
Shell	Crowned		Std	TS8N		
	Cylindrical		Std	TS8N		
	Cylindrical + key (for sprockets)		Std	TS8N		
	Special crowns and grooves		Std	TS8N		
End housing	Standard	Std		TS8N		
	With V-grooves		Std	TS8N		
	With O-grooves		Std	TS8N		
	With chain sprockets		Std	TS8N		
Shaft	Standard		Std	TS8N		
	Cross-drilled and threaded, M8		Std	TS8N		
Electrical connection	Straight connector			TS8N	Std	
	Elbow connector			TS8N		Std
	Terminal box	Std		TS8N		

Please contact Rulmeca for further versions.

TS8N Version - End Caps in stainless steel with PTFE lip seals.

Options

- Rubber Lagging for standard belts
- Profiled lagging for plastic modular belts
- Profiled lagging for thermoplastic belts
- Sprockets for plastic modular belts
- Backstop / Anti run-back bearing
- Electromagnetic brake
- Rectifiers
- Encoder
- Food-grade Oil (EU, FDA and USDA)
- Non-horizontal mounting
(more than $\pm 5^\circ$)
- TS8N with mild steel shell is possible
- Dynamic balancing

Note

The combination of encoder and electromagnetic brake is not possible.

Accessories

- Mounting brackets
- Idler Pulleys
- Rollers for conveyors
- Frequency Converters

DRUM MOTOR 138LS

138.5Ø 0.10kW - 1.00kW, with steel helical gearbox

TECHNICAL DATA DRUM MOTOR 138LS - 3PHASE - 50HZ - STANDARD

P_N [kW]	np (rpm)	I_t [A]	gs	i	V_A [m/s]	V_N [m/s]	n_A [min ⁻¹]	M_N [Nm]	F_T [N]	TE [N]	RL [mm]	
0.10	12 (440)	1.3/0.75	3	78.40	0.04	0.04	6	162	2360	8300	min 300 max 1800	
				66.00	0.05	0.05	7	136	1987			
			52.96	0.06	0.06	8	109	1594				
			2	29.56	0.11	0.10	15	61	890			
0.18	8 (670)	2.0/1.15	3	66.00	0.07	0.08	10	160	2331	8300	min 300 max 1800	
				52.96	0.09	0.10	13	128	1870			
				43.65	0.11	0.13	15	106	1542			
			2	29.56	0.16	0.16	23	72	1044	4850		
				25.20	0.19	0.20	26	61	890			
				66.00	0.10	0.10	14	156	2280			
0.24	6 (920)	1.55/0.9	3	52.96	0.12	0.13	17	125	1830	8300	min 300 max 1800	
				43.65	0.15	0.16	21	103	1508			
				29.56	0.22	0.20	31	70	1021			
			2	25.20	0.26	0.25	36	60	871	4850		
				20.22	0.33	0.32	45	48	699			
				6	935	2.25/1.3	3	51.85	0.13			0.13
0.37	4 (1400)	2.1/1.2	3	66.00	0.15	0.16	21	158	2310	4850	min 300 max 1800	
				52.96	0.19	0.20	26	127	1854			
				43.65	0.23	0.25	32	105	1528			
			2	29.56	0.34	0.32	47	71	1035			
				25.20	0.40	0.40	55	60	882			
				20.22	0.50	0.50	68	48	708			
				16.67	0.60	0.63	83	40	583			
				12.44	0.81	0.80	111	30	435			3650
0.55	2 (2730)	2.3/1.3	3	77.41	0.25	0.25	35	141	2065	4850	min 300 max 1800	
				66.00	0.30	0.32	41	121	1761			
				52.96	0.37	0.40	51	97	1413			
				43.65	0.45	0.50	62	80	1165			
			2	29.56	0.66	0.63	91	54	789	3650		
				25.20	0.78	0.80	107	46	672			
				20.22	0.97	1.00	134	37	539			
				16.67	1.17	1.25	162	30	445			
				12.44	1.57	1.60	217	23	332			
				38.72	0.25	0.25	35	193	2818			4850
32.59	0.30	0.32	41	162	2371							
25.20	0.39	0.40	54	126	1834							
20.22	0.48	0.50	67	101	1471							
0.75	4 (1365)	3.6/2.1	3	16.67	0.59	0.63	81	83	1213	3650		
				25.20	0.81	0.80	112	60	880			
				20.22	1.01	1.00	139	48	706			
			2	16.67	1.22	1.25	169	40	582			
				12.44	1.64	1.60	226	30	434			
				43.65	0.46	0.50	64	141	2057		4850	min 350 max 1800
32.59	0.68	0.63	94	95	1393							
25.20	0.80	0.80	110	81	1188							
20.22	1.00	1.00	137	65	953							
1.0	2 (2810)	4.1/2.35	3	16.67	1.21	1.25	167	54	786	3650		
				12.44	1.62	1.60	223	40	586			
			2	10.00	2.02	2.00	278	32	471			

DRUM MOTOR 138LS

138.5Ø 0.10kW - 1.00kW, with steel helical gearbox

TECHNICAL DATA DRUM MOTOR 138LS - 3PHASE - 50HZ - DERATED

P_N [kW]	np (rpm)	I_f [A]	gs	i	V_A [m/s]	V_N [m/s]	n_A [min ⁻¹]	M_N [Nm]	F_T [N]	TE [N]	RL [mm]
0.21	6 (930)	1.15/0.65	3	66.00	0.10	0.10	13.9	135	1974	8300	min 300 max 1800
				52.96	0.13	0.13	17.4	108	1584		
				43.65	0.15	0.16	21.1	89	1305		
			2	29.56	0.23	0.20	31.1	61	884	4850	
				25.20	0.26	0.25	36.5	52	754		
				20.22	0.33	0.32	45.5	41	605		
0.31	4 (1380)	1.4/0.8	3	66.00	0.15	0.16	20.7	134	1964	4850	min 300 max 1800
				52.96	0.19	0.20	25.8	108	1576		
				43.65	0.23	0.25	31.3	89	1299		
			2	29.56	0.33	0.32	46.2	60	879	3650	
				25.20	0.39	0.40	54.2	51	750		
				20.22	0.49	0.50	67.5	41	602		
				16.67	0.59	0.63	81.9	34	496		
				12.44	0.80	0.80	109.7	25	370		
0.45	2 (2740)	1.7/1.0	3	77.41	0.25	0.25	35.0	115	1684	4850	min 300 max 1800
				66.00	0.30	0.32	41.1	98	1436		
				52.96	0.37	0.40	51.2	79	1152		
				43.65	0.45	0.50	62.1	65	949		
			2	29.56	0.66	0.63	91.7	44	643	3650	
				25.20	0.78	0.80	107.6	38	548		
				20.22	0.97	1.00	134.0	30	440		
				16.67	1.18	1.25	162.6	25	363		
				12.44	1.58	1.60	217.9	19	271		
0.62	4 (1415)	2.7/1.55	3	38.72	0.26	0.25	36.1	154	2247	4850	min 320 max 1800
				32.59	0.31	0.32	42.9	130	1891		
			2	25.20	0.40	0.40	55.5	100	1462		
				20.22	0.50	0.50	69.2	80	1173		
				16.67	0.61	0.63	84.0	66	967		

Derated motors are used in applications, where standard windings tend to overheat, typically in applications with no belt as modular belting, in hot environments or when thick lagging is required on shell. To gain the full benefit of the deration, the drum motor has to be operated close to or at full load. Derated motors should not be used together with Frequency Converters. In case of doubts Rulmeca offers technical support to order the optimal motor setup for the application.

P_N Nominal mechanical power
 np Number of poles
 rpm Actual rotor rpm at full load
 I_f Amperage (230/400V) at full load
 gs Gear stages
 i Gear ratio
 V_A Theoretical actual belt (tangential) speed at full load*
 V_N Nominal belt (tangential) speed
 n_A Revolutions of shell at full load*

M_N Nominal Torque at full load
 F_T Belt pull (tangential force) on shell at full load*
 TE T1 + T2 maximum allowable belt tension (radial load)
 RL Reference length
 * Valid for unlagged shells/ values can deviate at partly or no load conditions

DRUM MOTOR 138LS

138.5Ø 0.10kW - 1.00kW, with steel helical gearbox

STANDARD WEIGHT DATA DRUM MOTOR 138LS

P _N	np	Standard weight [kg] for standard RL [mm]													
		300	320	350	400	450	500	550	600	650	700	750	800	900	1000
0.10	12	14.0	14.5	15.0	16.0	17.0	18.0	19.0	20.0	21.5	23.0	24.0	25.0	27.0	29.0
0.18	8	14.0	14.5	15.0	16.0	17.0	18.0	19.0	20.0	21.5	23.0	24.0	25.0	27.0	29.0
0.24	6	14.0	14.5	15.0	16.0	17.0	18.0	19.0	20.0	21.5	23.0	24.0	25.0	27.0	29.0
0.37	6	---	15.0	15.6	16.5	17.5	18.5	19.5	20.5	22.0	23.5	24.5	25.5	27.5	29.5
	4	14.0	14.5	15.0	16.0	17.0	18.0	19.0	20.0	21.5	23.0	24.0	25.0	27.0	29.0
0.55	2	14.0	14.5	15.0	16.0	17.0	18.0	19.0	20.0	21.5	23.0	24.0	25.0	27.0	29.0
0.75	4	---	15.0	15.6	16.5	17.5	18.5	19.5	20.5	22.0	23.5	24.5	25.5	27.5	29.5
	2	---	---	18.0	19.0	20.0	21.0	22.0	23.0	24.5	26.0	27.0	28.0	30.0	32.0
1.0	2	---	---	18.0	19.0	20.0	21.0	22.0	23.0	24.5	26.0	27.0	28.0	30.0	32.0
idler (UT138LS)	-	6.5	7.0	7.5	8.5	9.5	10.5	11.5	12.5	13.5	14.5	15.5	16.5	19.5	21.5

Cable specification

Available cable options:

- Standard, screened
- Standard, unscreened
- Halogen-free, screened
- Halogen-free, unscreened

Available lengths: 1/3/5 m.

Min. length with option

The following options increase the minimum length of the drum motor

Option	RL min with option mm
Brake	RL min. + 50 mm
Encoder SKF	RL min. + 0 mm
Encoder RLS	RL min. + 50 mm

DRUM MOTOR 138LS

138.5Ø 0.10kW - 1.00kW, with steel helical gearbox

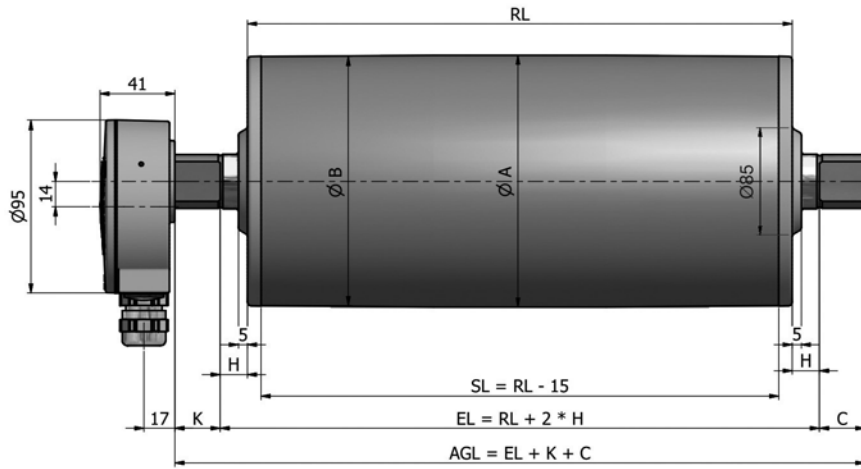

Drum motor with terminal box in aluminium

Drum shell shape	ØA [mm]	ØB [mm]
Crowned	138.5	137.0
Cylindrical	137.0	137.0
Cylindrical with key	137.0	137.0

Shaft dimension	Width across flats [mm]	H [mm]	K [mm]	C [mm]
Ø30mm	20.0	15.0	27.0	25.0

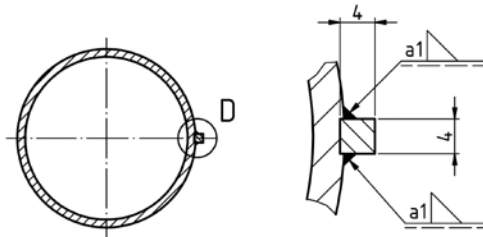

Drum motor with key 4x4

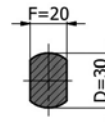

Standard shaft

DRUM MOTOR 138LS

138.5Ø 0.10kW - 1.00kW, with steel helical gearbox

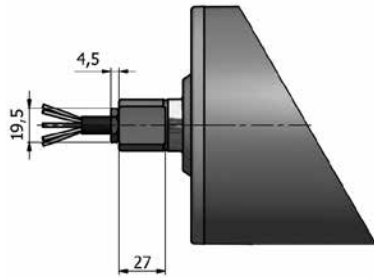

Straight connector in brass or stainless steel

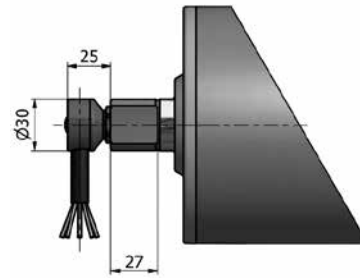

Elbow connector in stainless steel

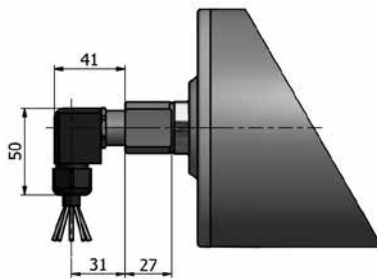

Elbow connector in polyamide

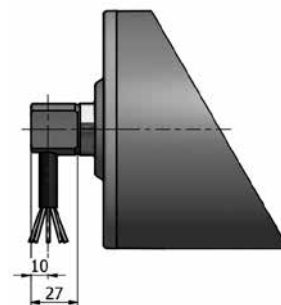

Cable slot 90° with threaded shaft

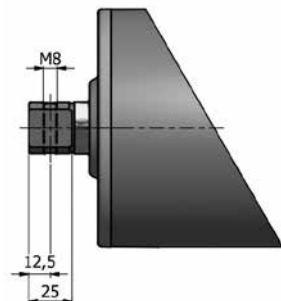

Cross-drilled and threaded shaft

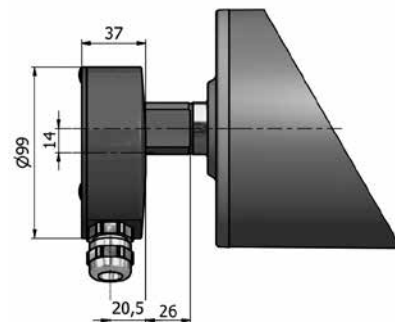

Terminal box in stainless steel

DRUM MOTOR 165LS

165.0Ø 0.11kW - 2.20kW, with steel helical gearbox

Product description

The drum motor 165LS is able to provide high torques and withstand high radial loads.

Characteristics

- Salt water resistant aluminum bearing housing
- Three phase AC induction motor
- Dual voltage
- Integral motor protection
- Steel- hardened helical spur gear
- Low noise operation
- Maintenance free
- Lifetime lubrication
- Reversible operation

Applications

- Conveyors for heavy and frequent use
- Logistics applications
- Airport and postal conveyors
- Warehouse loading conveyors
- Telescopic conveyors
- Agricultural plants
- Manufacturing of food processes
- Modular belts, steel or plastic applications
- Dry, damp and frequent wash applications

TECHNICAL DATA

Motor Data

Type of Motor	Asynchronous squirrel-cage, IEC 34 (VDE 0530)
Insulation class of motor windings	Class F, IEC 34 (VDE 0530)
Derated windings (20% power reduction)	On request for applications without belt
Voltage	230/400 V ± 5% (IEC 34/38) Special voltage on request
Frequency	50/60 Hz
Internal shaft sealing system	Double-lipped FPM or nitrile rubber, NBR
Protection rate	IP66, IP69 in TS8N Version
Thermal protection	Bimetallic Contact
Ambient temperature, 3-phase motor	-25 to +40 °C
General technical data	
Max. Roller length (RL)	2000 mm

All data and values declared in the catalogue refer to operation with a frequency of 50 Hz.



DRUM MOTOR 165LS

165.0Ø 0.11kW - 2.20kW, with steel helical gearbox

Materials

The following drum motor components are available in different versions, as shown in the below chart, with further options for the material type as indicated.

Components	Version	Material				
		Aluminium	Steel	Stainless Steel	Brass /Nickel	Polymer
Shell	Crowned		Std	TS8N		
	Cylindrical		Std	TS8N		
	Cylindrical + key (for sprockets)		Std	TS8N		
	Special crowns and grooves		Std	TS8N		
End housing	Standard	Std		TS8N		
	With V-grooves		Std	TS8N		
	With O-grooves		Std	TS8N		
	With chain sprockets		Std	TS8N		
Shaft	Standard		Std	TS8N		
	Cross-drilled and threaded, M10		Std	TS8N		
Electrical connection	Straight connector			TS8N	Std	
	Elbow connector			TS8N		Std
	Terminal box	Std		TS8N		

Please contact Rulmeca for further versions.

TS8N Version - End Caps in stainless steel with PTFE lip seals.

Options

- Rubber Lagging for standard belts
- Profiled lagging for plastic modular belts
- Profiled lagging for thermoplastic belts
- Sprockets for plastic modular belts
- Backstop / Anti run-back bearings
- Electromagnetic brake
- Rectifiers
- Encoder
- Food-grade Oil (EU, FDA and USDA)
- Non-horizontal mounting (more than $\pm 5^\circ$)
- Dual speed motor
- Version TS7N - as TS8N but with re-greasable labyrinth seals

Note

The combination of encoder and electromagnetic brake is not possible.

Accessories

- Mounting brackets
- Idler Pulleys
- Rollers for conveyors
- Frequency Converters

DRUM MOTOR 165LS

165.0Ø 0.11kW - 2.20kW, with steel helical gearbox

TECHNICAL DATA DRUM MOTOR 165LS - 3PHASE - 50HZ - STANDARD

P_N [kW]	np (rpm)	I_f [A]	gs	i	V_A [m/s]	V_N [m/s]	n_A [min ⁻¹]	M_N [Nm]	F_T [N]	TE [N]	RL [mm]	
0.11	12 (470)	1.7/0.98	3	75.03	0.05	0.05	6	159	1934	11000	min 400 max 2000	
				61.56	0.07	0.06	8	131	1587			
			49.75	0.08	0.08	9	106	1282				
			2	37.93	0.11	0.10	12	81	978			
0.37	6 (920)	2.35/1.35	3	75.03	0.11	0.10	12	274	3323	19000	min 400 max 2000	
				61.56	0.13	0.13	15	225	2727			
				49.75	0.16	0.16	18	182	2203			
	4 (1375)	1.9/1.1	3	61.56	0.19	0.20	22	150	1824	11000	min 350 max 2000	
				49.75	0.24	0.25	28	121	1474			
				37.93	0.31	0.32	36	93	1124			
			2	30.05	0.39	0.40	46	73	891			
				23.76	0.50	0.50	58	58	704			
				19.20	0.62	0.63	72	47	569			
				14.64	0.81	0.80	94	36	434			
11.60	1.02	1.00	119	28	344	7600						
0.75	6 (945)	4.65/2.7	3	46.23	0.18	0.16	20	333	4041	19000	min 400 max 2000	
				61.56	0.20	0.20	23	298	3619			
	4 (1405)	3.5/2.0	3	49.75	0.24	0.25	28	241	2925	11000	min 400 max 2000	
				37.93	0.32	0.32	37	184	2230			
				30.05	0.40	0.40	47	146	1767			
				23.76	0.51	0.50	59	115	1397			
			2	19.20	0.63	0.63	73	93	1129			
				14.64	0.83	0.80	96	71	861			
				11.60	1.04	1.00	121	56	682			7600
				1.10	4 (1420)	4.7/2.7	3	46.23	0.26			0.25
37.93	0.32	0.32	37					267	3236			
2 (2830)	4.1/2.35	3	61.56		0.40	0.40	46	217	2635	7600		
			49.75		0.49	0.50	57	175	2130			
			37.93		0.64	0.63	75	134	1624			
			30.05		0.81	0.80	94	106	1286			
		2	23.76		1.03	1.00	119	84	1017			
			19.20		1.27	1.25	147	68	822			
			14.64		1.67	1.60	193	52	627			
			11.60		2.10	2.00	244	41	497			
9.43	2.59	2.50	300	33	404							

P_N Nominal mechanical power
 np Number of poles
 rpm Actual rotor rpm at full load
 I_f Amperage (230/400V) at full load
 gs Gear stages
 i Gear ratio

V_A Theoretical actual belt (tangential) speed at full load*
 V_N Nominal belt (tangential) speed
 n_A Revolutions of shell at full load*
 M_N Nominal Torque at full load
 F_T Belt pull (tangential force) on shell at full load*

TE T1 + T2 maximum allowable belt tension (radial load)
 RL Reference length
 * Valid for unlagged shells / values can deviate at partly or no load conditions

DRUM MOTOR 165LS

165.0Ø 0.11kW - 2.20kW, with steel helical gearbox

TECHNICAL DATA DRUM MOTOR 165LS - 3PHASE - 50HZ - STANDARD

P_N [kW]	np (rpm)	I_f [A]	gs	i	V_A [m/s]	V_N [m/s]	n_A [min ⁻¹]	M_N [Nm]	F_T [N]	TE [N]	RL [mm]	
1.50	2 (2850)	5.8/3.35	3	46.23	0.53	0.50	62	221	2680	11000	min 400 max 2000	
				37.93	0.65	0.63	75	181	2199			
				30.05	0.82	0.80	95	143	1742			
			2	23.76	1.03	1.00	120	113	1377	7600		
				19.20	1.28	1.25	148	92	1113			
				14.64	1.68	1.60	195	70	849			
				11.60	2.12	2.00	246	55	672			
				9.43	2.61	2.50	302	45	547			
				7.80	3.15	3.15	365	37	452			7100
				7.80	3.15	3.15	365	37	452			7100
2.20	2 (2860)	8.15/4.7	3	46.23	0.53	0.50	62	323	3916	11000	min 430 max 2000	
				37.93	0.65	0.63	75	265	3213			
				30.05	0.82	0.80	95	210	2546			
				24.43	1.01	1.00	117	170	2070			
				20.21	1.22	1.25	142	141	1712			
			2	14.64	1.69	1.60	195	102	1240	7600		
				11.60	2.13	2.00	247	81	983			
				9.43	2.62	2.50	303	66	799			
				7.80	3.16	3.15	367	54	661			7100
				7.80	3.16	3.15	367	54	661			7100

 P_N Nominal mechanical power**np** Number of poles**rpm** Actual rotor rpm at full load **I_f** Amperage (230/400V) at full load**gs** Gear stages**i** Gear ratio **V_A** Theoretical actual belt (tangential) speed at full load* **V_N** Nominal belt (tangential) speed **n_A** Revolutions of shell at full load* **M_N** Nominal Torque at full load **F_T** Belt pull (tangential force) on shell at full load***TE** T1 + T2 maximum allowable belt tension (radial load)**RL** Reference length

* Valid for unlagged shells / values can deviate at partly or no load conditions

DRUM MOTOR 165LS

165.0Ø 0.11kW - 2.20kW, with steel helical gearbox

STANDARD WEIGHT DATA DRUM MOTOR 165LS

P _N	np	Standard weight [kg] for standard RL [mm]													
		350	400	450	500	550	600	650	700	750	800	850	900	950	1000
0.11	12	---	30.0	31.5	33.0	34.0	35.0	36.0	37.5	39.0	40.0	41.0	42.5	44.0	45.0
0.37	6	---	30.0	31.5	33.0	34.0	35.0	36.0	37.5	39.0	40.0	41.0	42.5	44.0	45.0
	4	26.0	28.0	29.5	31.0	32.0	33.0	34.0	35.5	37.0	38.0	39.0	40.5	42.0	43.0
0.75	6	---	33.0	34.5	36.0	37.0	38.0	39.0	40.5	42.0	43.0	44.0	45.5	47.0	48.0
	4	---	31.0	32.5	34.0	35.0	36.0	37.0	38.5	40.0	41.0	42.0	43.5	45.0	46.0
1.10	4	---	34.0	35.5	37.0	38.0	39.0	40.0	41.5	43.0	44.0	45.0	46.5	48.0	49.0
	2	---	33.0	34.5	36.0	37.0	38.0	39.0	40.5	42.0	43.0	44.0	45.5	47.0	48.0
1.50	2	---	34.0	35.5	37.0	38.0	39.0	40.0	41.5	43.0	44.0	45.0	46.5	48.0	49.0
2.20	2	---	37.0	37.5	38.0	39.0	40.0	41.0	42.5	44.0	45.0	46.0	47.5	49.0	50.0
idler (UT165LS)	-	12.5	14.0	15.5	17.0	18.5	20.0	21.5	23.0	24.5	26.0	27.5	29.0	30.5	32.0

Cable specification

Available cable options:

- Standard, screened
- Standard, unscreened
- Halogen-free, screened
- Halogen-free, unscreened

Available lengths: 1/3/5 m.

Min. length with option

The following options increase the minimum length of the drum motor

Option	RL min with option mm
Brake	RL min. + 50 mm
Encoder SKF	RL min. + 0 mm
Encoder RLS	RL min. + 50 mm

DRUM MOTOR 165LS

165.0Ø 0.11kW - 2.20kW, with steel helical gearbox

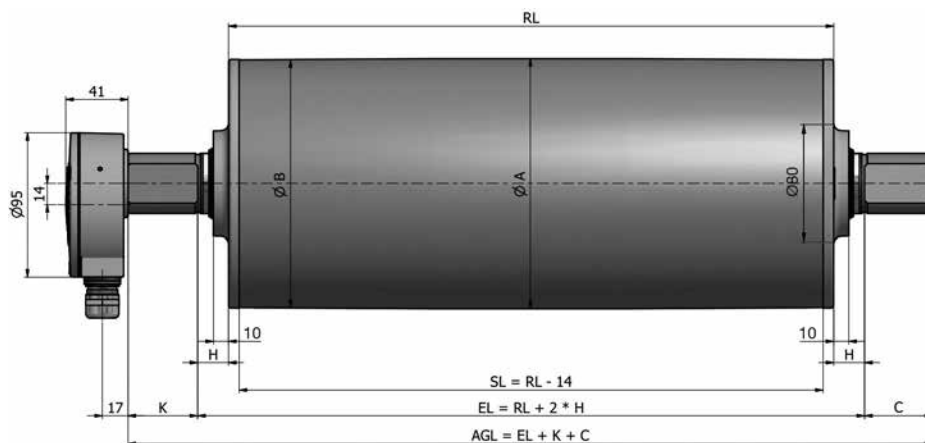

Drum motor with terminal box in aluminium

Drum shell shape	ØA [mm]	ØB [mm]	Shaft dimension	Width across flats [mm]	H [mm]	K [mm]	C [mm]
Crowned	165.0	163.5	Ø40mm	30.0	20.0	47.0	45.0
Cylindrical	164.75	164.75					
Cylindrical with key	162.0	162.0					

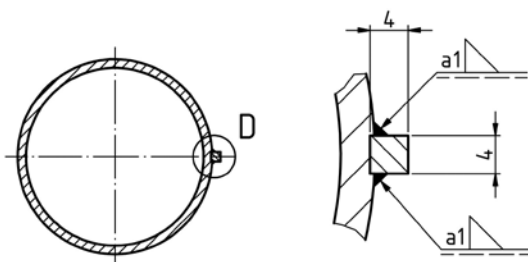

Drum motor with key 4x4

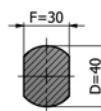

Standard shaft

DRUM MOTOR 165LS

165.0Ø 0.11kW - 2.20kW, with steel helical gearbox

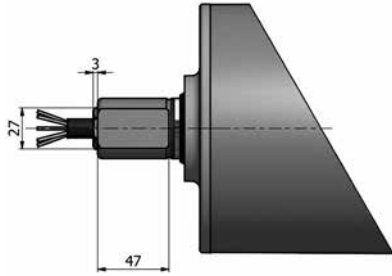

Straight connector in brass or stainless steel

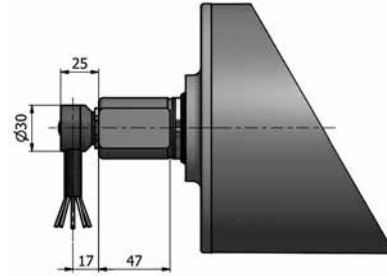

Elbow connector in stainless steel

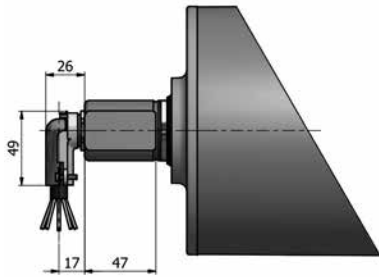

Elbow connector in aluminium

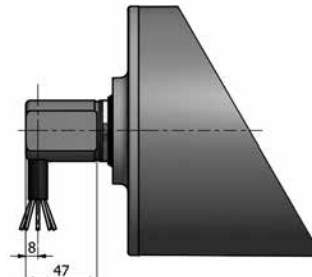

Cable slot 90° with threaded shaft

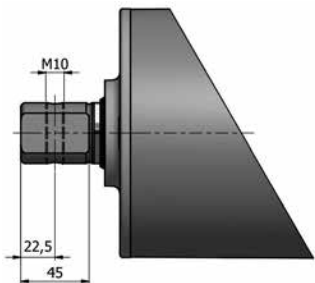

Cross-drilled and threaded shaft

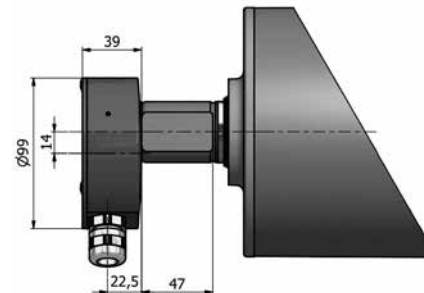

Terminal box in stainless steel

DRUM MOTOR 216LS

216.0Ø 0.11kW - 2.20kW, with steel helical gearbox

Product description

The drum motor 216LS is able to provide high torques and withstand high radial loads.

Characteristics

- Salt water resistant aluminum bearing housing
- Three phase AC induction motor
- Dual power supply
- Integral motor protection
- Steel- hardened helical spur gear
- Low noise operation
- Maintenance free
- Lifetime lubrication
- Reversible operation

Applications

- Conveyors for heavy and frequent use
- Logistics applications
- Airport and postal conveyors
- Warehouse loading conveyors
- Telescopic conveyors
- Agricultural plants
- Manufacturing of food processes
- Modular belts, steel or plastic applications
- Dry, damp and frequent wash applications

TECHNICAL DATA

Motor Data

Type of Motor	Asynchronous squirrel-cage, IEC 34 (VDE 0530)
Insulation class of motor windings	Class F, IEC 34 (VDE 0530)
Derated windings (20% power reduction)	On request for applications without belt
Voltage	230/400 V ± 5% (IEC 34/38) Special voltage on request
Frequency	50/60 Hz
Internal shaft sealing system	Double-lipped FPM or nitrile rubber, NBR
Protection rate	IP66
Thermal protection	Bimetallic Contact
Ambient temperature, 3-phase motor	-25 to +40 °C
General technical data	
Max. Roller length (RL)	2000 mm

All data and values declared in the catalogue refer to operation with a frequency of 50 Hz.

DRUM MOTOR 216LS

216.0Ø 0.11kW - 2.20kW, with steel helical gearbox

Materials

The following drum motor components are available in different versions, as shown in the below chart, with further options for the material type as indicated.

Components	Version	Material				
		Aluminium	Steel	Stainless Steel	Brass /Nickel	Polymer
Shell	Crowned		Std	TS8N		
	Cylindrical		Std	TS8N		
	Cylindrical + key (for sprockets)		Std	TS8N		
	Special crowns and grooves		Std	TS8N		
End housing	Standard	Std		TS8N		
	With V-grooves		Std	TS8N		
	With O-grooves		Std	TS8N		
	With chain sprockets		Std	TS8N		
Shaft	Standard		Std	TS8N		
	Cross-drilled and threaded, M10		Std	TS8N		
Electrical connection	Straight connector			TS8N	Std	
	Elbow connector			TS8N		Std
	Terminal box	Std		TS8N		

Please contact Rulmeca for further versions.

TS8N Version - End Caps in stainless steel with PTFE lip seals.

Options

- Rubber Lagging for standard belts
- Profiled lagging for plastic modular belts
- Backstop / Anti run-back bearings
- Electromagnetic brake
- Rectifiers
- Encoder
- Food-grade Oil (EU, FDA and USDA)
- Non-horizontal mounting (more than $\pm 5^\circ$)
- Version TS7N - as TS8N but with re-greasable labyrinth seals

Note

The combination of encoder and electromagnetic brake is not possible.

Accessories

- Mounting brackets
- Idler Pulleys
- Rollers for conveyors
- Frequency Converters

DRUM MOTOR 216LS

216.0Ø 0.11kW - 2.20kW, with steel helical gearbox

TECHNICAL DATA DRUM MOTOR 216LS - 3PHASE - 50HZ - STANDARD

P_N [kW]	np (rpm)	I_L [A]	gs	i	V_N [m/s]	V_A [m/s]	n_n [min ⁻¹]	M_N [Nm]	F_T [N]	TE [N]	RL [mm]	
0.11	12 (470)	1.7/0.98	3	75.03	0.07	0.07	6	159	1475	19000	min 400 max 2000	
				61.56	0.09	0.09	8	131	1210			
				49.75	0.11	0.11	9	106	978			
			2	37.93	0.14	0.14	12	81	746			
0.37	6 (920)	2.35/1.35	3	75.03	0.14	0.14	12	274	2535	19000	min 400 max 2000	
				61.56	0.16	0.17	15	225	2080			
				49.75	0.20	0.21	18	182	1681			
	4 (1375)	1.9/1.1	3	61.56	0.25	0.25	22	150	1391	11000	min 350 max 2000	
				49.75	0.32	0.31	28	121	1125			
				37.93	0.40	0.41	36	93	857			
				30.05	0.50	0.52	46	73	679			
				23.76	0.63	0.65	58	58	537			
				19.20	0.80	0.81	72	47	434			
			2	14.64	1.10	1.06	94	36	331	7600		
				11.60	1.25	1.34	119	28	262			
				11.60	1.25	1.34	119	28	262			
0.75	6 (945)	4.65/2.7	3	46.23	0.20	0.23	20	333	3082	11000	min 400 max 2000	
				61.56	0.25	0.26	23	298	2760			
	4 (1405)	3.5/2.0	3	49.75	0.32	0.32	28	241	2231	11000		
				37.93	0.40	0.42	37	184	1701			
				30.05	0.50	0.53	47	146	1347			
				23.76	0.63	0.67	59	115	1065			
				19.20	0.80	0.83	73	93	861			
				14.64	1.10	1.09	96	71	656			
			2	11.60	1.25	1.37	121	56	520	7600		
				46.23	0.32	0.35	31	325	3008			11000
				37.93	0.40	0.42	37	267	2468			
	1.10	4 (1420)	4.7/2.7	3	61.56	0.50	0.52	46	217	2010		11000
49.75					0.63	0.64	57	175	1624			
2 (2830)		4.1/2.35	3	37.93	0.80	0.84	75	134	1238	11000		
				30.05	1.10	1.07	94	106	981			
				23.76	1.25	1.35	119	84	776			
				19.20	1.60	1.67	147	68	627			
				14.64	2.00	2.19	193	52	478			
				11.60	2.50	2.76	244	41	379			
			2	9.43	3.15	3.39	300	33	308	7600		

DRUM MOTOR 216LS

216.0Ø 0.11kW - 2.20kW, with steel helical gearbox

TECHNICAL DATA DRUM MOTOR 216LS - 3PHASE - 50HZ - STANDARD

P_N [kW]	np (rpm)	I_f [A]	gs	i	V_N [m/s]	V_A [m/s]	n_A [min ⁻¹]	M_N [Nm]	F_T [N]	TE [N]	RL [mm]
1.50	2 (2850)	5.8/3.35	3	46.23	0.63	0.70	62	221	2044	11000	min 400 max 2000
				37.93	0.80	0.85	75	181	1677		
				30.05	1.10	1.07	95	143	1329		
			2	23.76	1.25	1.36	120	113	1050	7600	
				19.20	1.60	1.68	148	92	849		
				14.64	2.00	2.20	195	70	647		
				11.60	2.50	2.78	246	55	513		
				9.43	3.15	3.42	302	45	417		
				7.80	4.00	4.13	365	37	345		
				7.80	4.00	4.13	365	37	345		
2.20	2 (2860)	8.15/4.7	3	46.23	0.63	0.70	62	323	2987	11000	min 430 max 2000
				37.93	0.80	0.85	75	265	2451		
				30.05	1.00	1.08	95	210	1942		
				24.43	1.25	1.32	117	170	1579		
			2	20.21	1.60	1.60	142	141	1306	7600	
				14.64	2.00	2.21	195	102	946		
				11.60	2.50	2.79	247	81	750		
				9.43	3.15	3.43	303	66	609		
				7.80	4.00	4.15	367	54	504		
				7.80	4.00	4.15	367	54	504		

P_N Nominal mechanical power
 np Number of poles
 rpm Actual rotor rpm at full load
 I_f Amperage (230/400V) at full load
 gs Gear stages
 i Gear ratio
 V_A Theoretical actual belt (tangential) speed at full load*
 V_N Nominal belt (tangential) speed
 n_A Revolutions of shell at full load*

M_N Nominal Torque at full load
 F_T Belt pull (tangential force) on shell at full load*
 TE T1 + T2 maximum allowable belt tension (radial load)
 RL Reference length
 • Valid for unlagged shells / values can deviate at partly or no load conditions

STANDARD WEIGHT DATA DRUM MOTORS & IDLERS 216LS

P_N [kW]	np	Standard weight [kg] for standard RL [mm]													
		350	400	450	500	550	600	650	700	750	800	850	900	950	1000
0.11	12	---	38.5	41.5	44.5	47.5	50.5	53.5	56.5	59.5	62.5	65.5	68.5	71.5	74.5
0.37	6	---	39.5	42.5	45.5	48.5	51.5	54.5	57.5	60.5	63.5	66.5	69.5	72.5	75.5
	4	34.5	37.5	40.5	43.5	46.5	49.5	52.5	55.5	58.5	61.5	64.5	67.5	70.5	73.5
0.75	6	---	42.5	45.5	48.5	51.5	54.5	57.5	60.5	63.5	66.5	69.5	72.5	75.5	78.5
	4	---	40.5	43.5	46.5	49.5	52.5	55.5	58.5	61.5	64.5	67.5	70.5	73.5	76.5
1.10	4	---	43.5	46.5	49.5	52.5	55.5	58.5	61.5	64.5	67.5	70.5	73.5	76.5	79.5
	2	---	42.5	45.5	48.5	51.5	54.5	57.5	60.5	63.5	66.5	69.5	72.5	75.5	78.5
1.50	2	---	43.5	46.5	49.5	52.5	55.5	58.5	61.5	64.5	67.5	70.5	73.5	76.5	79.5
2.20	2	---	46.5	49.5	52.5	55.5	58.5	61.5	64.5	67.5	70.5	73.5	76.5	79.5	82.5
idler	-	12.5	14	15.5	17	18.5	20	21.5	23	24.5	26	27.5	29	30.5	32

DRUM MOTOR 216LS

216.0Ø 0.11kW - 2.20kW, with steel helical gearbox

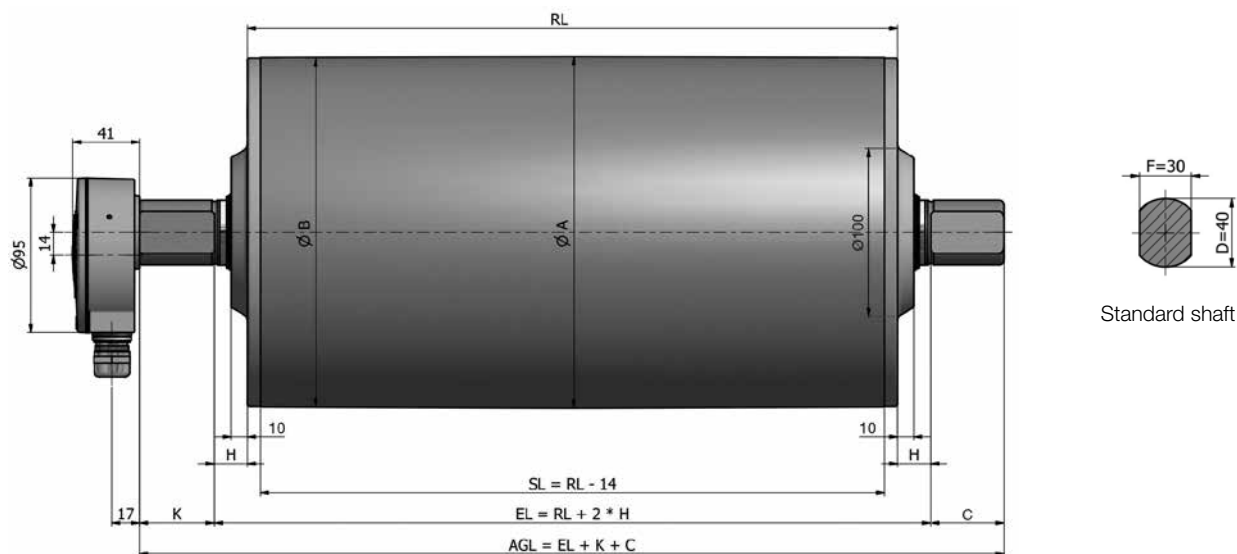

Drum motor with terminal box in aluminium

Drum shell shape	ϕA [mm]	ϕB [mm]
Crowned	216.0	214.5
Cylindrical	216.0	216.0

Shaft dimension	Width across flats [mm]	H [mm]	K [mm]	C [mm]
$\phi 40$ mm	30.0	20.0	47.0	45.0

DRUM MOTOR 216LS

216.0Ø 0.11kW - 2.20kW, with steel helical gearbox

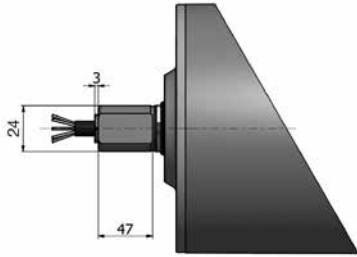

Straight connector in brass or stainless steel

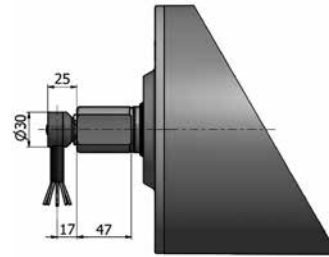

Elbow connector in stainless steel

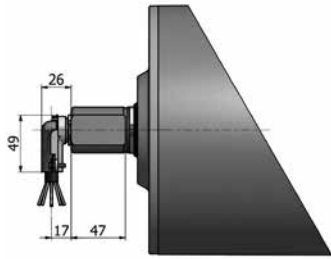

Elbow connector in aluminium

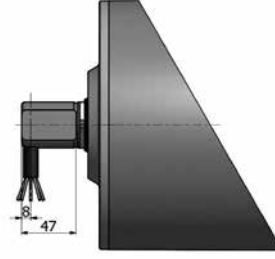

Cable slot 90° with threaded shaft

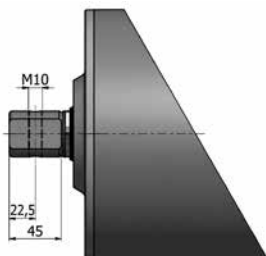

Cross-drilled and threaded shaft

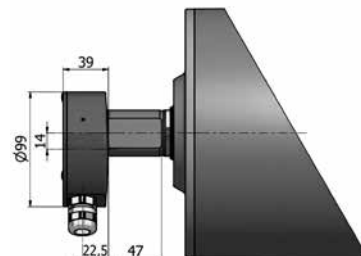

Terminal box in stainless steel

DRUM MOTOR 220M-H

216.0Ø 0.37kW - 5.5kW, with steel helical gearbox

Product description

Drum motor very robust able to provide high torques and withstand high radial loads

Characteristics

- Salt water resistant aluminum bearing housing
- Induction motor three phases alternating current
- Dual voltage
- Integral motor protection
- Steel- hardened helical spur gear
- Low noise operation
- Maintenance free
- Lifetime lubrication
- Reversible operation

Applications

- Conveyors for heavy and frequent use
- Logistics applications
- Airport and postal conveyors
- Warehouse loading conveyors
- Telescopic conveyors
- Agricultural plants
- Manufacturing of food processes
- Modular belts, steel or plastic applications
- Dry, damp and frequent wash down applications

TECHNICAL DATA

Motor Data

Type of Motor	Asynchronous squirrel-cage, IEC 34 (VDE 0530)
Insulation class of motor windings	Class F, IEC 34 (VDE 0530)
Voltage	230/400 V ± 5% (IEC 34/38) Special voltage on request
Frequency	50/60 Hz
Internal shaft sealing system	Double-lipped FPM or nitrile rubber, NBR
Protection rate	IP66
Thermal protection	Bimetallic Contact
Ambient temperature, 3-phase motor	-25 to +40 °C

General technical data

Max. Roller length (RL)	2000 mm
-------------------------	---------

All data and values declared in the catalogue refer to operation with a frequency of 50 Hz.



DRUM MOTOR 220M-H

216.0Ø 0.37kW - 5.5kW, with steel helical gearbox

Materials

The following drum motor components are available in different versions, as shown in the below chart, with further options for the material type as indicated.

Components	Version	Material				
		Aluminium	Steel	Stainless Steel	Brass /Nickel	Polymer
Shell	Crowned		Std	TS10N		
	Cylindrical		Std	TS10N		
	Cylindrical + key (for sprockets)		Std	TS10N		
	Special crowns and grooves		Std	TS10N		
End housing	Standard	Std		TS10N		
	With V-grooves		Std	TS10N		
	With O-grooves		Std	TS10N		
	With chain sprockets		Std	TS10N		
Shaft	Standard		Std	TS10N		
	Cross-drilled and threaded, M10		Std	TS10N		
Electrical connection	Straight connector			TS10N	Std	
	Elbow connector			TS10N		Std
	Terminal box	Std		TS10N		

Please contact Rulmeca for further versions.

TS10N Version - End Housing in stainless steel with NBR lip seals.

Options

- Rubber Lagging for standard belts
- Profiled Lagging for plastic modular belts
- Backstop /Anti run-back bearing
- Dynamic balancing
- Electromagnetic brake
- Rectifiers
- Encoder
- Food-grade Oil (EU, FDA and USDA)
- Non-horizontal mounting (more than $\pm 5^\circ$)
- Version TS9N - as TS10N but with re-greasable labyrinth seals

Note

The combination of encoder and electromagnetic brake is not possible.

Accessories

- Mounting brackets
- Idler Pulleys
- Rollers for conveyors
- Frequency Converters

DRUM MOTOR 220M-H

216.0Ø 0.37kW - 5.5kW, with steel helical gearbox

TECHNICAL DATA FOR DRUM MOTOR 220M/H - 3PHASE - 50HZ

P_N [kW]	n_p (rpm)	I_T [A]	gs	i	V_A [m/s]	V_N [m/s]	n_A [min ⁻¹]	M_N [Nm]	F_T [N]	TE [N]	RL [mm]
0.37	8 (705)	1.75	3 (220H)	59.72	0.13	0.13	11.8	291	2707	25000	min 450 max 2000
				49.84	0.16	0.16	14.1	236	2195		
			2 (220M)	37.49	0.21	0.20	18.8	190	1767	11500	min 400 max 2000
				29.62	0.27	0.25	23.8	152	1414		
				24.17	0.33	0.32	29.2	118	10989		
				20.17	0.40	0.40	35.0	95	884		
				15.84	0.50	0.50	44.5	76	707		
				12.74	0.63	0.63	55.3	60	558		
				9.77	0.82	0.80	72.2	47	437		
				8.10	0.98	1.00	87.0	38	353		
6.36	1.25	1.25	110.8	30	279						
0.55	8 (710)	2.75	3 (220H)	59.72	0.13	0.13	11.9	432	4019	25000	min 500 max 2000
				49.84	0.16	0.16	14.2	351	3265		
			2 (220M)	37.49	0.21	0.20	18.9	282	2623	11500	min 450 max 2000
				29.62	0.27	0.25	24.0	226	2102		
				24.17	0.33	0.32	29.4	176	1637		
				20.17	0.40	0.40	35.2	141	1312		
				15.84	0.51	0.50	44.8	113	1051		
				12.74	0.63	0.63	55.7	89	828		
				9.77	0.82	0.80	72.7	70	651		
				8.10	0.99	1.00	87.7	56	521		
6.36	1.26	1.25	111.6	45	419						
0.75	8 (690)	3.40	3 (220H)	59.72	0.13	0.13	11.6	592	5510	25000	min 500 max 2000
				49.84	0.16	0.16	13.8	481	4476		
			2 (220M)	37.49	0.21	0.20	18.4	385	3581	11500	min 450 max 2000
				29.62	0.26	0.25	23.3	307	2856		
				24.17	0.32	0.32	28.5	239	2223		
				20.17	0.39	0.40	34.2	191	1777		
				15.84	0.49	0.50	43.6	153	1423		
				12.74	0.61	0.63	54.2	122	1135		
				9.77	0.80	0.80	70.6	96	893		
				8.10	0.96	1.00	85.2	77	716		
6.36	1.23	1.25	108.5	62	577						
1.10	6 (950)	3.60	3 (220H)	59.72	0.18	0.16	15.9	705	6558	25000	min 500 max 2000
	4 (1420)	2.70		49.84	0.22	0.20	19.1	564	5246		
		59.72		0.27	0.25	23.8	452	4205			
		49.84		0.32	0.32	28.5	353	3284			

DRUM MOTOR 220M-H

216.0Ø 0.37kW - 5.5kW, with steel helical gearbox

TECHNICAL DATA FOR DRUM MOTOR 220M/H - 3PHASE - 50HZ

P_N [kW]	n_p (rpm)	I_f [A]	gs	i	V_A [m/s]	V_N [m/s]	n_A [min ⁻¹]	M_N [Nm]	F_T [N]	TE [N]	RL [mm]						
1.10	4 (1420)	2.70	2 (220M)	37.49	0.43	0.40	37.9	282	2623	11500	min 450 max 2000						
				29.62	0.54	0.50	47.9	226	2102								
				24.17	0.66	0.63	58.8	178	1656								
				20.17	0.80	0.80	70.4	141	1312								
				15.84	1.01	1.00	89.6	112	1042								
				12.74	1.26	1.25	111.5	90	837								
				9.77	1.64	1.60	145.3	70	651								
				8.10	1.98	2.00	175.3	56	521								
1.50	4 (1420)	3.80	3 (220H)	59.72	0.27	0.25	23.9	646	5730	25000	min 450 max 2000						
				49.84	0.32	0.32	28.7	481	4476								
			2 (220M)	37.49	0.43	0.40	38.1	385	3581	11500	min 450 max 2000						
				29.62	0.54	0.50	48.3	307	2856								
				24.17	0.66	0.63	59.2	243	2260								
				20.17	0.80	0.80	70.9	191	1777								
				15.84	1.01	1.00	90.3	153	1423								
				12.74	1.26	1.25	112.2	123	1144								
				9.77	1.64	1.60	146.4	96	893								
				8.10	1.98	2.00	176.5	77	716								
				6.36	2.53	2.50	224.8	62	572								
				2.20	4 (1430)	5.60	3 (220H)	49.84	0.32			0.32	28.7	705	6558	2500	min 500 max 2000
								39.14	0.41			0.40	36.5	564	5246		
							2 (220M)	29.62	0.55			0.50	48.3	451	4195	11500	min 450 max 2000
								24.17	0.67			0.63	59.2	358	3330		
								20.17	0.80			0.80	70.9	282	2623		
15.84	1.02	1.00	90.3					226	2102								
12.74	1.27	1.25	112.2					180	1674								
9.77	1.66	1.60	146.4					140	1302								
8.10	2.00	2.00	176.5	115	1070												
6.36	2.54	2.50	224.8	90	837												

P_N Nominal mechanical power
 n_p Number of poles
rpm Actual rotor rpm at full load
 I_f Amperage (230/400V) at full load
gs Gear stages
i Gear ratio
 V_A Theoretical actual belt (tangential) speed at full load*
 V_N Nominal belt (tangential) speed
 n_A Revolutions of shell at full load*

M_N Nominal Torque at full load
 F_T Belt pull (tangential force) on shell at full load*
TE T1 + T2 maximum allowable belt tension (radial load)
RL Reference length
• Valid for unlagged shells / values can deviate at partly or no load conditions

DRUM MOTOR 220M-H

216.0Ø 0.37kW - 5.5kW, with steel helical gearbox

TECHNICAL DATA FOR DRUM MOTOR 220M/H - 3PHASE - 50HZ

P_N [kW]	np (rpm)	I_r [A]	gs	i	V_A [m/s]	V_N [m/s]	n_A [min ⁻¹]	M_N [Nm]	F_T [N]	TE [N]	RL [mm]
3.00	4 (1395)	7.20	3 (220H)	31.49	0.50	0.50	44.3	616	5730	25000	min 550 max 2000
				24.15	0.65	0.63	57.8	481	4476		
			2 (220M)	20.17	0.78	0.80	69.2	385	3581	11500	min 500 max 2000
				15.84	1.00	1.00	88.1	307	2856		
				12.74	1.24	1.25	109.5	245	2279		
				9.77	1.61	1.60	142.8	192	1786		
				8.10	1.95	2.00	172.2	154	1433		
6.36	2.48	2.50	219.3	123	1144						
4.00	2 (2820)	8.30	3 (220H)	49.84	0.64	0.63	56.6	649	6037	25000	min 550 max 2000
				39.14	0.82	0.80	72.0	511	4754		
			2 (220M)	29.62	1.08	1.00	95.2	409	3805	11500	min 500 max 2000
				24.17	1.32	1.25	116.7	327	3042		
				20.17	1.58	1.60	139.8	255	2372		
				15.84	2.01	2.00	178.0	204	1898		
				12.74	2.50	2.50	221.4	163	1516		
5.50	2 (2860)	10.60	3 (220H)	40.21	0.80	0.80	71.1	702	6530	25000	min 550 max 2000
				31.87	1.01	1.00	89.7	562	5228		
				25.80	1.25	1.25	110.9	450	4186		
				19.89	1.63	1.60	143.8	351	3265		
				15.56	2.08	2.00	183.8	281	2614		
				13.00	2.49	2.50	220.0	225	2093		

P_N Nominal mechanical power
 np Number of poles
 rpm Actual rotor rpm at full load
 I_r Amperage (230/400V) at full load
 gs Gear stages
 i Gear ratio
 V_A Theoretical actual belt (tangential) speed at full load*
 V_N Nominal belt (tangential) speed
 n_A Revolutions of shell at full load*

M_N Nominal Torque at full load
 F_T Belt pull (tangential force) on shell at full load*
 TE T1 + T2 maximum allowable belt tension (radial load)
 RL Reference length
 • Valid for unlagged shells / values can deviate at partly or no load conditions

DRUM MOTOR 220M-H

216.0Ø 0.37kW - 5.5kW, with steel helical gearbox

TECHNICAL DATA FOR DRUM MOTOR 220M/H - 3PHASE - 50HZ

Rated power [kW]	Poles n.	Gear stages n.	Standard weight [kg] for standard RL [mm]													
			400	450	500	550	600	650	700	750	800	850	900	950	1000	
0.37	8	3	---	64	67	70	73	76	79	82	85	88	91	94	97	
		2	48,0	51	54	57	60	63	66	69	72	75	78	81	84	
0.55	8	3	---	---	71	74	77	80	83	86	89	92	95	98	101	
		2	---	55	58	61	64	67	70	73	76	79	82	85	88	
0.75	8	3	---	---	71	74	77	80	83	86	89	92	95	98	101	
		2	---	55	58	61	64	67	70	73	76	79	82	85	88	
1.10	6	3	---	---	68	71	74	77	80	83	86	89	92	95	98	
		4	3	---	61	64	67	70	73	76	79	82	85	88	91	94
			2	46,0	49	52	55	58	61	64	67	70	73	76	79	82
1.50	4	3	---	61	64	68	71	74	77	80	83	86	89	92	95	
		2	48,0	51	54	57	60	63	66	69	72	75	78	81	84	
2.20	4	3	---	---	68	72	75	78	81	84	87	90	93	96	99	
		2	---	55	58	61	64	67	70	73	76	79	82	85	88	
3.00	4	3	---	---	---	74	77	80	83	86	89	92	95	98	101	
		2	---	---	60	63	66	69	72	75	78	81	84	87	90	
4.00	2	3	---	---	---	74	77	80	83	86	89	92	95	98	101	
		2	---	---	60	63	66	69	72	75	78	81	84	87	90	
5.50	2	3	---	---	---	74	77	80	83	86	89	92	95	98	101	
idler	...	UT 220M	25	27	29	31	33	35	37	39	41	43	45	47	49	
	...	UT 220H	---	29	31	33	35	37	39	41	43	45	47	49	51	

Cable specification

Available cable options:

- Standard, screened
- Standard, unscreened
- Halogen-free, screened
- Halogen-free, unscreened

Available lengths: 1 / 3 / 5 m.

Min.Length with option

The following options increase the minimum length of the drum motor.

Available lengths: 1 / 3 / 5 m.

Option	RL min. with option mm
Brake	RL min. + 50 mm
Encoder SKF	RL min. + 0 mm
Encoder RLS	RL min. + 50 mm

DRUM MOTOR 220M-H

216.0Ø 0.37kW - 5.5kW, with steel helical gearbox

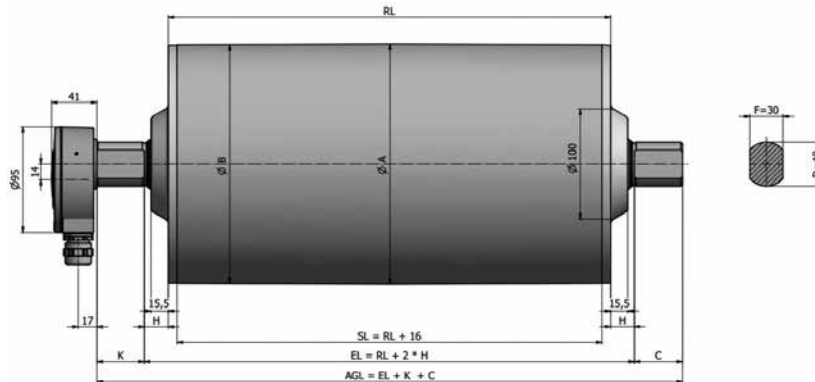

Drum motor standard version
with terminal box in aluminium $\leq 4,0$ kW

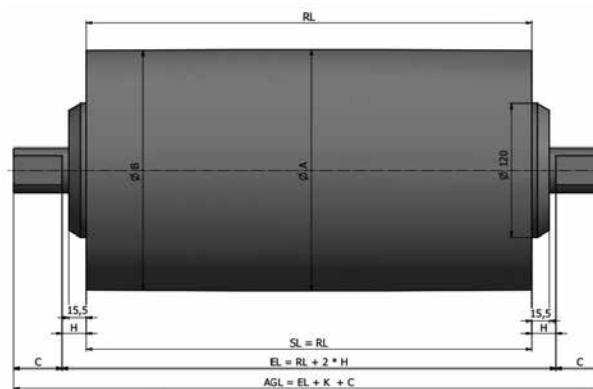

Idler Pulley in stainless steel (TS10N/TS12N)

Drum shell shape	ØA [mm]	ØB [mm]
Crowned	216.0	214.5
Cylindrical	216.0	216.0

Shaft dimension	Width across flats [mm]	H [mm]	K [mm]	C [mm]
Ø40mm	30.0	21.5	41.5	43.5

DRUM MOTOR 220M-H

216.0Ø 0.37kW - 5.5kW, with steel helical gearbox

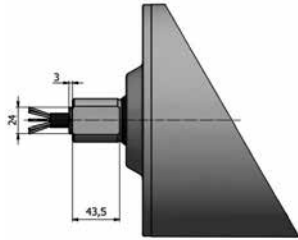

Straight connector in brass or stainless steel $\leq 4,0$ kW

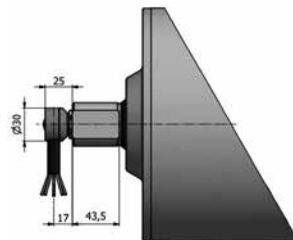

Elbow connector in stainless steel $\leq 4,0$ kW

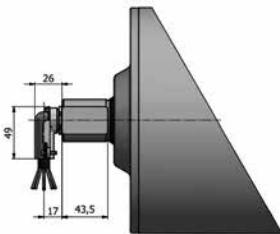

Elbow connector in aluminium $\leq 4,0$ kW

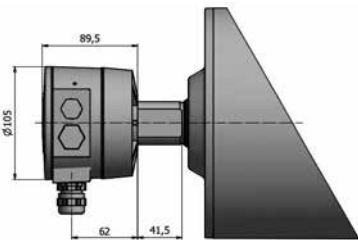

Large terminal Box $\geq 5,5$ kW

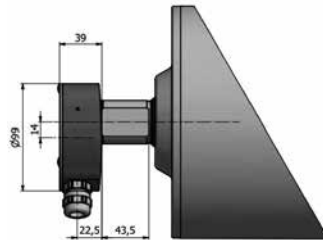

Terminal box in stainless steel $\leq 4,0$ kW

Type/Version	A mm	B mm	C mm	D mm	E mm	F mm	G mm	H mm	K mm	L mm	M mm	N mm	Q mm	T mm
Drum motor 220M-H standard version with terminal box in aluminium	216	214.5	43.5	40	100	30	15.5	21.5	41.5	41	17	95		14
Large terminal box									41.5	87	62	105		
Terminal box in stainless steel									41.5	37	20.5	99		14
Idler Pulley in stainless steel (TS10N/TS12N)					120				43.5					
Straight connector in brass or stainless steel									43.5	4		27		
Elbow connector in stainless steel									43.5	25	18	30		
Elbow connector in polyamide									43.5	39	29	50		

DRUM MOTOR 320-1000

Summary table

For further information on the below listed drum motors please consult our technical catalogue 'Motorized pulleys for belt conveyors bulk handling'.

Clas. mm	Power Kw	Type	Speed	Torque	Tangential force	Max belt tension mm	RL min	A	B	C	D	E	F	G	H	K
320	0.75	L	0.32-1.25	356-92	2218-573	11500	450	323	319	50	40	96	30	19.5	25	54
		M	0.16-0.80	712-142	4453-885	20000	500	125				22.5				
		H	0.13	876	5475	35000	550	50				148		40		
	1.1	L	0.63-2.50	265-67	1651-417	11500	400	323	319	50	40	96	30	19.5	25	54
		M	0.25-1.25	669-134	4181-835	20000	500	125				22.5				
		H	0.13-0.20	1286-836	8039-5225	35000	550	50				148		40		
	1.5	L	0.63-2.50	362-92	2255-573	11500	400	323	319	50	40	96	30	19.5	25	54
		M	0.25-1.25	912-182	5700-1134	20000	500	125				22.5				
		H	0.16-0.20	1425-1140	8906-7125	35000	550	50				148		40		
	2.2	L	0.80-2.50	418-134	2604-835	11500	450	323	319	50	40	96	30	19.5	25	54
		M	0.32-2.50	1045-134	6531-835	20000	500	125				22.5				
		H	0.20-0.25	1672-1338	10450-8362	35000	550	50				148		40		
	3	L	1.25-2.50	362-182	2255-1134	11500	500	323	319	50	40	96	30	19.5	25	54
		M	0.50-2.50	912-182	5700-1134	20000	500	125				22.5				
		H	0.25-0.40	1824-1140	11400-7125	35000	550	50				148		40		
	4	L	1.60-2.50	380-243	2368-1514	11500	500	323	319	50	40	96	30	19.5	25	54
		M	0.63-2.50	965-243	6031-1514	20000	500	125				22.5				
		H	0.32-0.50	1900-1216	11875-7600	35000	550	50				148		40		
	5.5	M	1.00-2.50	836-334	5225-2081	20000	550	321	319	50	40	125	30	22.5	25	54
		H	0.40-0.80	2090-1045	13062-6531	35000	500				50	148	40	20.5		
	7.5	M	1.60-2.50	712-456	4453-2850	20000	550	321	319	50	40	125	30	22.5	25	54
		H	0.80-1.25	1424-911	8909-5700	35000	500				50	148	40	20.5		
	11	M	2.5	671	4180	20000	1100	321	319	50	40	125	30	22.5	25	54
		H	1.00-2.00	1672-836	10450-5225	35000	1100				50	148	40	20.5		

DRUM MOTOR 320-1000

Clas. mm	Power Kw	Type	Speed	Torque	Tangential force	Max belt tension mm	RL min	A	B	C	D	E	F	G	H	K	
400	2.20	L	0.80÷2.50	522÷167	2584÷835	20000	500	404	400	50	40	125	30	20	25	54	
		M	0.32÷1.60	1306÷265	6465÷1325	40500	600				60	194	45	23		50	
		H	0.16÷0.25	2638÷1688	13062÷8360	50000	650										
	3.00	L	0.80÷2.50	712÷228	3562÷1140	20000	500				40	125	30	20		54	
		L	0.80÷2.50	950÷304	4750÷1520	20000	500				40	125	30	20		54	
	4.00	M	0.50÷1.60	1520÷475	7525÷2375	40500	600				60	194	45	23		50	
		H	0.25÷0.40	3070÷1919	15200÷9500	50000	650										
		L	1.25÷2.50	836÷418	4180÷2090	20000	500				40	125	30	20		54	
	5.50	M	0.80÷3.15	1306÷332	6465÷1659	40500	600				60	194	45	23		50	
		H	2638÷1675	2638÷1675	13063÷8294	50000	650										
		L	2.00÷3.15	712÷3.15	3525÷2238	20000	500				40	125	30	20		54	
	7.50	M	1.00÷3.15	1425÷452	7054÷2238	40500	600										
		H	0.50÷0.80	2878÷1799	14250÷8906	50000	710										
	11.00	M	1.60÷3.15	1306÷660	6465÷3265	40500	660				60	194	45	23		50	
		H	0.80÷1.25	2638÷1688	13063÷8360	50000	710										
15.00	M	2.00÷3.15	1439÷907	7125÷4523	40500	660											
	H	1.00÷1.60	2878÷1799	14250÷8906	50000	710											
500	2.20	L	0.40÷1.00	1306÷522	5224÷2088	35000	600	501	497	50	60	194	42	23	25	50	
		M	0.20÷0.32	2613÷1633	10542÷6532	42200	650										
	4.00	L	0.63÷2.00	1508÷475	6032÷1900	35000	600										
		M	0.32÷0.50	2969÷1900	11876÷7600	42200	650										
	5.50	L	1.00÷3.15	1306÷424	5214÷1696	35000	600										
		M	0.50÷0.80	6212÷1632	10448÷6528	42200	650										
	7.50	H	0.50÷2.50	2612÷522	10427÷2084	46000	750				-	65	192	-	95	-	-
		L	1.25÷3.15	1425÷570	5700÷22870	35000	600				50	60	194	42	23	25	50
		M	0.63÷1.00	2827÷1781	11308÷7124	42200	710										
	11.00	H	0.63÷2.50	2827÷712	11285÷2843	46000	750				-	65	192	-	95	-	-
		L	2.00÷3.15	1306÷829	5224÷3316	35000	660				50	60	194	42	23	25	50
	15.00	M	1.00÷1.60	2612÷1633	10448÷6532	42200	710										
		H	1.00÷2.50	2611÷1045	10423÷4172	46000	750				-	65	192	-	95	-	-
		L	2.50÷3.15	1425÷1131	5700÷4524	35000	660				50	60	194	42	23	25	50
	18.50	M	1.25÷2.00	2850÷1782	11400÷7128	42200	710										
H		1.00÷3.15	3644÷1131	14450÷4515			-	65	192	-	95	-	-				
22.00	H	1.25÷3.15	3596÷1395	14356÷5569			-	65	192	-	95	-	-				
	H	1.60÷3.15	3444÷1600	13750÷6385			-	65	192	-	95	-	-				
30.00	H	1.60÷4.00	4236÷1901	16977÷7618			850	521	417	-	65	235	-	95	-	-	

DRUM MOTOR 320-1000

Clas. mm	Power Kw	Type	Speed	Torque	Tangential force	Max belt tension mm	RL min	A	B	C	D	E	F	G	H	K			
630	5.50	M	0.63÷3.15	2612÷522	8292÷1657	46000	750	630	626	-	65	192	-	95	-	-			
	7.50	M	0.80÷3.15	2805÷712	8905÷2261					-			-						
	11.00	M	1.25÷3.15	2631÷1045	8356÷3318					-			-						
	15.00	M	1.60÷3.15	2804÷1424	8902÷4521					-			-						
	18.50	M	2.00÷3.15	2767÷1757	8784÷5578					-			-						
	22.00	M	2.00÷3.15	3222÷2090	10450÷6635	73600	950			-	-	-	-	-	-	-	-		
		H	1.00÷3.15	6583÷2089	20899÷6632					-	-	-	-	-	-	-	-	-	
	30.00	H	1.25÷3.15	7179÷2894	22791÷9045					98100	-	-	-	-	-	-	-	-	-
	37.00	H	1.60÷3.15	6920÷3513	21969÷11153						-	90	268	-	84	-	-	-	
	45.00	H	2.50÷4.00	5384÷3365	17092÷10683						-	-	-	-	-	-	-	-	
55.00	H	2.50÷4.00	6584÷4113	20902÷13057	88300	-	-	-	-	-	-	-	-	-					
800	22.0	M	1.25÷3.15	6688÷2653	16720÷6630	73600	950	800	796	-	90	268	-	88	-	-			
	30.0	M	1.60÷3.15	7122÷3617	17805÷9043	-				-									
	37.0	M	2.00÷4.00	7030÷3513	17575÷8783	-				-									
	45.0	M	3.15÷4.00	5426÷4273	13565÷10683	88300				-			-		-	-	-	-	
		M	3.15÷4.00	6584÷5223	14581÷13058					-			-		-	-	-	-	-
	55.0	H	1.60÷4.50	13052÷4644	32630÷11610	1150	-			-	-	-	-	-	-				
		HD	1.00÷1.25	20884÷16707	54974÷41300	1300	-			-	-	-	-	-	-				
	75.0	H	2.00÷4.50	14244÷6331	35610÷15828	200000	1150			-	-	-	-	-	-	-			
		HD	1.25÷1.60	22527÷18496	56318÷46240		1300			-	-	-	-	-	-	-			
	90.0	H	2.50÷4.50	13674÷7597	34185÷18993	180000	1400			120	330	-	80	-	-	-			
	HD	1.60÷2.00	21181÷18496	52.953÷46.240	1550		-	-	-			-		-	-				
110.0	H	3.15÷4.50	13264÷9265	33160÷26163	1400	-	-	-	-			-	-	-					
	HD	2.00÷2.50	21915÷17994	54789÷44984	1550	-	-	-	-			-	-	-					
132.0	H	4.00÷4.50	12535÷11142	31338÷27855	1400	-	-	-	-			-	-	-					
	HD	2.50÷3.15	21592÷15153	53981÷37882	1550	-	-	-	-			-	-	-					
1000	160	HD	2.50÷5.50	30300÷14000	59400÷27400	1400	1400	1020	1014			-	203	520	-	145	-	-	
	200	HD	2.50÷5.50	37900÷17600	74300÷34500	300000						1450			-		-	-	-
	250	HD	2.50÷5.50	47400÷22000	92900÷43100	1500						-			-		-	-	-

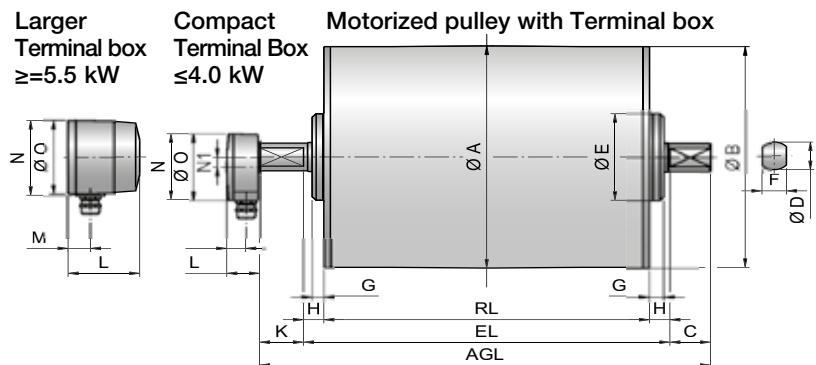



LIGHT INDUSTRIAL
DRUM MOTOR RANGE

INDUSTRIAL
DRUM MOTOR RANGE

OPTIONS

ACCESSORIES

PLANNING SECTION

OPTIONS

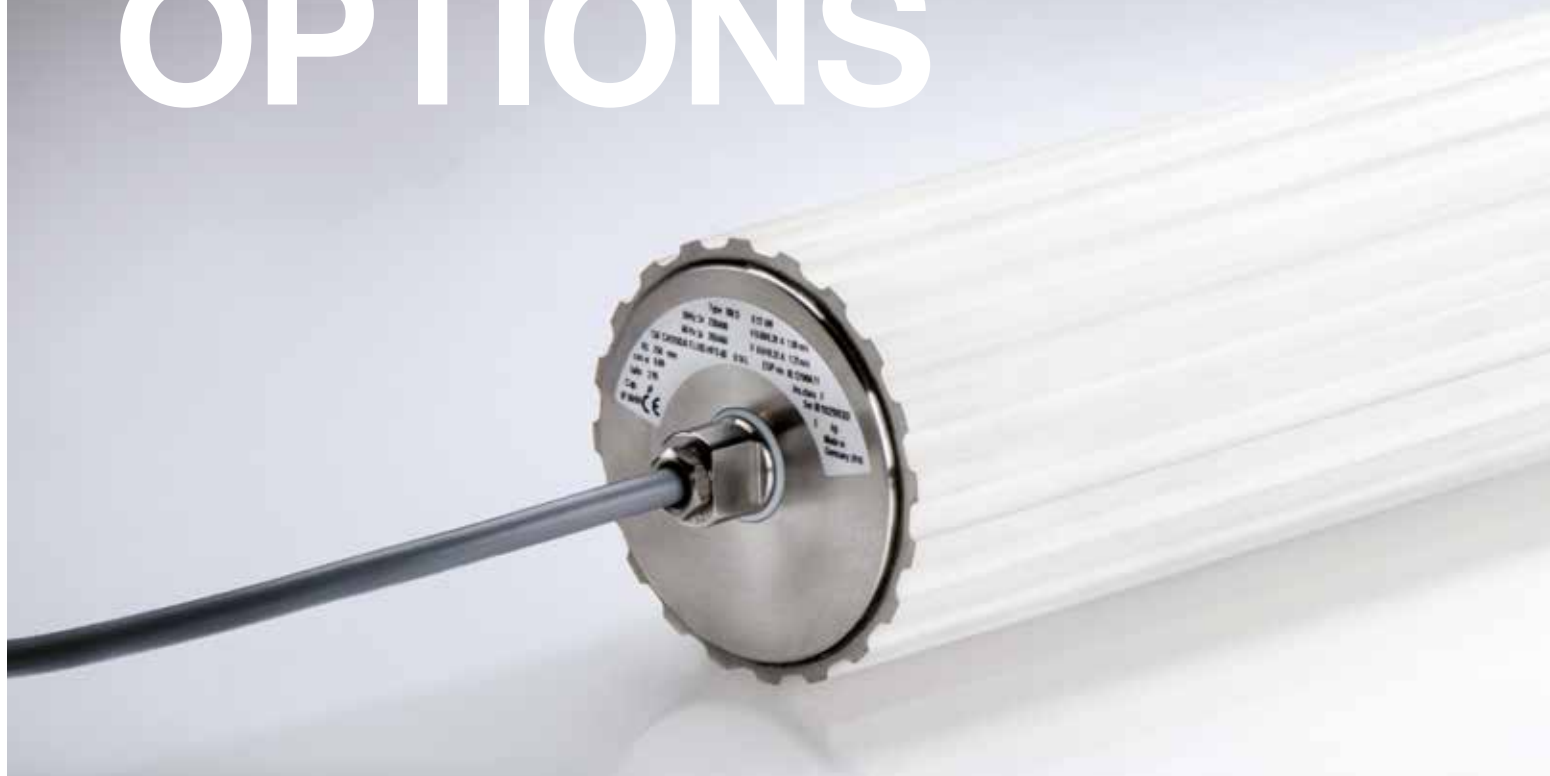



LAGGING FOR STANDARD BELTS

Smooth or specially grooved lagging to increase friction between the shell and conveyor belt

Product description

Characteristics

- High resistance to oil, fuel and other chemicals
- Increases friction between the shell of the drum motor and conveyor belt
- Prevents slip between the shell of the drum motor and conveyor belt
- Longitudinal grooved lagging reduces liquid build up between belt and shell
- Centered V-groove for belt tracking
- Multiple V-grooves for V-belt or round belt conveyors

Applications

- Wet applications
- For standard drum motors
- Food and hygienic applications
- Flat belt, round belt or multi V-belt applications
- Hot vulcanisation for high-torque drum motors

Note: The Lagging influences the outer diameter of the drum motor and increases its speed to that stated in the catalogue. The tangential force and the speed of the drum motor must be recalculated according to the increased diameter.

COLD VULCANIZATION LAGGING (R)

Lagging profile	Colour	Characteristics	Shore Hardness	Thickness mm
Smooth (S)	Black (B)	Oil and Fat resistant	70 ± 5 Shore A	3, 5, 6, 8, 10, 12
	White (W)	FDA food approved	70 ± 5 Shore A	
Longitudinal grooves (Ri)	White (W)	FDA food approved	70 ± 5 Shore A	8
Diamond Patterned (DP)	Black (B)	Oil and Fat resistant	60 ± 5 Shore A	8

HOT VULCANIZATION LAGGING (VR OR XN)

Lagging profile	Colour	Characteristics	Shore Hardness	Thickness mm
Smooth (S)	Black (B)	Oil and Fat resistant	65 ± 5 Shore A	3, 5, 6, 8, 10, 12, 14
	White (W)	FDA food approved	70 ± 5 Shore A	
	Blue (BL)	FDA food approved	70 ± 5 Shore A	
Longitudinal grooves (Ri)	Black (B)	Oil and Fat resistant	65 ± 5 Shore A	6, 8, 10, 12, 14
	White (W)	FDA food approved	70 ± 5 Shore A	
	Blue (BL)	FDA food approved	70 ± 5 Shore A	
Diamond Patterned (DP)	Black (B)	Oil and Fat resistant	65 ± 5 Shore A	6, 8

For a short description of the type of lagging.

Example:

R3 / S - W

| | | White
 | | | Smooth
 | | | 3mm thickness
 | | | Cold Vulcanisation

LAGGING FOR STANDARD BELTS

V-groove section - Smooth and specially grooved lagging to increase friction between the shell and conveyor belt

V-groove

Hot Vulcanization

A machined centre groove in the hot vulcanized rubber coating, allows the use of conveyor belts manufactured with a tracking profile on the underside of the belt. Designed to help maintain tracking and to prevent belt wander. Conveyors using this type of belt should be designed in such a way that the slider bed or roller bed primarily tracks the belt and not the drum motor.

Fig.: V-grooved lagging

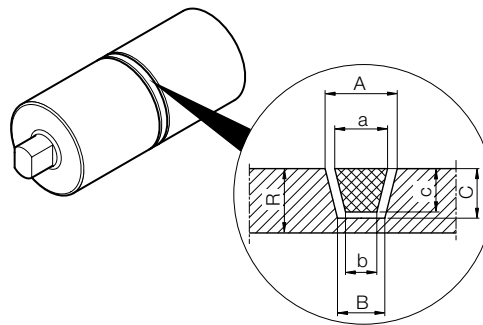

Groove	R Standard mm	R Stainless steel	Groove			Belt		
			A	B	C	a	b	c
K6	8	5	10	8	5	6	4	4
K8	8	6	12	8	6	8	5	5
K10	10	8	14	10	7/8*	10	6	6
K13	12	10	17	11	9/10*	13	7.5	8
K15	12	10	19	13	9/10*	15	9.5	8
K17	14	12	21	13	12	17	9.5	11

* for shell in stainless steel.

All dimensions are expressed in mm.

Rule:

- 1) R-C ≥ 2 for shell in steel
- 2) R=C for shell in stainless steel

Example for the groove description:

Central Groove K6

or for non standard measures:

Groove 11/8 x 5 Central

A/B x C

PROFILED LAGGING FOR PLASTIC MODULAR BELTS

Specially produced lagging, profiled to suit the belt manufacturers series of plastic modular belt

Product description

Characteristics

- Resistance to abrasion
- Low noise during operation
- Reduced wear of the belt
- Easy to clean
- High resistance to oil, grease and chemicals applications

Applications

- Applications for food environments
- Profiles to suit most manufacturer's standard plastic modular belts
- Drum motor with de-rated motors
- For standard drum motor with frequency converters. The frequency converter must be prepared to reduce the power by 18%

Note: The Lagging influences the outer diameter of the drum motor and increases its speed to that stated in the catalogue. The tangential force and the speed of the drum motor must be recalculated according to the increased diameter.

TECHNICAL DATA

Material	Hot Vulcanized nitrile rubber NBR
Lagging temperature	-40 /+120 °C (consider the temperature allowed for the drum motor)
Shore Hardness	From 65 to 70 ± 5 Shore A

Plastic modular belts manufacturer	Type Series	80LS	113LS	138LS	165LS
		Z	Z	Z	Z
Scanbelt	S.25 - 800		16	20	
	S.25 - 801		9		
	S.50 - 100 & 600			11	
	S.50 - 800		9	11	
Intralox	800		9	10	12
	1100 FG PE/AC	20	27		
	1100 FG PP		26		
	1100 FT PP		27		38
	1100 FT PE/AC	20	26	32	
			27		
1600	13	16	20	23	
Ammeraal/Uni-Chains	HDS62000		9	10	
	S-MPB	12	16	20	
				21	
	CNB		16	20	
	UNI QNB		16		
MPB/ECB		9	10	12	
Forbo Siegling	Series 6.1		9	10	13
				11	
HABASIT	M1220	24			
	M2510	12	16		23
	M5010		9	10	12

SPROCKETS FOR PLASTIC MODULAR BELTS

Special laser cut sprockets based on the specification of modular belt manufacturers

Product description

Characteristics

- Laser cut for excellent fitting accuracy
- Stainless steel sprockets to avoid rust
- Low friction

Applications

- For the control of plastic modular belts
- For standard drum motors with frequency converters. The frequency converter should be prepared to reduce the power by 18%
- For drum motors with de-rated motor
- For drum motors with cylindrical shell and locking key
- For food processing applications

Note: The Sprockets influence the outer diameter of the drum motor and increases its speed to that stated in the catalogue. The tangential force and the speed of the drum motor must be recalculated according to the increased diameter. Please refer to the velocity factor (Vf) in the table below.

Characteristics

Different belt variants and materials may affect the operational characteristics. Rulmeca try to show the most popular basic profile options in this catalogue. If you are unable to find the required profiled lagging or sprocket you need, or if you have some doubts, please answer the following questions and send them to Rulmeca with your enquiry:

- Lagging or sprockets preferred?
- Thermoplastic non-modular belt or plastic modular belt?
- drum motor diameter?
- Required belt speed?
- Belt manufacturer?
- Belt series?
- Belt type and variant?
- Belt material?
- Number of teeth?
- Tooth Pitch?
- Reversible, yes or no?
- Outside diameter (D) in mm?
- Pitch circle diameter (PCD) in mm?
- Sprocket thickness (B) in mm?

Product description

Drum motor that require sprockets, must be ordered with a cylindrical shell.

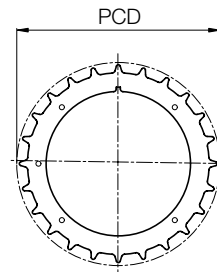

- Z** Number of teeth
- PCD** Pitch circle diameter in mm
- Vf** Velocity factor
- B** Width of sprocket in mm
- Rev.** Reversible sprocket
- Ref. no.** Reference number

Modular belt manufacturer	Series	Sprocket 80LS				113LS				Sprocket 138LS				165LS			
		Z	PCD mm	Vf	B mm	Z	PCD mm	Vf	B mm	Z	PCD mm	Vf	B mm	Z	PCD mm	Vf	B mm
Intralox	800	8	133.00	1.63	6.00	10	164.00	1.45	6.00								
	1100	24	116.00	1.42	18.00												
		24	116.00	1.42	6.00												
	1600	14	114.00	1.40	8.00												
	2400	15	122.00	1.49	6.00	19	154.00	1.36	6.00	24	195.00	1.42	6.00	26	211.00	1.30	6.00
HabasitLINK	M1220	25	101.00	1.24	3.00												
	M2520 & M2530	15	122.00	1.49	12.00												
		15	122.00	1.49	4.00	20	164.00	1.45	4.00								
Uni Chains / Ammeraal	Flex SNB	14	114.00	1.40	3.00	18	146.00	1.29	3.00	21	170.00	1.24	3.00	24	195.00	1.20	3.00
	M-SNB & M-QNB	24	97.00	1.19	5.00												

BACKSTOP / ANTI RUN-BACK BEARING

Product description

Backstops prevent the roll-back of the belt and carried load in case of shutdown or lack of power supply.

Characteristics

- The backstop runs only in one direction
- Mounted on the rotor shaft, except for the 80LS
- Mounted in the end housing on the 80LS
- No need for an electrical connection
- Higher holding torque than an electromagnetic brake

Applications

- Single direction inclined belt conveyors
- For preventing run-back of the belt and load when the power supply is off

The rotational direction of the drum motor with backstop is indicated by an arrow on the end housing at the electrical connection side.

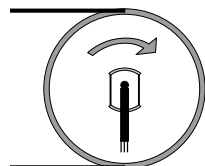

Fig.: Rotation arrow.

Product range

- Rotation direction from the electrical connector side
- Clockwise Anti-Clockwise

ELECTROMAGNETIC BRAKES

Product description

The Electromagnetic brake stops and holds the load in position according to the stated holding torque.

Characteristics

- Low noise
- Wear contained
- Powered by a separate external rectifier
- Applied directly on the rotor of the drum motor
- When the power to the motor is lost or stopped the brake will close (mechanically engage)

Applications

- For reversible inclined and declined conveyors
- For reduced stopping times*
- For stopping and holding loads
- For approximate positioning

(* For faster stopping times and accurate positioning, please use a frequency converter with braking function and if necessary an encoder with feedback control.

Response time

The response time for opening of the brake (drum motor start) and closing (stop drum motor), may vary substantially according to:

- Type and viscosity of the oil
- Level of oil in the drum motor
- Ambient temperature
- Internal motor working temperature
- Switching at input (AC-switching) or at output (DC-switching)
- Control contact of the coil brake into the alternating current supply of the rectifier (long response times), or on the output DC of the rectifier (fast response)
- Type and output voltage of the rectifier control of the brake coil

The difference between the control in alternating current and direct current is shown in the following table:

	AC Switching	DC Switching
Intervention time	Slow	Fast
Braking voltage	Nearly 1Volt	Nearly 500volt

Note: For the brake coil command in DC, the contacts must be protected against surges.

Reduction of braking torque

The declared braking torque M , is strongly influenced by the operating conditions of the drum motor (with oil at high temperatures) and the ambient temperature. For the calculation of the load that can be braked in safety, the braking torque provided in the tables should be reduced by 50%.

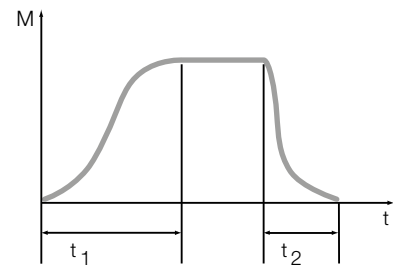

Fig.: Time t/Torque M brake closure

- t_1 Closing response time (de-excitation coil): Stop
- t_2 Opening response time (excitation coil): start

ELECTROMAGNETIC BRAKES

PRODUCT RANGE							
Drum motor	Rated torque M (Nm)	Rated power (W)	Rated voltage (V CC)	Rated current (A)	DC switching t1 (ms)	AC switching t1 (ms)	Opening delay time t2 (start) (ms)
80LS	1.1	12	24	0.5	13	80	20
			104	0.12	13	80	20
113LS 138LS	6	24	24	1.00	26	200	30
			104	0.23	26	200	30
			207	0.12	26	200	30
165LS	12	33	24	1.38	46	260	40
			104	0.32	46	260	40
			207	0.16	46	260	40

RECTIFIERS

The rectifier operates the electromagnetic brake

Product description

Characteristics

- The Rectifier for the electromagnetic brake (external component), must be installed in a protective box as close as possible to the drum motor

Applications

- Drum motor with electromagnetic brake
- Frequent start and stop applications
- Positioning applications
- Half-wave rectifier for standard applications
- Fast acting and multiswitch rectifier for applications in which short opening delay times are necessary

PRODUCT RANGE

Input Voltage V AC	Brake voltage V DC	Starting voltage V DC	Holding voltage V DC	Rectifier type	Application
115	104	104	52	Fast acting rectifier	C L
230	207	207	104	Fast acting rectifier	C L
230	104	207	104	Fast acting rectifier	CS
230	104	190	52	Phase rectifier	CSL
230	104	104	104	Half wave rectifier	C
400	104	180	104	Multiswitch rectifier	C S
460	104	180	104	Multiswitch rectifier	C
460	207	207	207	Half wave rectifier	C

C Continuous running application

S Frequent start/stop application

L Less heat*

* Using a fast acting rectifier or a phase rectifier will save energy and the brake coil heats up less. These types of rectifiers generate a holding voltage lower than the starting voltage of the brake coil itself.

General rules for voltages of rectifiers

One way / Half wave rectifier:

- Output DC voltage = 0.45 x input AC voltage

Fast acting rectifier:

- 1. Bridge rectifier: output DC voltage = 0.9 x input AC voltage for 0.004- 2 s (overexcitation time influenced by external resistance)
- 2. One way rectifier: output DC voltage = 0.45 x input AC voltage

Phase rectifier: - input 230 VAC (only for 104 VDC brakes)

- 1. Overexcitation voltage 190 VDC for 0.15 sec fixed
- 2. Holding brake voltage 52 VDC (50% of the brake voltage is enough to keep the brake open)

ENCODER SKF BEARING

Product description

Characteristics

- Supplies low resolution signals to an external control unit
- Embedded in the rotor bearing
- Cannot be combined with the electromagnetic brake option

Applications

- For applications which require the continuous control of the speed, direction, and position of the drum motor belt or load

TECHNICAL DATA

Rated voltage	From 5 to 24 V
Max.operated current	From 8 to 10 mA
Max.output current	20 mA
High level Voltage	> 3.5 V
Low level voltage	< 0.1 V

INC resolution

The INC resolution (n° of increments per pulley revolution) depends on encoder type and can be calculated as follows:

$$INC = Z \times i$$

i Gear ratio of the drum motor

Z Number of encoder increments per rotor revolution

PRODUCT RANGE

Drum motor	From 5 to 24 V	Increments for rotor revolution
From 80LS to 138LS	6202	32
165LS	6205	48

Note: The drum motor 80LS with encoder has 2 cables-one exiting through each shaft at either end.

Control interface

The encoder has open collector NPN transistor outputs. When connected to the input of a control interface the required load resistances (R) have to be used. The load resistances are stated in the table overleaf. When using different interfaces or, should you have any doubts, please refer to Rulmeca or to a local electronic specialist.

Rulmeca recommends the use of an Opto-coupler for the following reasons:

- To protect the encoder
- To enable connection to other levels such as PNP
- To get the maximum potential between high and low signal

ENCODER SKF

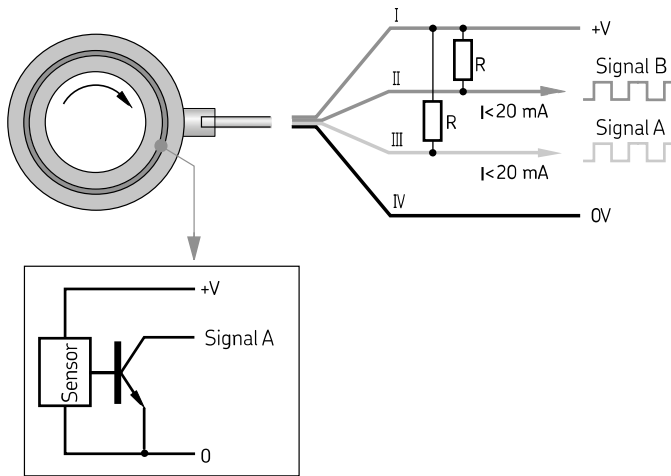

Voltage +V DC	Load Resistances R Ω
5	270
9	470
12	680
24	1500

ENCODER RLS

Product description

Characteristics

- Supplies high resolution signals to an external decoder and control unit
- Embedded in the rotor bearing
- Cannot be combined with an electromagnetic brake

Applications

- For applications which require control of speed, direction, and position of the drum motor belt or load

INC resolution

The INC resolution (n° of increments per pulley revolution) depends on encoder type and can be calculated as follows:

$$INC = Z \times i$$

i Gear ratio of the drum motor

Z Number of encoder increments per rotor revolution

PRODUCT RANGE

Drum motor	Encoder type	Rated voltage V DC	Max. operating current mA	Increments per rotor revolution p	Max.cable length m	Precision °
80LS - 320H	RS422A 5V	5	50	1024	5	0.5

Note: Other resolutions are available on request.

ENCODER RLS

Data sheet
 RM44D01_04
 RM44IC - Incremental, RS422A, 5V
 Alternative for optical encoders

TECHNICAL DATA

Power supply	$V_{dd} = 5\text{ V} \pm 5\%$
Power consumption	35 mA
Output signals	A, B, Z, A-, B-, Z- (RS422A)
Max cable length	5 m
Operating temperature	- 25 °C to +85 °C
Ext. operat. temp.	- 40 °C to +125 °C (IP64)
Edge separation	1 μs minimum

Resolution options (increments per rev)	Maximum speed (rpm)	Accuracy	Hysteresis
1024	20000	$\pm 0.5^\circ$	0.18°
4096	5000	$\pm 0.5^\circ$	0.18°

* Worst case within operational parameters including magnet position and temperature.

CONNECTIONS

Pin Nr.	Function	Wire colour
1	Shield	-
2	Z	White
3	B	Green
4	A	Grey
5	VDD	Red
6	Z-	Brown
7	B-	Yellow
8	A-	Pink
9	GND	Blue

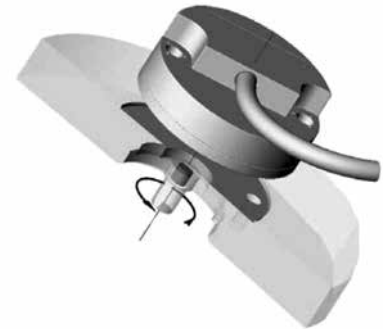

Timing diagram

(complementary signals not shown)

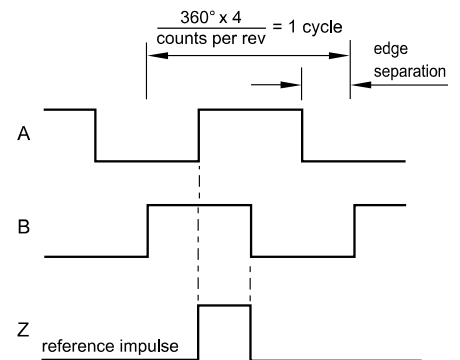

B leads A for clockwise rotation of magnetic actuator.

Recommended signal termination

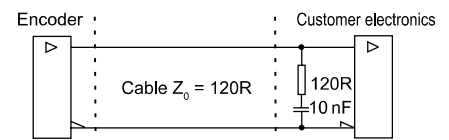

ACCESSORIES



MOUNTING BRACKETS FOR DRUM MOTOR AND IDLER

PRODUCT RANGE

Drum motor	Type	Material	D (mm)	F (mm)	I (mm)	K (mm)	S (mm)	T (mm)	V (mm)	W1 (mm)	X (mm)	X1 (mm)	Z (mm)	Z1 (mm)	Thread	Weight [kg]
80LS	KL 20	Aluminium	20	14	57	38	6.5	9	12	10	72	103	35	55	M6	0.14
113LS	KL 25	Aluminium	25	20	85	55	8.5	11	15	20	110	150	42	66	M6	0.51
138LS	KL 30-A	Aluminium	30	20	89	55	8.5	11	15	20	110	150	44.5	71	M6	0.54
138LS	KL 30-B	Cast iron with black powder coat	30	20	86	57	11	17	12	24	110	180	44.5	72	M8	1.4
165LS-320M	KL 41-HD	Steel with black powder coat	40	30	84	62	14	20	22	40	110	190	50	83	M8	2.1
165LS-320M	KL 41-S/S	Stainless steel	40	30	84	62	14	20	22	40	110	190	50	83	M8	1.9
320H	KL 42	Steel with black powder coat	50	40	121	90	18	30	25	50	150	250	70	110	M8	4.5

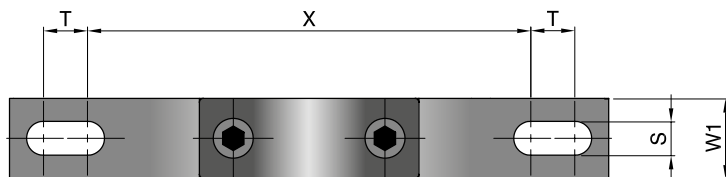
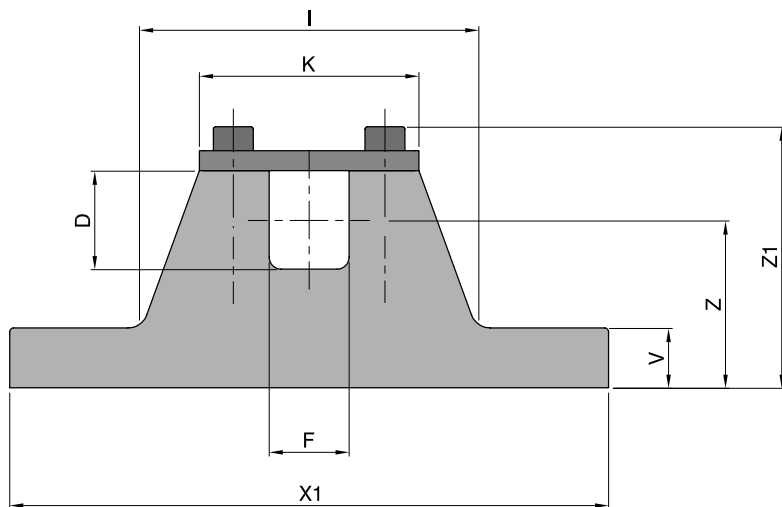

PLANNING SECTION





ENVIRONMENTAL CONDITIONS

Hygienic conditions

For food processing and other applications where hygiene is paramount we recommend the following materials, connectors and accessories:

- Stainless steel Shell,
- Stainless steel Shaft,
- Stainless steel End housing
TS8N/10N version
- IP66 Sealing with NBR or FPM with
stainless steel labyrinth drum motors
- Hot vulcanized Lagging, FDA
approved, white nitrile rubber NBR or in
polyurethane PU
- Oil, food-grade, synthetic
- Stainless steel Terminal box
- Straight or elbow connectors in stainless
steel
- Diamond patterned lagging is not suitable
for food processing as it can be difficult
to clean and leave traces of bacteria

Conveyor frame

According to EHEDG design rules, it is highly recommended to incorporate rust-free open conveyor frames to facilitate easy cleaning, wash down and disinfection of the conveyor, drum motor and belt.

The rubber material shall be USDA/FDA and EC1935/2004 compliant.

Wet and wash down applications

Wet and wash-down subject applications require rust-free or stainless steel materials for the drum motor shell and sealing system.

The following materials and accessories are available:

- Stainless steel or mild steel Shell with hot
vulcanised lagging
- Stainless steel Shaft,
- End housing for saltwater resistant
(80 LS- 138LS) powder coating
(165LS-320H) or with stainless steel shell
(80LS-320M)- TS8N/10N version
- End housings for LP-series, aluminium
with stainless steel cover
- IP66 seal, nitrile rubber NBR or FPM, with
stainless steel labyrinth
- Lagging, all types possible
- Diamond patterned lagging can be used
for non-food wet applications
- Cable connectors, all types possible
- Max. 50 bar at a distance of 0.3 m
- Max. 60°C water temperature for nitrile
rubber NBR regreasable sealing
- Max. 80°C water temperature for nitrile
rubber NBR or FPM sealing

ENVIRONMENTAL CONDITIONS

Dry and dusty applications

All Rulmeca drum motors regardless of specification or material, are sealed to IP66 protection rating. For applications in hazardous areas requiring intrinsically safe or explosion proof motors, please contact Rulmeca.

High temperature

With Rulmeca drum motors, the cooling is due to the contact of the shell with the conveyor belt. It is essential that every drum motor, has an adequate temperature difference between the internal motor and its ambient operating temperature.

All drum motors in the catalogue are designed and tested, without lagging and with a belt for use in a maximum ambient temperature of +40 °C.

- The maximum ambient temperature for standard Rulmeca drum motors is 40° C according to EN 60034
- Every execution is possible, stainless steel versions allow a lower heat dissipation
- Before installing, make sure that the type of oil, declared on the label of the drum motor, ensures a temperature range compatible with the temperature of the applications environment.
- The rubber coating for modular belts can cause overheating of the drum motor, therefore only use recommended specifications
- De-rated motors or standard motors with frequency converters, properly configured for reducing running temperatures (Reduced power and inrush current)
- The rubber lagging to increase the friction with the belts can cause overheating; comply with the limits allowed for the lagging and always connect the motors internal thermal protection.
- For drum motors with motors 6, 8, 12 poles and lagging thicker than 8 mm, use standard motors with frequency converters or de-rated drum motors
- For applications with ambient temperatures above +40 ° C, please contact Rulmeca

ENVIRONMENTAL CONDITIONS

Low temperature

When a drum motor is operated in low temperatures (less than +5 °C), the viscosity of the oil and temperature of the motor when it is not running should be considered. Consider also that condensation inside the drum motor and terminal box may occur with varying wide ranging temperatures.

We recommend the use of the following materials, cables and accessories:

- Mild steel with hot vulcanised lagging or stainless steel Shell
- Stainless steel Shaft,
- End housing in salt water resistant aluminium or solid stainless steel-TS version
- Sealing stainless steel with labyrinth
- Optional special oils for low temperatures
- Use special low temperature seals in temperatures below -25 °C
- System Activation of pre-heating, to prevent condensation
- Lagging, all types possible
- Very low temperatures reduce the effectiveness of the rubber to increase friction
- Cable connections: possible all kinds
- Use of anti rust materials

Anti Condensation heating

In ambient temperatures below +1 °C, consider heating the motor windings to keep the oil viscosity, seals and internal parts at a constant temperature.

If the motor current is switched off for some time and the ambient temperature is very low, then the motor oil becomes viscous. In these situations opt for the use of condensation heating systems, also in order to avoid the formation of ice crystals within the oil seals that would result in a premature damage.

Please refer to Rulmeca.

Altitude higher than 1000 m

The operation of a drum motor at an altitude above 1000 m above sea level may result in a loss of power and overheating due to low atmospheric pressure and the lower density of the air, which cools the motor. The altitude of the final application should be taken into consideration when calculating the required power. For more information please contact Rulmeca.

DIFFERENT POWER SUPPLY

Connecting 3-phase motors to a single phase supply

3-phase motors combined with a frequency converter can be connected to a single phase supply providing that the supply voltage is the same as that of the motor. 3-phase motors generally have a much higher efficiency than single phase motors.

INDUSTRIAL SOLUTIONS

Rulmeca offers a wide range of industrial solutions for different applications and market sectors.

This chapter will only give an overview of some the most important areas covered.

General logistics

Conveying in internal logistics, warehousing and storage handling covers a wide spectrum of applications, such as electronics, chemicals, food, automotive and general manufacturing.

All drum motors in this catalogue are suitable for general logistics applications.

Food application

Rulmeca drum motors are ultra-hygienic and easy to clean. All drum motors for food processing comply with EC 1935-2004 and FDA.

Airport logistics

Airport applications, such as check-in conveyors, X-Ray machines and scanning equipment, require low noise and frequent start / stops. Most applications use friction drive belts made of PU, PVC or rubber.

CERTIFICATIONS



POWER CALCULATION AND SELECTION OF THE DRUM MOTOR FOR UNIT HANDLING

Calculation of the tangential force







- F = Tangential Force [N], $F = F_0 + F_1 + F_2 + F_3$
The tangential forces for drum motors are given in the tables of the range of standard products
- P_n = Belt weight per linear metre
- P_{pr} = Weight of rotating parts of the belt conveyor per metre length (carrying and return section)
- P_{m1} = Weight in Kg of the conveyed product on the load section, or each metre of length of the belt conveyor
- P_{m2} = Weight in Kg of the conveyed product on the return section, for each metre of length of the belt conveyor
- C_1 = Coefficient of friction between product and belt carrying side
- C_2 = Coefficient of friction between belt carrying side and slider bed
- C_3 = Coefficient of friction between return belt and product
- C_4 = Coefficient of friction between return belt side and slider bed
- L = Length of the conveyor in metres
- H = Height difference in conveyor
- F_0-F_3 = Force

Coefficient of friction

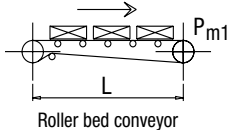
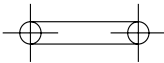
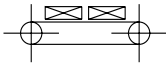
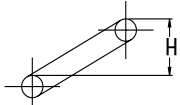
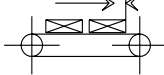
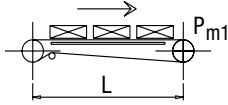
C_2 o C_4	Belt PE	Belt PP	Belt POM
Slide bed	0.30	0.15	0.10
Steel or stainless steel scroll plan slide bed	0.15	0.25	0.20

C_1 o C_3	Belt PE	Belt PP	Belt POM
Steel product	0.15	0.30	0.20
Glass product	0.15	0.15	0.15
Plastic product	0.10	0.15	0.15

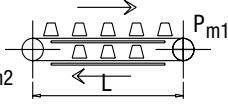
Calculation of the tangential force

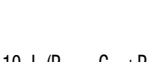
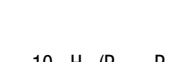
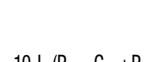
Conveying system	Force without load	Force to convey materials horizontally	Force to convey materials on incline	Accumulation
 <p>Roller bed conveyor</p>	 <p>$F_0 = 0.4 \cdot L \cdot (2P_n + P_{pr})$</p>	 <p>$F_1 = 0.4 \cdot L \cdot P_{m1}$</p>	 <p>$F_2 = 10 \cdot H \cdot P_{m1}$</p>	 <p>$F_3 = 10 \cdot L \cdot P_{m1} \cdot C_1$</p>
 <p>Slide bed conveyor</p>	 <p>$F_0 = 11 \cdot L \cdot P_n \cdot C_2$</p>	 <p>$F_1 = 11 \cdot L \cdot P_{m1} \cdot C_2$</p>	 <p>$F_2 = 10 \cdot H \cdot P_{m1}$</p>	 <p>$F_3 = 10 \cdot L \cdot P_{m1} \cdot C_1$</p>
 <p>Double slide bed conveyor</p>	 <p>$F_0 = 10 \cdot L \cdot P_n \cdot (C_2 + C_4)$</p>	 <p>$F_1 = 10 \cdot L \cdot (P_{m1} \cdot C_2 + P_{m2} \cdot C_4)$</p>	 <p>$F_2 = 10 \cdot H \cdot (P_{m1} - P_{m2})$</p>	 <p>$F_3 = 10 \cdot L \cdot (P_{m1} \cdot C_1 + P_{m2} \cdot C_3)$</p>

REQUIRED DATA FOR POWER CALCULATION

SECTION A - ORDER DETAIL

Drum motor (TM)	Q.ty	Ø [mm]	Type	[kW]	Phase	Voltage [V]	[Hz]	[m/s]	RL [mm]	EL [mm]	AGL [mm]		
Idler Pulley (UT)	Q.ty	Ø [mm]	Type								RL [mm]	EL [mm]	AGL [mm]
TM	UT						New EDP code:					Additional comments:	
Note: please mark the required options with a cross													
		Terminal box stainless steel:				Terminal box aluminium:							
		Elbow connector stainless steel:				Elbow connector polyamide:							
		Straight connector stainless steel:				Straight connector brass:							
		Cable length [m]:				Cable type (screened/halogen free):							
		Insulation class:											
		Special certification:				CSA:	FDA:						
		Backstop:				Motor turning direction (at connection side):							
		Elektromagn. brake:				AC voltage to rectifier [V]:							
		Ø 80 - 220 RLmin + 50 mm				Fail safe unit:		Starts/Stops:					
		Special thermal controller: (PTC):											
		Encoder option:				SKF:	RLS:		Special:				
		VFD-operation:				delivered with VFD:							
		Reversible operation:				Starts/Stops per hour:							
		Stainless steel option:											
		TS8N/TS10N:				TS7N/TS9N (with regreasable labyrinths):							
		Oil:		FDA:		Synthetic:							
		Special environmental condition - kind of aggressivity:											
		Temperature of material to be conveyed if higher than 70°C:											
		Ambient temperature if higher than 40°C or lower than - 25°C:											
		Special mounting vertical:				or with an angle of:		degrees					
		Cylindric shell:				Diameter (if special) [mm]:							
		Additional motor data plate required:											
		Special shell: (customer drawing has to be included)											
		Special shaft design: (customer drawing has to be included)									H [mm]:		
		F (key width) [mm]:				D [mm]:		K or C (flat length) [mm]:					
		Special end housings: (customer drawing has to be included)											
		Low noise requirements [dBA]:				dBA							
		Rubber lagging black/white/blue:				hot/cold vulcan.			Special:				
		Thickness of the lagging [mm]:											
		Special groove measurements: (customer drawing has to be included)											
		Groove type:		Groove dimens. [mm]:		Top:		Bottom:		Depth:			

SECTION B - NECESSARY DETAILS FOR POWER CALCULATION

Type of conveyor:	Slider bed:	Roller bed:	Special:	Inclining/Declining:
Conveyor length [m]:	Load [kg/m]:		Belt width [mm]:	Belt material:
Belt type:	Belt thickness [mm]:		Belt manufacturer:	
Additional comments:				
Environmental conditions:				
Accessories:				

TECHNICAL PRECAUTIONS FOR DESIGN, INSTALLATION AND MAINTENANCE

IMPORTANT INFORMATION

- After unpacking the drum motor, inspect carefully for any damage that may have occurred during transit. Check to be sure all supplied accessories are enclosed with the unit. If you have questions regarding safety or damaged or missing parts, please call one of your nearest RULMECA representative listed at the back of the manual.
- It is the responsibility of the contactor, installer, owner and user to install, maintain and operate the conveyor, components and conveyor assemblies in such a manner as to comply with:
 - The Williams-Steiger Occupational Safety and Health Act and with any and all state and local laws and ordinances as to the national and international standards as to:
 - ANSI – B20.1 Safety Code and Conveyor Equipment Manufacturers Association (CEMA) voluntary consensus standards which may prevail,
 - ANSI – Z535 Warning label Series
 - ISO 3864-2 Product Safety labels.

When existing equipment is being retrofitted, upgraded or even changed, it is in customer's best interest to bring the equipment up to today's standards. If there are any questions, please contact Rulmecca.

CONTENTS

- Transport/Handling
- Drum Motor Mounting Orientation
- Mounting Bracket
- Electrical Installation
- Motor Current Overload and Overcurrent Protection
- Motor Thermal Protection
- Belt Speed
- Belt Pull
- Belt Tension
- Ambient Temperature
- Lagging
- Cycle/Reversible Operation
- Electromagnetic Brake
- Mechanical Backstop
- Food Handling Applications
- Operation without belt/with narrow belt
- Variable Frequency Drive (VFD)
- Altitudes above 1000m
- Single Phase AC Motors
- Oil and Seal Maintenance

TRANSPORT/HANDLING

- For safety reasons during transport and assembly a lifting rope according to the max. weight of the drum motor has to be used. The weight is stamped on the data plate and /or given in the catalogue.
- The rope has to be fixed on the shaft ends.
- Handle with care. DO NOT lift the drum motor at the cable.

DRUM MOTOR MOUNTING ORIENTATION

- Before installing the drum motor, please ensure that the values on the machine plate are corresponding to your requirements.
- At any time, RULMECA drum motors should always be mounted so that the drum shafts are
 1. horizontal,
 2. parallel to idler rollers,
 3. and perpendicular to the conveyor belt centreline.
- Drum motor types 80LS to 220H "UP" is indicated with the word "UP" stamped on the front shaft.

- All drum motors are to be mounted as shown on the sketch below.

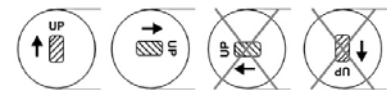

Right! Right! Wrong! Wrong!

- In case of a non-horizontal installation, of more than +/-5 degree, please consult RULMECA.
- At any time all Rulmecca drum motors shown in this catalogue must be fitted with a conveyor belt to prevent overheating.
- Drum motors fitted without a belt must be referred to RULMECA.
- Installation and mounting of the drum motor in another position as described could cause severe product damage and voids product warranty.

MOUNTING BRACKET

- As listed in the catalogue, use the correct RULMECA mounting brackets matching the respective types of drum motors.
- Note that it is physically possible, but not permissible, to interchange mounting brackets between models. Mounting brackets designed for smaller diameters or lower-powered drums may not be used for larger diameters or higher-powered drums.
- Mounting brackets must be mounted to frame in such a way that belt pull is resisted by the shoulder or base of the mounting bracket. Drum motors types 80LS to 220H have a top shaft retaining plate. This plate is not designed to resist belt pull.
- The designer must select appropriate mounting bolts to resist belt forces and/or the weight of the drum depending on the mounting position of the drum.
- All types of mounting brackets must be fully supported by and fastened to the conveyor frame in such a way that the shafts ends do not deform. Shaft ends must always be fully supported by the brackets.

- Mounting brackets should be fitted in such a way that they are in contact with the shoulder of each shaft. This will:
 1. Eliminate drum motor axial play between mounting brackets.
 2. Keep shaft deflection to a minimum.
- In noise-sensitive areas, the designer should use heavier gauge support structure and appropriate vibration isolating material, as necessary.
- When Rulmeca drum motor mounting brackets are NOT used, it is essential that:
 1. The mounting equipment supports at least 80% of the shaft flats.
 2. It has to be assembled without any clearance between the support and the shoulder of the shaft.
 3. The clearance between the shaft flats and the support should be less than 0.4mm (torsion play).
- A drum motor with frequent reversible operations or many start/stops should be mounted with No axial clearance between the shaft flat and the brackets
- Not following these precautions could cause drum and/or mounting bracket damage and voids product warranty.

ELECTRICAL INSTALLATION

- Always use licensed electrician to install the unit. All electrical installation and wiring must be conform to the national code of the National Electrical Standards. Turn the electrical power off at the electrical panel board (circuit breaker or fuse box) and lock or tag the panel board door to prevent someone from turning on power while you are working on the unit, failure to do so could result in serious electrical shock, burns or possible death. According to the European Council Directives related to machinery, the equipment manufacturer (OEM) has to secure that the drum motor is NOT put into operation before it is
 - o Correctly installed,
 - o Correctly connected to the power supply,
 - o Correctly protected against rotating parts,

- A specialist must perform the electrical connection of the drum motor in accordance with electrical regulations. If in doubt, contact Rulmeca.
- A wiring diagram is always supplied with the drum motor. Always refer to the connection instructions and ensure that the motor power and control circuits are properly connected.
- The wiring diagram is inserted in the accompanying booklet and into the terminal box.
- As standard, Rulmeca drum motors are delivered with clockwise rotation when viewed from the terminal box end of the drum motor. Always refer to the connection instructions and ensure that the motor is connected as required to the correct mains supply.
- As a safety measure, please use the earth screw located in the terminal box.
- The protective conductor has to be connected to the earth screw.
- When using cable options the green/ yellow wire has to be connected to the protective conductor of the main supply.

All safety devices, including wiring of electrical safety devices itself will not result in a hazardous condition.

MOTOR CURRENT OVERLOAD AND OVER CURRENT PROTECTION

- Motor control systems must include protection against operating drum motors in excess of Full Load Amperage (FLA.). The control system should also include protection against voltage spikes and excessive jogging of motors. Failing to provide adequate current overload and over current protection could stress the motor and voids product warranty.
- FLA data is available for all motors upon request. FLA data is also supplied on motor label for each drum motor.
- Electrical power, control, and protection for drum motors must adhere to all pertinent regulations.

MOTOR THERMAL PROTECTION

- All drum motor motors are supplied with a built-in thermal protector in each phase. Protection consists of heat-sensitive, bi-metallic switches built into each motor phase winding. The switches are designed to open if motor temperature elevates to an inappropriately high level. 2.5 Amps are the permissible current of standard versions. The voltage is 230V.
- These switches must be connected to a normally closed control circuit (in series with a magnetic coil/relay device and contactor) in order to validate product warranty.
- A motor control circuit should kill motor power if thermal switch opens. Thermal switches will automatically close as motor cools. Cooling times vary with drum model, power, and size. However, 30 to 60 minutes is common with most motors in an ambient temperature of 20°C.

BELT SPEED

- The belt speed shown in this catalogue is defined as the actual speed at full load measured at the standard outer diameter of the drum motors with a tolerance of +/- 10%.
- For single phase drum motors the tolerance range could be between +10% and -20%.
- Nominal speed is a design objective, providing consistent choice among all types.
- Actual belt speed is almost never exactly equal to nominal belt speed.
- The actual speed at full load is typically 5% lower than no load speed because of the rotor slip of an asynchronous motor.
- The slip rate is dependent on power and design of the motor. Low-powered motors have a lower slip rate than high-powered motors.
- With rubber lagging or bigger diameters the belt speed is increasing according to the formula below. Please recalculate the belt speed in one of the mentioned cases.

Example: A 0.75kW drum motors 138LS with an un-lagged drum diameter of 138mm has a nominal speed of 0.8m/sec.

TECHNICAL PRECAUTIONS FOR DESIGN, INSTALLATION AND MAINTENANCE

The actual belt speed is a function of

- The rotor speed (RPM),
- Gear ratio,
- Shell diameter,
- Load.

E. g. the above mentioned 138LS with a nominal belt speed of 0.8m/sec. has

1. A gear ratio of $i = 25.2$,
2. A rotor speed of $n = 2845$ (1/min),
3. A shell diameter of 0.138m,

The actual speed at full load is

$$v \text{ (m/sec)} = \pi \times d \text{ (m)} \times \text{rpm (1/min)} / 60 \times i$$

$$\pi = \text{Pie (3.14),}$$

$$d = \text{drum diameter (m),}$$

$$\text{rpm} = \text{revolutions of the rotor per minute,}$$

$$i = \text{gear ratio}$$

$$v = 3.14 \times 0.138\text{m} \times 2845\text{min}^{-1} / (60 \times 25.2) = 0.815\text{m/sec.}$$

If this drum is supplied with 10mm thick lagging, the belt speed of the lagged drum equals 0.815m/sec. $\times (0.158\text{m}/0.138\text{m}) = 0.93\text{m/sec.}$ at full load, nominal voltage and 50Hz.

- For actual speeds at full load please refer to the power range charts in this catalogue
- To control an exact speed a Variable Frequency Drive can be used.

BELT PULL

- The catalogue specifies belt pull for each model, power and speed. Note that the specified actual belt pull comprises motor and gear box losses. I.e. the belt pull shown in the catalogue is the „utilisable belt pull“.
- Rulmecca recommends to select the drum motors power by comparing calculated “required belt pull (F)” with “Actual Belt Pull” and not simply on the basis of calculated Power (kW).
- Belt pull “F” is a summary of all of the existing forces to convey the material. E.g.
 1. F1 – force to move the belt,
 2. F2 – force to accelerate the material,
 3. F3 – force to lift or lower the conveyed material,
 4. F4 – force to clean the belt,

5. F5 – force to overcome roller resistance or slider bed resistance,

6. F6 – force to frictional resistance of ploughs, etc.

- Furthermore, with special application additional power requirements can be needed (e.g. for belt operating under a hopper, squeezing of belt, accumulation, belt guiding, extreme stiff belts etc.).

BELT TENSION

- The conveyor belt shall be installed with sufficient belt tension to prevent belt slippage. Therefore the required tension at bottom side (T2 see picture) can be calculated after DIN 22101 or CEMA Standard. The belt must never be over-tensioned.
- Actual belt tension can be roughly defined after belt manufacturer’s specifications by measuring the belt elongation.
- The maximum allowable belt tension T1+T2 of each drum motors is specified in the power range charts of this catalogue. It can be reduced at higher speeds.
- **The belt type, belt thickness and the correct drum motors diameter have to be according to the belt manufacturer’s specifications.** Too small drum motors diameters could lead to a damage of the belt.
- Over tension of the belt may damage internal components of the drum motors and is shortening the product lifetime.
- There is no product warranty in case of damages due to over tension of the belt.

AMBIENT TEMPERATURE

- Drum motors are normally cooled by dissipating heat through contact between the surface of the drum and the conveyor belt. It is essential that each drum have an adequate thermal gradient between the drum’s motor stator and its ambient operating temperature.
- All drum motors in this catalogue are designed and tested under full load without rubber lagging and with a belt for

a use in a max. ambient temperature of +40°C.

- The drum motor specifications “maximum allowable temperature” refers to the temperature of the air or the bottom of the conveyor belt in contact with the drum motor.
- For ambient operating conditions lower or higher than allowable ambient temperature (-25°C to 40°C) contact RULMECA.
- In many cases it is possible to use specially designed drum motors to perform tasks for special applications – e.g. modular plastic belts and V-belts. Please contact RULMECA for such applications.
- Operating Rulmecca drum motors to drive standard conveyor belts outside of the allowable ambient temperature range voids product warranty.

LAGGING

- Smooth, diamond pattern and profiled lagging is available in different colours. Approximate rubber hardness is 65-70 durometer (shore hardness A).
 - Cold bonded or hot vulcanised lagging is available for high power/high torque/high temperature applications and for drum motors with Class H motors.
 - Oil & grease resistant synthetic rubber is also available for oily operating conditions and/or for certain types of belt material. Check with belting supplier if belt/lagging material compatibility could be a problem.
 - Adequate drum motor heat dissipation is necessary.
 - Lagging thickness and width greatly affect drum heat dissipation characteristics!
 - Contact RULMECA before applying any lagging to drum surface to obtain thickness and width specifications and maintain drum motor warranty coverage.
 - Lagging material is a wear item and should be replaced when it wears out. Service life depends upon the application. Product warranty does not include lagging wear.
- Rubber lagging affects the heat dissipation characteristics of drum motors.

Please contact Rulmeca, when you are uncertain about the use of rubber lagged drum motors.

CYCLE / REVERSIBLE OPERATION

•Rulmeca drum motors are designed to operate either continuously in the LS drum motor range or intermittently in the LP & LS drum motor range.

3-phase types	Max. no. of Start/Stops per minute
80LP,113LP	15
80LS,113LS	15
138LS,	4
165LS, 216LS,	3
220M/H	2

1-phase types	Max. no. of Start/Stops per minute
80LP,113LP	10
138LS-216LS	Please contact Rulmeca.

- For reversible operation the Drum motors should be installed in the centre of the conveyor. Therefore it is necessary to install additional idlers.
- Some drum motors can be specially prepared for reversible operation. Please specify reversible operation on the order.

ELECTROMAGNETIC BRAKE

- The spring-loaded electromagnetic brake is intended for use as a conveyor belt holding brake and a positioning brake.
- The control circuit for the drum motor and brake must be designed to stop the drum motor before brake clamps are shut and start the drum motor after the brake is released.
- Spring-loaded electromagnetic brakes are designed to release when power is applied to the brake coil. This is a "fail safe" feature. The clamp shuts when brake power is removed (either during normal operation or during an emergency loss of overall system power).
- Control circuits must be designed so that motor and brake never work against each other. The brake should never be

clamped shut when the motor is on except for "emergency stop" condition. The motor should never be powered on (including "jog" command) when the brake is clamped shut.

- Electromagnetic brakes are DC-powered. They are supplied with AC to DC rectifiers to be mounted in a remote panel (by others). Rectifiers must be fuse-protected.
- Motor control circuits must be designed to kill motor power in the event of loss of brake power. If this safety provision is not made, it is possible for a drum motor to be "powered through" a clamped brake, burning brake and/or motor.
- A wiring diagram is supplied with every drum motor. Always ensure that motor and brake power and control circuits are connected according to instructions.
- For rectifier connection and protection instructions, refer to rectifier data sheet supplied with the drum motor.
- Neglecting these instructions could cause damage to the motor and/or brake and voids product warranty.
- The built in brake disc is a wear part and has a limited lifetime depending on the operation conditions. In case of premature wear off the operation conditions have to be checked and evaluated. Product warranty does not include wear parts of the brake.

MECHANICAL BACKSTOP

- Drum motors fitted with mechanical backstops must be used on inclined conveyors to prevent run back of the loaded belt which may result in minor or moderate injury when power supply is off.
- The backstop is built into the drum motor and is mounted on the rotor shaft.
- If the drum motor is supplied with optional mechanical backstop the sense of rotation is indicated by an aluminium arrow or plastic sticker fastened to the end housing on the terminal box (or power cord) side of the drum. Clockwise or counter-clockwise backstops are available.
- Rotation direction needs to be specified when placing order.
- The sense of rotation is specified from the point of view of a person looking at

the drum from the terminal box (or power cord) side of the drum.

- It is essential that the identity of each of the three phases of the power supply be determined before attaching power supply wires to the drum to prevent the motor from driving against the backstop. The identity of each of the three phases of the motor is clearly labelled on the terminal board, terminal strip, or wires (in power cord type).
- Driving the motor against the mechanical backstop may damage motor and/or backstop and voids product warranty.

FOOD HANDLING APPLICATIONS

- The use of Rulmeca drum motors in food handling applications requires a totally stainless steel (TS8N) configuration of the outer material like shell, shafts and end housings.
- Rulmeca offers a variety of food approved (FDA) oil, rubber laggings and profiled rubber laggings for modular belting.

OPERATION WITHOUT BELT / WITH NARROW BELT

- A drum motor usually needs the belt for heat dissipation. To operate a drum motor without belt or with belts covering less than 2/3 of the roller length please refer to Rulmeca.
- Some lower powered and derated drum motors are usable as standard in continuous operation without belt. The selection of a suitable drum motor is always depending on the actual operation conditions. Rulmeca will assist you with the application design.
- If you are using standard drum motors in non-belt applications without confirmation from Rulmeca voids the product warranty.

VARIABLE FREQUENCY DRIVE (VFD)

- Do not run the Drum motors out of the frequency range or in another uncommon way. This could lead to overheating or

TECHNICAL PRECAUTIONS FOR DESIGN, INSTALLATION AND MAINTENANCE

overloading of internal components and voids product warranty.

- It is essential that the VFD be set within the motors allowable operating spectrum. For Rulmeca Drum motors the allowable frequency spectrum is 15Hz to 65Hz. There will not more than 5% torque loss within this range.
- VFDs are designed for a certain maximum length and cross section of the motor cable. This is specified by the VFD manufacturer and should be in general up to 10m. The heat development in the VFD increases with the length of the motor cable. The capacity reactance and herewith the losses in the cable are increasing and causing dangerous resonant frequencies. If the output current of the VFD is not reduced it will switch off the drum motor. Bigger cable cross sections or shorter cables may avoid this effect.
- To protect the motor from dangerous resonant frequencies with high voltage peaks it is recommended using a motor filter at the output of the VFD. This is available from the VFD manufacturer.
- To avoid electromagnetically influences to other electrical devices Rulmeca recommends to use always screened cables in connection with VFD operation.
- The cable screen has to be connected with a grounded part according to the electrical engineering rules.

ALTITUDES ABOVE 1000M

- Operation at altitudes above 1000 m is causing a height depending power loss of the motor. This has to be considered at the power calculation. If you need assistance please refer to Rulmeca.

SINGLE PHASE AC-MOTORS

- The use of different capacitors than the stated on the type label has influence to motor run, temperature performance and noise and leads in case of damages to deletion of the product warranty.

OIL AND OIL SEAL MAINTENANCE

- Oil type and contents are given on the motor nameplate.
- Standard, synthetic, food grade, low viscosity (for low temperature applications,) and high viscosity (for noise-sensitive areas) are all available. For approved oil types and quantities, see the oil type and content chart in this catalogue.
- Rulmeca recommends periodic oil changes and are supplied with two oil fill/drain plugs in end housing.
- The first oil change for all non-synthetic oils should be changed after 20.000 operational hours. This is due to normal wear of gears.
- Synthetic oils may be changed after each 50,000 operating hours.
- Magnetic oil plug(s) should be cleaned during each oil change. A red dot plastic sticker indicates the position of the magnetic oil plug.
- Only approved non-conductive oil may be used in drum motors.
- Note that oil seals, regardless of oil type used, should be changed after 30,000 operating hours. Drum motor standard types 80LS to 220H require a disassembly to change oil seals. RULMECA service personal or authorized local service providers to perform this work.

Take special precautions when changing brands of oil and types of oil because of potential oil incompatibility. Contact your local oil supplier for assistance.

- For example, when changing from standard to synthetic oil, it is necessary to:
 1. Completely drain old standard oil;
 2. Partially fill drum with "Clean-Flush-Lubricate" (CFL) fluid;
 3. Run drum for 20 minutes;
 4. Drain CFL fluid completely; then
 5. Fill drum with appropriate amount of new synthetic oil.
- Failing to observe these oil and oil seal precautions could shorten drum service life and voids product warranty.



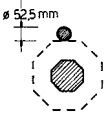
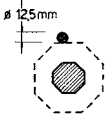
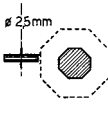
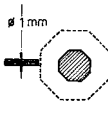
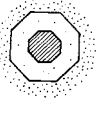
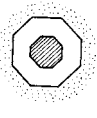

- All the above instructions refer to drum motors **CONSTANTLY** working under **FULL LOAD**. In case of drum motors **NOT** working continuously under full load, the service life will increase considerably! When checking the oil, the cleanness of the oil is always the best guideline of
 - The wear and present position of the gears and bearings
 - Whether to change the oil immediately
 - Whether it is possible to delay the oil change.

INTERNATIONAL PROTECTION IP RATINGS

Protection against solid bodies

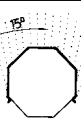
IP	Symbol	Test Definition
0		Not Protected
1		Protected against touch with the flat of the hand and large solid objects greater than 50mm
2		Protected against finger-touch and solid objects greater than 12mm.
3		Protected against solid objects greater than 2.5mm
4		Protected against solid objects greater than 1.0mm.
5		Dust-protected! Dust shall not penetrate in a quantity to interfere with the satisfactory operation of the apparatus.
6		Dust-tight

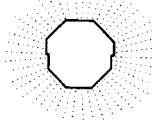
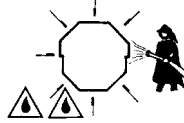
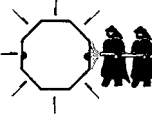
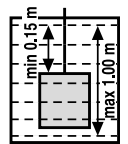
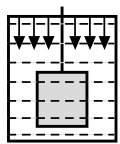
Protection of internal equipment against harmful ingress of water

IP	Symbol	Test Definition
0		Not Protected
1		Protected against dripping water.
2		Protected against dripping water when tilted up to 15°.
3		Protected against spraying water.
4		Protected against splashing water.
5		Protected against water jets (P1 nozzle 6.3mm, water delivery rate 12.5 l/min ± 5%)
6		Protected from projections of water similar to marine swells (P2 nozzle 12.5mm, water delivery rate 100 l/min ± 5%)
7		Ingress of water in quantities causing harmful effects shall not be possible when the enclosure is temporarily (30 min.) immersed 1 meter in water under standardized conditions of pressure and time
8		Ingress of water in quantities causing harmful effects shall not be possible when the enclosure is continuously immersed in water under conditions, which shall be agreed between manufacturer and the user, but are more severe than for no. 7
9		IP69 - Protected from water during high pressure/steam cleaning (not submersible)

OIL TYPES AND CONTENTS

Roller type	IEC34 Insulation Class	Ambient Temp.	ISO 3498 DIN51519	DIN 51517	Castrol	BP	ESSO Mobil	Shell	Texaco	Fuchs
80LS Standard mineral	F	-5°C +40°C	CC ISOVG 68	CLP ISOVG 68	ALPHA SP 68	ENERGOL GR-XP 68	MOBILGEAR 600 XP 68	OMALA 68	MEROPA 68	
80LS Synthetic option	F & H	-25°C +40°C	CC ISOVG 68	CLP ISOVG 68	ALPHA SYN T 68		SHC 626 68			
80LS Synthetic food grade	F & H	-40°C +40°C	CC ISOVG 68	CLP ISOVG 68						CASSIDA FLUID HFS 68
113LS Standard mineral	F	-5°C +40°C	CC ISOVG 150	CLP ISOVG 150	ALPHA SP 150	ENERGOL GR-XP 150	MOBILGEAR 600 XP 150	OMALA 150	MEROPA 150	
113LS Synthetic option	F & H	-25°C +40°C	CC ISOVG 150	CLP ISOVG 150	ALPHA SYN T 150		SHC 629 150			
113LS Synthetic food grade	F & H	-30°C +40°C	CC ISOVG 150	CLP ISOVG 150						CASSIDA GL150
138LS - 220H Standard mineral	F	-5°C +40°C	CC ISOVG 150	CLP ISOVG 150	ALPHA SP 150	ENERGOL GR-XP 150	MOBILGEAR 600 XP 150	OMALA 150	MEROPA 150	
138LS - 220H Synthetic option	F & H	-25°C +40°C	CC ISOVG 220	CLP ISOVG 220	ALPHA SYN T 220		SHC 630 220			
138LS - 220H Synthetic food grade	F & H	-30°C +40°C	CC ISOVG 220	CLP ISOVG 220						CASSIDA GL220

Note: Drum motors of the LP range contain lifetime oil filling.

Oil contents in litres for vertical mounting regardless of drum width		
	Litres	Special construction
Ø 80	0.2	} Electrical connection to be located at the top
Ø 113	0.6	
Ø 138	1,4	
Ø 165	3.0	
Ø 220	10	

Note: The given oil contents are valid for standard unlagged drum motors only.
For special options the oil quantity can deviate.
Therefore always use the given oil quantity shown on the data plate.

OIL TYPES AND CONTENTS IN LITERS

Drum motors in horizontal applications

RL	80LS	113LS	138LS	165LS	216LS	220M 0.37-0.55 kW 1.1-1.5 kW	220H 0.75 kW 2.2-5.5 kW
200	0.10						
250	0.14	0.32					
300	0.18	0.43	0.7				
350	0.22	0.54	0.9	1.2	3.0		
400	0.26	0.65	1.1	1.4	3.4	3.0	
450	0.30	0.76	1.3	1.6	3.9	3.5	4.0
500	0.34	0.87	1.5	1.8	4.3	4.0	5.0
550	0.38	0.98	1.8	2.0	4.8	4.3	5.3
600	0.42	1.09	2.0	2.3	5.2	4.5	5.5
650	0.46	1.20	2.2	2.5	5.6	4.8	5.8
700	0.50	1.31	2.4	2.7	6.1	5.0	6.0
750	0.54	1.42	2.6	2.9	6.5	5.3	6.3
800	0.58	1.53	2.8	3.1	7.0	5.5	6.5
850	0.62	1.64	3.0	3.3	7.4	5.8	6.8
900	0.66	1.75	3.2	3.5	7.8	6.0	7.0
950	0.70	1.86	3.4	3.7	8.3	6.3	7.3
1000	0.74	1.97	3.7	3.9	8.7	6.5	7.5
1050		2.08	3.8	4.1	9.2	6.8	7.8
1100		2.19	4.0	4.4	9.6	7.0	8.0
1150		2.30	4.2	4.6	10.0	7.3	8.3
1200		2.41	4.4	4.8	10.5	7.5	8.5
1250			4.6	5.0	10.9	7.8	8.8
1300			4.8	5.2	11.4	8.0	9.0
1350			5.0	5.4	11.8	8.3	9.3
1400			5.1	5.6	12.2	8.5	9.5
1450			5.3	5.8	12.7	8.8	9.8
1500			4.8	6.0	13.1	9.0	10.0
1550			5.0	5.8	13.6	9.3	10.3
1600			5.1	6.0	14.0	9.5	10.5
1650			5.3	6.2	14.4	10.0	11.0
1700			5.5	6.4	14.9	11.5	11.5
1750			5.6	6.6	15.3	12.0	12.0
1800			5.8	6.8	15.8	13.0	13.0
1850			5.9	7.0	16.2	13.5	13.5
1900				7.1	16.6	14.0	14.0
1950				7.3	17.1	15.5	14.5
2000				7.5	17.5	15.0	15.0

Note: The given oil contents are valid for STANDARD drum motors only. For special options the oil contents might deviate slightly. Therefore, always use the given oil quantity stated on the data plate.

CABLES

The overview shows the available cables for elbow or straight exits.
For an operation via frequency inverter Rulmeca recommends the usage of screened cables.

Drum motor series	80LS / 113LS	80LS / 113LS	80LS / 113LS	80LS / 113LS	80LS / 113LS	113LS / 138LS	113LS / 138LS	113LS / 138LS	113LS / 138LS	113LS / 138LS / 165LS <=1.5kW
Quantity main core	7	7	7	7	4	9	7	7	9	9
Cross section [mm]	0.50	0.50	0.50	0.50	0.75	0.75	0.75	0.75	0.75	0.75
Numeric or colour code	Numeric	Numeric	Numeric	Numeric	Numeric	Numeric	Numeric	Numeric	Numeric	Numeric
Insulation conductors main core	PVC	special-mixture HFFR	PVC	TPE	TPE	special-mixture HFFR	special-mixture HFFR	PVC	PVC	PVC
Halogen-free	X	✓	X	X	X	✓	✓	X	X	X
Quantity data core	-	-	-	2	2	-	-	-	-	-
Cross section [mm]	-	-	-	0.34	0.34	-	-	-	-	-
Numeric or colour code	-	-	-	colour code	colour code	-	-	-	-	-
Insulation outer sheath	PVC	special-mixture HFFR	PVC	PVC	PVC	special-mixture HFFR	special-mixture HFFR	PVC	PVC	PVC
Halogen-free	X	✓	X	X	X	✓	✓	X	X	X
Colour outer sheath	grey RAL7001	grey RAL7001	grey RAL7001	orange RAL 2003	orange RAL 2004	grey RAL7001	grey RAL7001	grey RAL7001	grey RAL7001	orange RAL 2003
Screen material	-	-	copper	copper	copper	-	copper	copper	-	copper
Outer diameter [mm]	6.7	6.9	7.5	7.9	7.5	9.6	8.5	10.5	10.5	10.5
Operating voltage [V]	300/500	300/500	300/500	300/500	300/500	300/500	300/500	300/500	300/500	300/500
Operating voltage [V] acc. UL		600		600	600	600		600	600	600
Temperature range	-15°C -70°C	-30°C -70°C	-5°C -70°C	-5°C-70°C UL -5°C -90°C	-5°C-70°C UL -5°C -90°C	-30°C -70°C	-25°C -70°C	-5°C-70°C UL -5°C -90°C	-5°C-70°C UL -5°C -90°C	-5°C-70°C UL -5°C -90°C
Approval				CSA/UL	CSA/UL			CSA/UL	CSA/UL	UL

80LP-113LP CONNECTION DIAGRAMS

Connection diagrams for drum motor cable connection 80LP - 113LP

Colors or lead numbers for standard turning direction clockwise.
(lead numbers for screened cable)

TP - Thermal protector T1 & T2

Color code

- gn - green
- ye - yellow
- bu - blue
- bn - brown
- vt - violette
- bk - black
- wh - white
- rd - red
- gy - grey

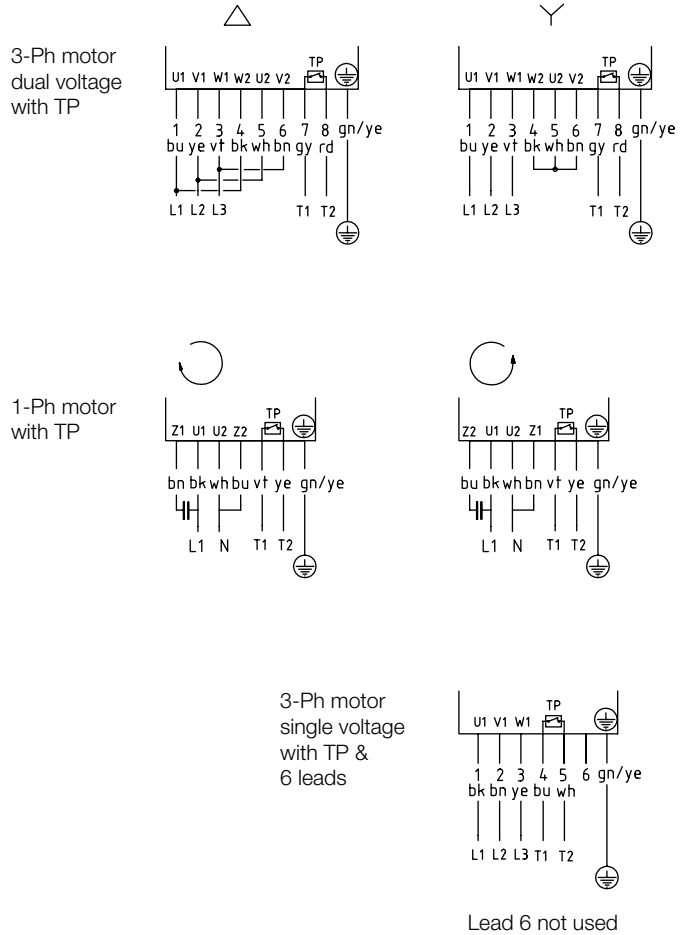

80LS-165LS CONNECTION DIAGRAMS

Connection diagrams for drum motor cable connection 80LS - 165LS ELB - only single voltage

Lead numbers for standard turning direction clockwise.

TP - Thermal protector T1 & T2

ELB - Electromagnetic brake B1 & B2

Color code

- gn - green
- ye - yellow
- bu - blue
- bn - brown

3-Ph motor dual voltage with TP

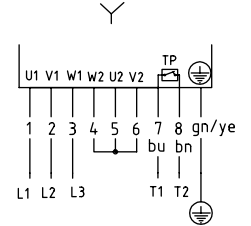
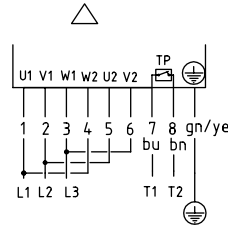

1-Ph motor with TP & ELB optional for 138LS & 165LS only

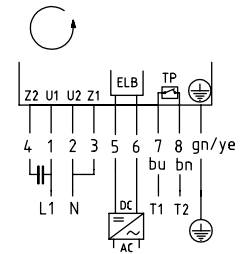
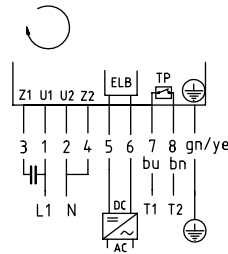

3-Ph motor single voltage with TP & 9 leads

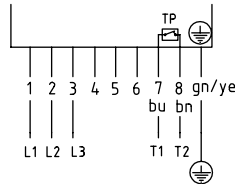

Lead 4,5,6 not used

3-Ph motor single voltage with TP & 7 leads

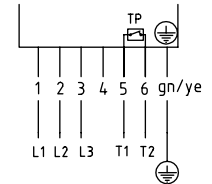

Lead 4 not used

3-Ph motor single voltage with TP & ELB

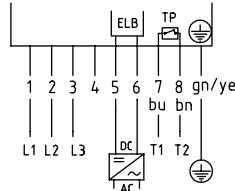

Lead 4 not used

3-Ph motor single voltage with TP & ELB

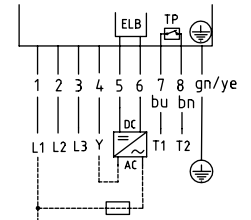

Use lead 4 for internal ELB only!

113LS CONNECTION DIAGRAMS

Connection diagrams for drum motor Terminal box with WAGO clamp 113LS (ELB only single voltage)

Characters in brackets for 2 stage gearbox
turning direction clockwise.

TP - Thermal protector T1 & T2

ELB - Electromagnetic brake B1 & B2

Color code

- RD - Red
- BN - Brown
- BK - Black
- GY - Grey
- BU - Blue
- VT - Violet
- WH - White

Assembly instruction

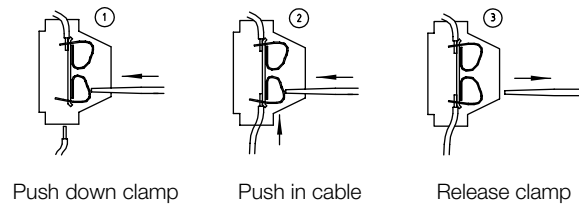

3-Ph motor
dual voltage
with TP

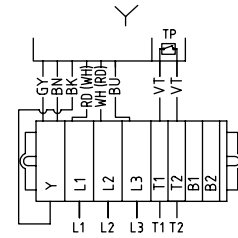
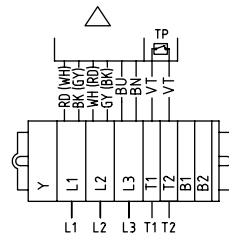

3-Ph motor
single voltage
with TP

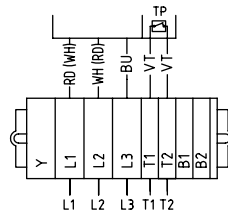

3-Ph motor
single voltage
with TP & ELB

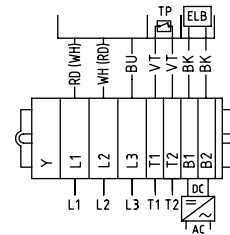

138LS - 220H CONNECTION DIAGRAMS

Connection diagrams for drum motor Terminal box with WAGO clamp 138LS - 220H (138LS - ELB only single voltage)

Characters in brackets for 2 stage gearbox
turning direction clockwise.

TP - Thermal protector T1 & T2

ELB - Electromagnetic brake B1 & B2

Color code

- RD - Red
- YE - Yellow
- BK - Black
- GY - Grey
- BU - Blue
- GN - Green
- WH - White
- BN - Brown

Assembly instruction

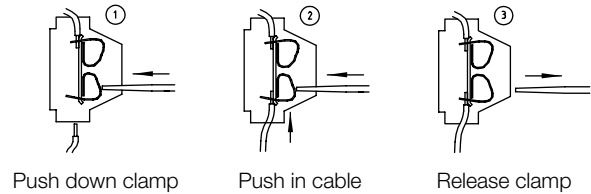

3-Ph motor
dual voltage
with TP

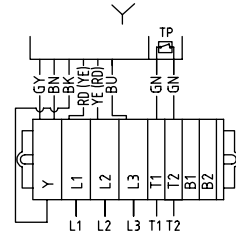
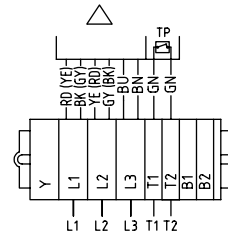

3-Ph motor
dual voltage
with TP & ELB

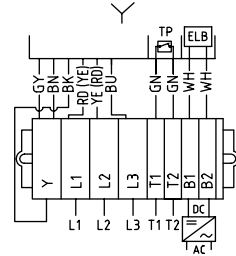
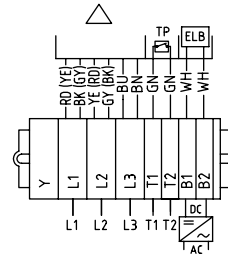

3-Ph motor
single voltage
with TP

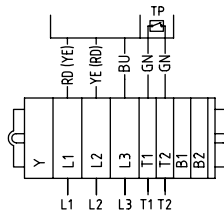

3-Ph motor
single voltage
with TP & ELB

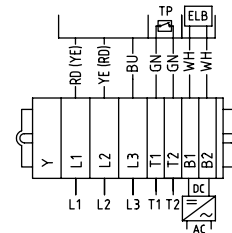

1-Ph motor
with TP

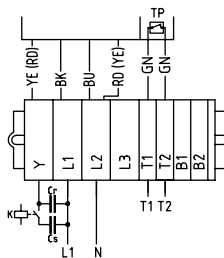

1-Ph motor
with TP & ELB

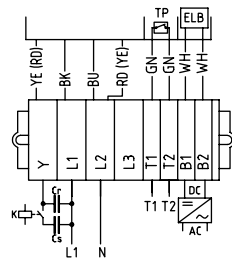

Cr - Run capacitor
Cs - Start capacitor

Cr - Run capacitor
Cs - Start capacitor

220M - 220H CONNECTION DIAGRAMS

Connection diagrams for drum motor Cable connection 220M - 220H

Lead numbers for turning direction
clockwise.

TP - Thermal protector T1 & T2

ELB - Electromagnetic brake

Color code

GN - Green

YE - Yellow

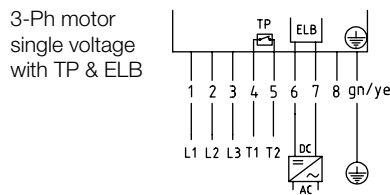
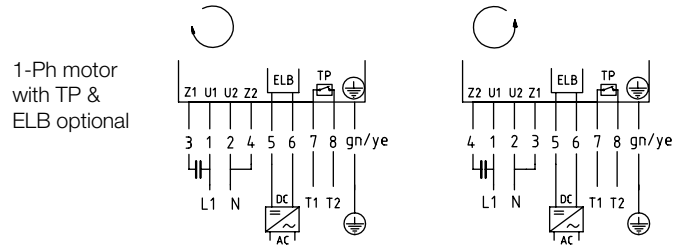
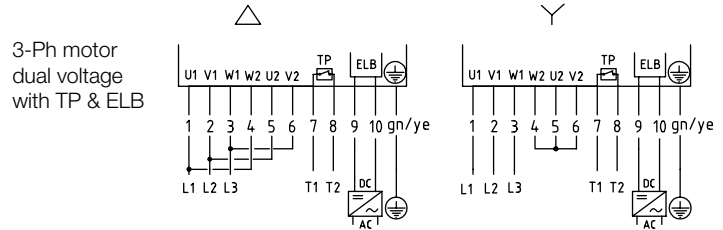
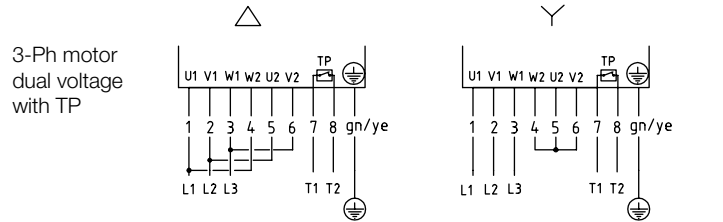

Lead 8 not used

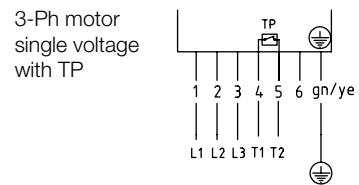

Lead 6 not used

EXTERNAL CONNECTION DIAGRAMS FOR DRUM MOTORS 5.5 KW

Terminal Box 5.5 kW

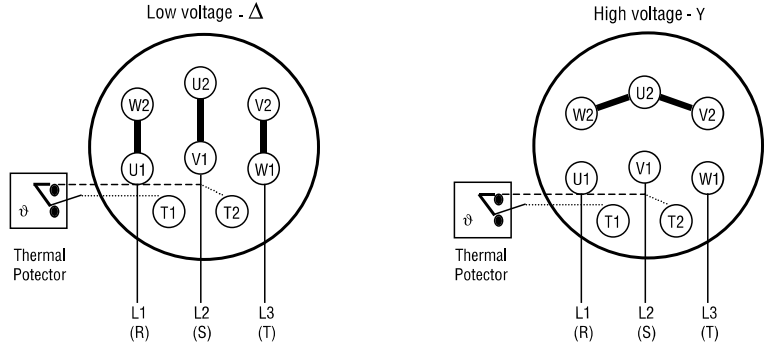

Electromagnetic Brake Configuration

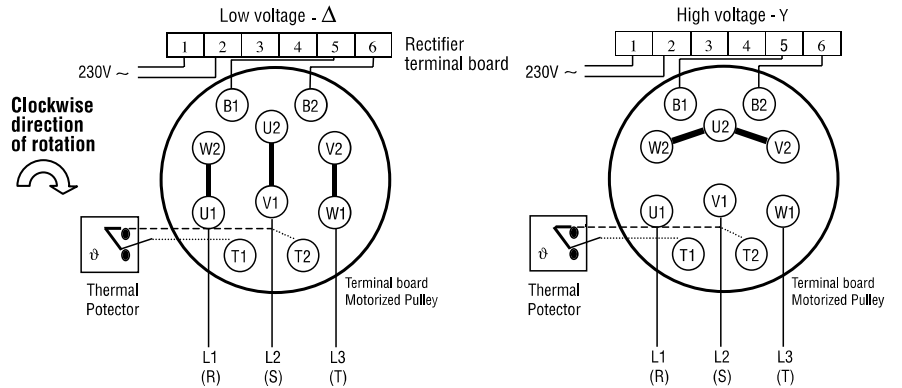

3-phase single voltage 5.5 kW

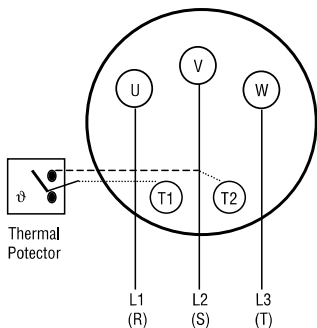

USA - Configuration

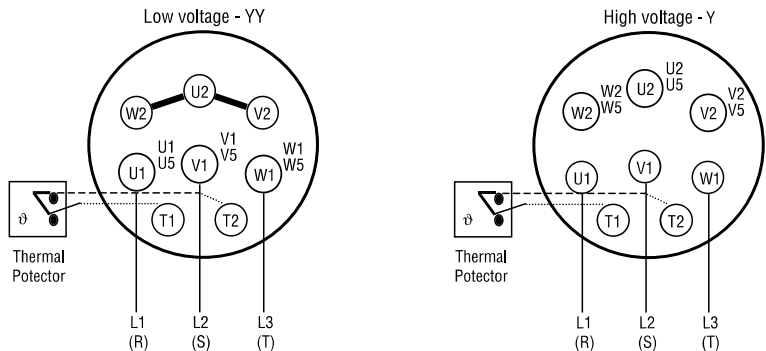



LIGHT INDUSTRIAL
DRUM MOTOR RANGE

INDUSTRIAL
DRUM MOTOR RANGE

OPTIONS

ACCESSORIES

PLANNING SECTION

THE RULMECCA PRODUCT RANGE

The Rulmecca product range for the Unit Handling sector comes complete with:



Rollers and Components for Unit Handling and Industrial Applications Catalogue



Solutions for Dynamic Warehouses Catalogue

LIGHT INDUSTRIAL
DRUM MOTOR RANGE

INDUSTRIAL
DRUM MOTOR RANGE

OPTIONS

ACCESSORIES

PLANNING SECTION



EUROPE

Belgium
UVO Technologies bvba
Rozenlei 37
2540 Hove
Phone: +32 34 55 43 22
Mobile: +32 479 820 684
Fax: +32 34 54 36 70
www.uvotec.eu
info@uvotec.eu

Denmark / Sweden
Rulmeca A/S
Byleddet 7 DK- 4000
Roskilde - Danmark
Phone 1: +45 3677 6755
Fax: +45 3677 6855
dk@rulmeca.com

Finland / Estonia / Lithuania / Latvia
Rulmeca Oy
Ridalintie 3
03100 Nummela Finland
Phone 1: +358 922435510
Mobile: +358 50 5667 455
www.rulmeca.fi
fi@rulmeca.com

France
RULMECA France S.A.S.
Z.A. des Marlières
Rue des Marlières
C.S. 10033
59710 AVELIN (France)
Phone: + 33 (0)3.20.00.41.30
Fax: +33 (0)3.20.00.41.31
info.france@rulmeca.com

Germany
RULMECA GERMANY GmbH
Wilslebener Chaussee 12 - 14,
06449 Aschersleben
Tel.: +49 (0) 3473 956-222
Fax: +49 (0) 3473 956-333
de@rulmeca.com

Italy
RULLI RULMECA S.P.A.
Via A. Toscanini, 1
I-24011 Almè Bergamo
Phone 1: +39 035 4300 111
Fax: +39 035 545523
rulmeca@rulmeca.com
export-it@rulmeca.com

Poland
RULMECA POLAND Sp. z o.o.
ul. Zielona 12,
58-200 Dzierżonów
tel.: +48 74 832 08 22
fax: +48 74 832 08 21
pl@rulmeca.com
www.rulmeca-poland.com

Spain
RULMECA IBÉRICA, S.L.U.
Pol. Ind. Can Roqueta II -
c/ Can Manent, 31
08202 Sabadell
Phone: +34 93 544 9199
Fax: +34 93 574 4424
espana@rulmeca.com

Turkey
**RULMECA TASIMA AKSAMLARI
TICARET LIMITED SIRKETI**
Dekocity AVM
Erler Mah. Dumlupınar Bulvarı No:348/61
06930 Ümitköy/ANKARA
Phone 1: +90 312 284 64 74
Mobile: +90 541 284 64 01
Fax: +90 312 284 64 78
turkey@rulmeca.com

United Kingdom
RULMECA UK Ltd
Brunel Road
Earlstrees Industrial Estate
Corby, Northants
NN17 4JW GB
Phone 1: +44 1536 748525
Fax: +44 1536 748535
uk@rulmeca.com

NORTH & SOUTH AMERICA

Canada
RULMECA CANADA LIMITED
75 Mason Street, Wallaceburg,
Ontario, Canada, N8A 4L7
Phone 1: +1 (519) 627-2277
Fax: +1 (519) 627-5115
Toll Free Phone From Canada
and U.S.A. 1-800-661-4065
sales@rulmeca.ca
www.rulmeca.ca

United States
RULMECA Corporation
6508 Windmill Way,
Suite B Wilmington, NC, USA
28405
Phone 1: +1 910-794-9294
Fax: +1 910-794-9296
mgawinski@rulmeca.com
www.rulmecacorp.com

Venezuela
INDUSTRIAS RULMECA S.A.
Zona Industrial Municipal Norte
Calle Este Oeste Galpón 67-200
Valencia, Edo. Carabobo, Venezuela
Phone 1: +58-241-833.62.49
Fax: +58-241-832.15.17
www.rulmeca.com.ve
rulmeca@cantv.net

ASIA

China
RULMECA (TIANJIN) CO., LTD.
D1-2 & D1-4, Saida International
Industrial Park, Xiqing Economic
Development Area (XEDA)
300385 Tianjin
Phone 1: +86-22-2388-8628
Fax: +86-22-2388-9828
http://www.rulmeca.com.cn
sales-cn@rulmeca.com

Indonesia
PT. RULMECA INDONESIA
Rukan Mutiara Taman Palembang B5 No.15
Cengkareng
Jakarta Barat 11730
Phone 1: +62 21 5435 5608
Mobile: +62 812 814 6188
Fax: +62 21 5435 5608
sales-id@rulmeca.com

Thailand
RULMECA (THAILAND) CO. LTD.
55/12 Moo 15, Tambol Bangsaothong,
Amphur Bangsaothong
10540 Samutprakarn
Phone 1: +66 2 1825280-85
Fax: +66 2 1825286-87
sales-th@rulmeca.com

AUSTRALIA

RULMECA MELCO AUSTRALIA (PTY) LTD
Building 6 Garden City Office Park
2404 Logan Rd
Eight Mile Plains Queensland 4113
Phone 1: +61 (0) 467666067
www.melcoconveyors.com
mrobinson@rulmeca.com

SOUTH AFRICA

MELCO Conveyor Equipment
Cnr. Hertzog & Jack Pienaar Street
Germiston South Ext. 7, P.O. Box 131,
1400 Germiston
Phone 1: +27 87 806 3160
Fax: +27 11 825 3592
www.melcoconveyors.com

Moving ahead.

Rulmeca Holding S.p.A
Via A. Toscanini 1
I-24011 Almè (BG) Italy
Tel. +39 035 4300111
Fax +39 035 545523

Please contact your local
Rulmeca Company, our
contact details you will
find in our web site:
www.rulmeca.com

