



# VIBRATION DAMPERS

## Highly elastic and tearproof mounts for passive and active vibration dampening

- Vibration-free mounting of motor test stands, emergency generators, compressors, etc.
- Tearproof mounting of suspended loads such as crane tracks and cable car cabins
- Anti-vibration machine leveling feet with balancing ball joints
- Impact-resistant vibration dampers for energy dissipation at belt transfer stations
- Standardised product range for high load capacities

### Product advantages:

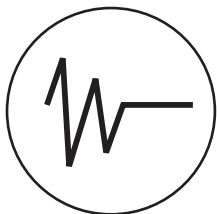

high degree  
of isolation

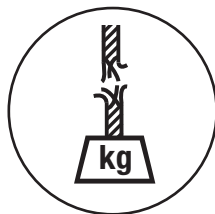



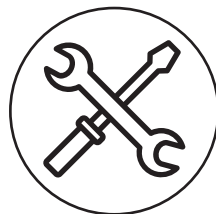



tearproof



maintenance-free

# Selection table vibration dampers

	Illustration	Type	Description	Page
Vibration dampers basic types		<b>ESL</b>	Vibration dampers for the absorption of tensile, pressure and shear load. Also ideal for wall and ceiling installations. 8 element sizes from 200 N to 19 000 N. Natural frequency between 3.5–8 Hz. Mounts are mainly used for overcritical machine installations (machine frequency > mount frequency).	4.3
		<b>AWI</b>	Vibration dampers for to absorb tensile and pressure loads. 7 element sizes from 180 N to 16 000 N. Natural frequency between 3–7 Hz. Mounts are mainly used for overcritical machine installations (machine frequency > mount frequency).	4.4
		<b>V</b>	Vibration dampers for the absorption of tensile, pressure and shear load. Also ideal for wall and ceiling installations. 6 element sizes from 300 N to 12 000 N. Natural frequency between 10–30 Hz. Mounts can be used for subcritical machine installations (machine frequency < mount frequency).	4.5
Vibration dampers additional types		<b>N</b>	Mounting feet consisting of insulating plate, top cover with built-in levelling jack-screw with spherical joint for compensation of up to 5° of floor unevenness. Insulating plate oil- and acid-proof. 3 element sizes from 1 500 N to 20 000 N. Natural frequency between 19–25 Hz.	4.6
		<b>NOX</b>	Mounting Feet consisting of insulating plate, stainless steel top cover with built-in stainless levelling jackscrew with spherical joint to compensate of up to 5° of floor unevenness. Insulating plate oil- and acid-proof. 2 element sizes from 5 000 N to 20 000 N. Natural frequency between 19–22 Hz.	
		<b>Base plate P</b>	Accessories for N and NOX for high shear forces or for assembling on a base or frame. The base plate must be bolted to the floor.	4.7
		<b>NE</b>	Adhesive cushioning plates made of closed-cell polyether urethane, no water absorption and good oil resistance. 3 element sizes from 500 N to 130 000 N. Natural frequency between 14–25 Hz.	4.8

# Vibration damper

## ESL

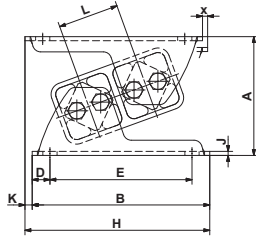

sizes 15 to 45

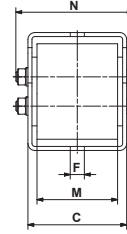

from size 50

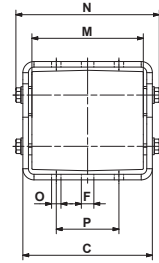

Part no.	Type	Load $G_{min.} - G_{max.}$ [N] on Z-axis	A unloaded	A* max. load	B	C	D	E	$\varnothing F$
05 021 001	<b>ESL 15</b>	200–550	54	43	85	49	10	65	7
05 021 002	<b>ESL 18</b>	450–1 250	65	51	105	60	12.5	80	9.5
05 021 003	<b>ESL 27</b>	700–2 000	88	68	140	71	15	110	11.5
05 021 004	<b>ESL 38</b>	1 300–3 800	117	91	175	98	17.5	140	14
05 021 005	<b>ESL 45</b>	2 200–6 000	143	110	220	120	25	170	18
05 021 016	<b>ESL 50</b>	4 000–11 000	170	138	235	142	25	185	18
05 021 017	<b>ESL 50-1.6</b>	5 500–15 000	170	138	235	186	25	185	18
05 021 018	<b>ESL 50-2</b>	7 000–19 000	170	138	235	226	25	185	18

Part no.	Type	H	J	K	L	M	N	O	P	x max.	Weight [kg]	Natural frequency $G_{min.} - G_{max.}$ [Hz]	Material structure
05 021 001	<b>ESL 15</b>	91	2	5.5	25.5	40	58.5	–	–	1.5	0.3	8.2–5.8	Aluminium profile, steel plate, nodular cast sizes 50 to 50-2), painted blue, zinc-plated couplings
05 021 002	<b>ESL 18</b>	111	2.5	5.5	31	50	69	–	–	1.9	0.6	7.5–5.0	
05 021 003	<b>ESL 27</b>	148	3	8	44	60	85.3	–	–	2.7	1.3	6.2–4.5	
05 021 004	<b>ESL 38</b>	182	4	7	60	80	117	–	–	3.6	3.1	5.5–4.0	
05 021 005	<b>ESL 45</b>	235	5	15	73	100	138	–	–	4.4	5.9	5.0–3.5	
05 021 016	<b>ESL 50</b>	244	6	9	78	120	162	13.5	90	10	10.7	5.0–3.5	
05 021 017	<b>ESL 50-1.6</b>	244	8	9	78	160	206	13.5	90	10	14.7	5.0–3.5	
05 021 018	<b>ESL 50-2</b>	244	8	9	78	200	246	13.5	90	10	18.0	5.0–3.5	

\* compression load  $G_{max.}$  and cold flow compensation (after approx. 1 year).

If no other units are specified, the numbers given are in mm.

The sizes 50 to 50-2 can be combined with one another (identical heights and operation behaviour).

The max. load on X-axis should not exceed 200 % of the Z-axis capacity.

The max. load on Y-axis should not exceed 20 % of the Z-axis capacity.

Applicable on tensile, pressure and shear load.



# Vibration damper

## AWI



AWI R

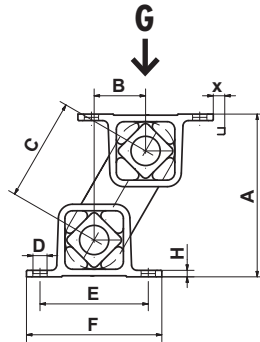

sizes 15 to 27

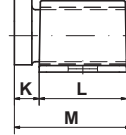

sizes 38 to 50

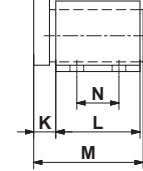

size 50-2

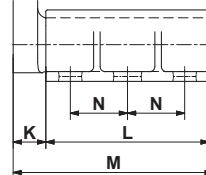

AWI L

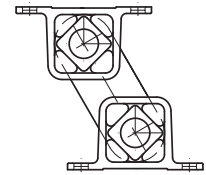

Part no.	Type	Load $G_{min.} - G_{max.}$ [N]	A unloaded	A* max. load	B	C	D	E	F
05 111 101	AWI 15R	180–400	68	55	22.5	45	7×10	50	65
05 121 101	AWI 15L	180–400	68	55	22.5	45	7×10	50	65
05 111 102	AWI 18R	350–850	88	70	30	60	9×15	60	80
05 121 102	AWI 18L	350–850	88	70	30	60	9×15	60	80
05 111 103	AWI 27R	650–1500	111	91	35	70	11×20	80	105
05 121 103	AWI 27L	650–1500	111	91	35	70	11×20	80	105
05 111 104	AWI 38R	1200–3000	150	122	47.5	95	13×20	100	125
05 121 104	AWI 38L	1200–3000	150	122	47.5	95	13×20	100	125
05 111 105	AWI 45R	2000–4800	177	145	55	110	13×26	115	145
05 121 105	AWI 45L	2000–4800	177	145	55	110	13×26	115	145
05 111 106	AWI 50R	4000–9600	194	159	60	120	17×27	130	170
05 121 106	AWI 50L	4000–9600	194	159	60	120	17×27	130	170
05 111 108	AWI 50-2R	6600–16000	194	159	60	120	17×27	130	170
05 121 108	AWI 50-2L	6600–16000	194	159	60	120	17×27	130	170

Part no.	Type	H	K	L	M	N	x max.	Weight [kg]	Natural frequency $G_{min.} - G_{max.}$ [Hz]	Material structure
05 111 101	AWI 15R	3	10	40	52	–	14	0.5	7.2–4.5	Stainless steel casting GX5CrNi19-10 (1.4308)
05 121 101	AWI 15L	3	10	40	52	–	14	0.5	7.2–4.5	
05 111 102	AWI 18R	3.5	14	50	67	–	19	0.9	6.5–3.7	
05 121 102	AWI 18L	3.5	14	50	67	–	19	0.9	6.5–3.7	
05 111 103	AWI 27R	4.5	17	60	80	–	22	1.9	6.0–3.7	
05 121 103	AWI 27L	4.5	17	60	80	–	22	1.9	6.0–3.7	
05 111 104	AWI 38R	6	21	80	104	40	31	4.5	5.2–3.2	
05 121 104	AWI 38L	6	21	80	104	40	31	4.5	5.2–3.2	
05 111 105	AWI 45R	8	28	100	132	58	35	7.8	5.0–2.8	
05 121 105	AWI 45L	8	28	100	132	58	35	7.8	5.0–2.8	
05 111 106	AWI 50R	12	40	120	165	60	38	12.8	4.8–2.8	
05 121 106	AWI 50L	12	40	120	165	60	38	12.8	4.8–2.8	
05 111 108	AWI 50-2R	12	45	200	250	70	38	20.3	4.8–2.8	
05 121 108	AWI 50-2L	12	45	200	250	70	38	20.3	4.8–2.8	

\* compression load  $G_{max.}$  and cold flow compensation (after approx. 1 year).

If no other units are specified, the numbers given are in mm.

The sizes 50 and 50-2 can be combined with one another (identical heights and operation behaviour).

# Vibration damper

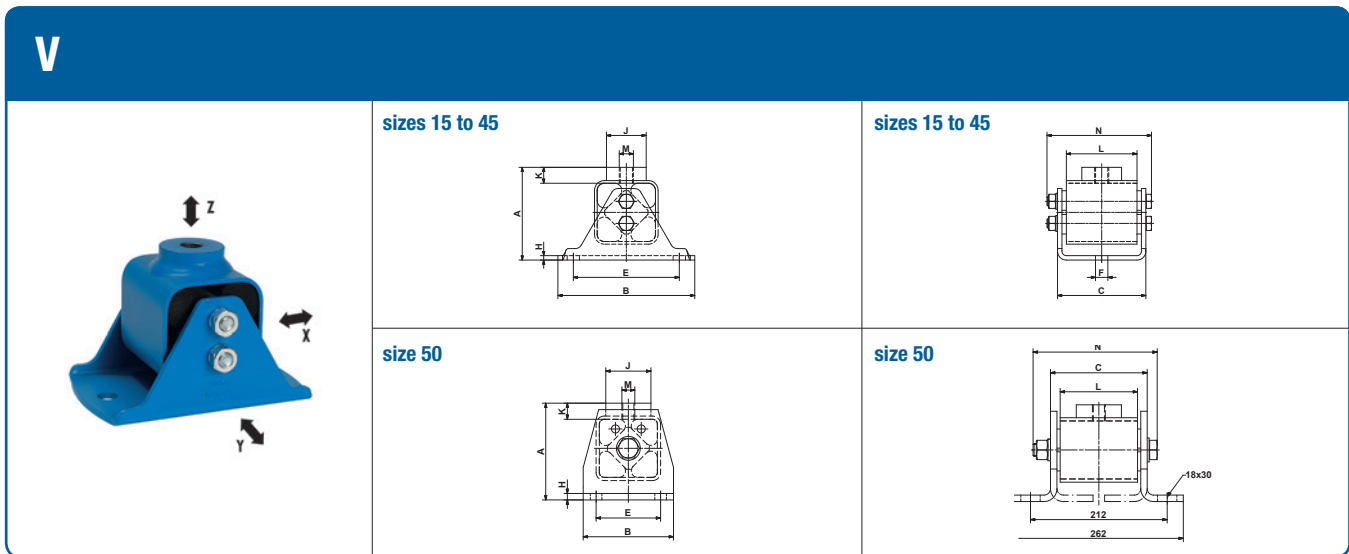

Part no.	Type	Load $G_{min.} - G_{max.}$ on X- and Z-axis	A	B	C	E	$\varnothing F$	H	$\varnothing J$
05 011 001	<b>V 15</b>	300–800	49	80	51	55	9.5	3	20
05 011 002	<b>V 18</b>	600–1 600	66	100	62	75	9.5	3.5	30
05 011 003	<b>V 27</b>	1 300–3 000	84	130	73	100	11.5	4	40
05 011 024	<b>V 38</b>	2 600–5 000	105	155	100	120	14	5	45
05 011 005	<b>V 45</b>	4 500–8 000	127	190	122	140	18	6	60
05 011 006	<b>V 50</b>	6 000–12 000	150	140	150	100	–	10	70

Part no.	Type	K	L	M	N	Weight [kg]	Natural frequency $G_{min.} - G_{max.}$ [Hz]	Material structure
05 011 001	<b>V 15</b>	10	40	M10	59	0.3	30–23	Aluminium profile, welded steel housings, painted blue, zinc-plated couplings
05 011 002	<b>V 18</b>	13	50	M10	74	0.6	25–15	
05 011 003	<b>V 27</b>	14.5	60	M12	85	1.2	28–20	
05 011 024	<b>V 38</b>	17.5	80	M16	117	2.5	14–12	
05 011 005	<b>V 45</b>	22.5	100	M20	143	4.5	15–12	
05 011 006	<b>V 50</b>	25	120	M20	193	7.5	12–10	

If no other units are specified, the numbers given are in mm.  
 The max. load on Y-axis should not exceed 20 % of the X- resp. Z-axis capacity.  
 Momentary shock loads of 2.5 g in X- and Z-axis admissible.  
 Applicable on tensile, pressure and shear load.  
 V 50: Alternativ mounting position 180° turned.

# Vibration damper

## N / NOX

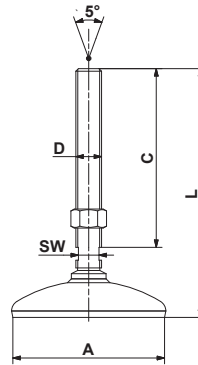

Part no.	Type	Load $G_{min.} - G_{max.}$ [N]	Natural frequency $G_{min.} - G_{max.}$ [Hz]	$\phi A$	C	D	L	SW	Weight [kg]	Material structure (rubber pad NBR with 50 ShA)
05 058 001	<b>N 80 M12</b>	1 500–6 000	25–22	80	55	M12	100	10	0.3	galvanised, base painted blue
05 058 002	<b>N 80 M16</b>	5 000–12 000	22–19	80	136	M16	182	13	0.5	galvanised, base painted blue
05 058 102	<b>NOX 80 M16</b>	5 000–12 000	22–19	80	136	M16	182	13	0.5	stainless steel 1.4301 and 1.4305
05 058 004	<b>N 120 M20</b>	10 000–20 000	22–19	120	139	M20	195	16	1.0	galvanised, base painted blue
05 058 103	<b>NOX 120 M20</b>	10 000–20 000	22–19	120	139	M20	195	16	0.9	stainless steel 1.4301 and 1.4305

If no other units are specified, the numbers given are in mm.

# Vibration damper

P

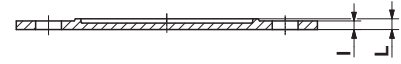
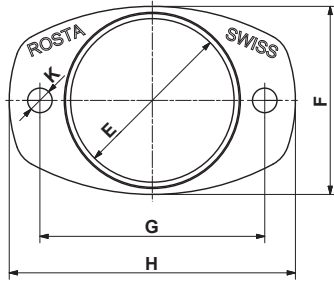

Part no.	Type	Accessory to	$\varnothing E$	F	G	H	I	$\varnothing K$	L	Weight [kg]	Material structure
05 060 101	<b>P 80</b>	N/NOX 80	80	92	110	140	4	12	5	0.1	Aluminium cast
05 060 102	<b>P 120</b>	N/NOX 120	120	135	170	210	5	16	7	0.3	

If no other units are specified, the numbers given are in mm.



# Vibration damper

NE

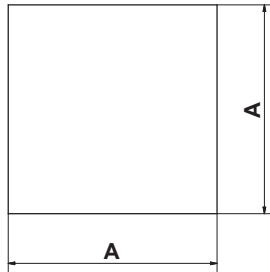

Part no.	Type	Load $G_{min.} - G_{max.}$ [N]	Deflection $G_{min.} - G_{max.}$ [mm]	Natural frequency $G_{min.} - G_{max.}$ [Hz]	A	B	Weight [kg]	Material structure
05 100 901	NE 50-12	500–1500	0.5–1.4	25–14	50	12.5	0.02	– Polyether-Urethane closed-cell – No water absorption – Working temperature –30 to +70 °C – Good oil-resistance
05 100 902	NE 80-12	1500–4500	0.5–1.4	25–14	80	12.5	0.06	
05 100 903	NE 400-12	44000–130000	0.5–1.4	25–14	400	12.5	1.54	

If no other units are specified, the numbers given are in mm.

Tolerances according to ISO3302-1:1999 class L3 and EC3. The deflection of the cushions by the mentioned max. catalogue load capacities is 1.4 mm.