



for a greener tomorrow



**MITSUBISHI
ELECTRIC**

Changes for the Better

FACTORY AUTOMATION

Mitsubishi Electric AC Servo System MELSERVO-J5

e-Factory

Digest Edition

Innovate
Together



MITSUBISHI ELECTRIC SERVO SYSTEM

MELSERVO-J5



Create new value with MELSERVO-J5. Unlock performance with a total drive solution.

Maximize system performance

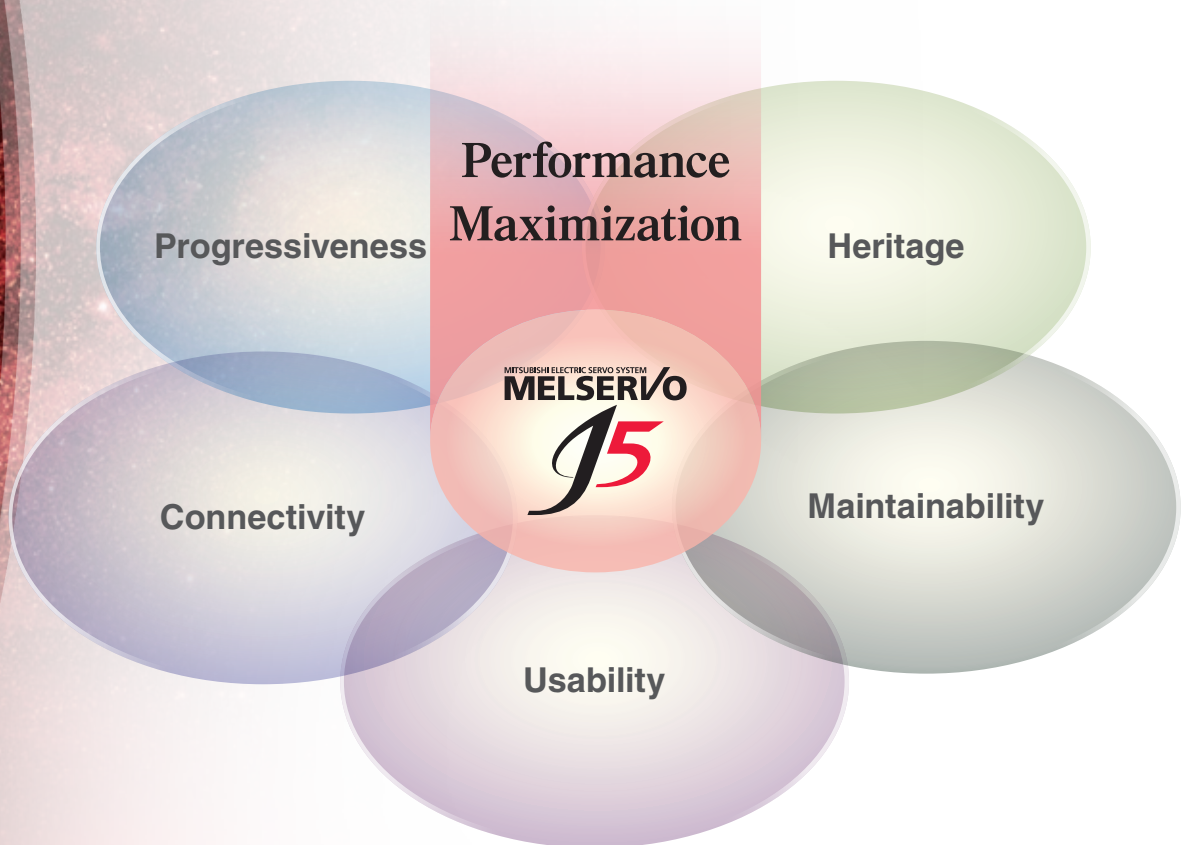

Progressiveness



For evolution of machines

- Performance improvement
- Program standardization

Connectivity



For flexible system configurations

- Integration with connectable devices

Usability



For quick operation start

- Tool enhancement
- Improved drive system usability

Maintainability



For prompt detection and diagnosis of failures

- Predictive/preventative maintenance
- Corrective maintenance

Heritage



For utilization of existing devices

- Interchangeability with previous generation models

Concept

Created using a brand new approach, this next-generation servo system contributes to reducing the TCO through improved productivity

Focused on improving total performance.

The MELSERVO-J5 series servo system boasts industry-leading level basic performance.

The high-speed, high-precision capabilities of MELSERVO-J5 help to increase the productivity of your machines.



Motion module
RD78GH **NEW**

Motion module
RD78G

Minimum operation cycle *1
31.25
µs

Max. number of control axes *1
256
axes



*1. The values are applicable when RD78GH is used.



Motion Control Software
SWM78 **Available soon**

Minimum operation cycle *2
250
µs

Max. number of control axes
256
axes

*2. The number of controllable axes varies by the operation cycle.

CC-Link IE TSN

CC-Link IE TSN supports TCP/IP communications and applies it to industrial architectures through its support of TSN enabling real-time communications. With its flexible system architecture and extensive setup and troubleshooting features make CC-Link IE TSN ideal for building an IIoT infrastructure across the manufacturing enterprise.

The communications speed is 1 Gbps.

* TSN: Time Sensitive Networking
* IIoT: Industrial Internet of Things

CC-Link IE TSN

Servo System Controllers

The servo system controller performs various types of motion control, including positioning, synchronous, cam, speed, and torque control. We offer two new types of servo system controllers: RD78GH/RD78G Motion modules and SWM78 Motion Control Software.

Motion Modules

RD78GH/RD78G Motion modules utilize a multi-core processor to achieve enhanced basic performance.

Motion Control Software

SWM78 Motion Control Software performs motion control by being installed on an industrial personal computer with a real-time operating system.

MITSUBISHI ELECTRIC SERVO SYSTEM
MELSERVO-J5

CC-Link IE TSN
MELSERVO-J5 series
servo amplifiers

5 kW, 7 kW added

Speed frequency response	Command communication cycle ^{*3}
3.5 kHz	31.25 μs

*3. MR-J5-G/MR-J5-G-RJ support 31.25 μs.



MR-J5-G

MR-J5W2-G

MR-J5W3-G

MR-J5-G-RJ



HK series rotary servo motors

5 kW, 7 kW added

NEW

Max. speed ^{*4}	Encoder	Encoder resolution	Functional safety ^{*5}
6700 r/min	Batteryless absolute position encoder	26 bit	Functional safety encoder

*4. The servo motor speed varies by the models.

*5. Supported by HK-KT_WS/HK-ST_WS.

Simple converters



Capacity ^{*6}	Connectable servo amplifiers
3 kW	6 units (max.)

*6. Power supply input: 200 V

Servo Amplifiers

The MELSERVO-J5 series high-performance, industry-leading servo amplifiers feature a unique control engine that is more powerful than ever before. These servo amplifiers can connect to CC-Link IE TSN to perform high-speed, high-precision control. Each multi-axis servo amplifier drives a maximum of either two or three servo motors (depending on the model of servo amplifier chosen), simplifying wiring and enabling a compact machine at a lower cost. 5 kW and 7 kW of MR-J5-G/MR-J5-A servo amplifiers are newly released.

A Wide Range of Safety Sub-Functions Enhanced functions

MR-J5-G-RJ supports a wide range of safety sub-functions and safety communication via CC-Link IE TSN. The safety level is improved when the servo amplifiers are combined with HK-KT_WS/HK-ST_WS servo motors with functional safety. The servo amplifiers support the safety sub-functions of STO/SS1/SS2/SOS/SBC/SLS/SSM/SDI/SLI/SLT at a safety level of SIL 2 or SIL 3.

Rotary Servo Motors

The HK series rotary servo motors are equipped with a 26-bit resolution batteryless absolute position encoder. HK-KT_WS/HK-ST_WS servo motors with functional safety are newly released.

Batteryless Absolute Position Encoders

Mitsubishi Electric's unique multi-revolution detection method allows the saving of absolute position data without a battery.

Single Connector/One-Touch Lock/Single Cable Type

The servo motor power supply, encoder, and electromagnetic brake can be connected using only a single cable. The one-touch lock lever allows for simple wiring.

* "Industry-leading level" refers to results from a Mitsubishi Electric July 2020 research study.

Unlock new system capabilities together with CC-Link IE TSN

CC-Link IE TSN

Motion Module

RD78GH NEW

RD78G



These Motion modules with multiple-core processors enable to configure a high-speed, large system by supporting the CC-Link IE TSN real-time open network.

- Performs positioning control such as linear interpolation using function blocks. The programming is easy: users just need to set positioning data to the function blocks.
- Connects to various modules such as servo amplifiers and I/O modules via CC-Link IE TSN. This connectivity allows you to configure a servo system more flexibly.
- Supports a consistent engineering environment that is capable of handling tasks ranging from system design to debugging and maintenance.

Product Lines

RD78GH

RD78G



CC-Link IE TSN
MELSEC iQ-R
series

RD78GHV NEW
RD78GHW NEW

- Maximum number of control axes:
128 axes/module (RD78GHV)
256 axes/module (RD78GHW)
- Minimum operation cycle *1: 31.25 μ s
- ST language program capacity:
Built-in ROM max. 64 MB
+ SD memory card

RD78GHV/RD78GHW are designed with a quad-core processor that enables higher-speed control. These Motion modules can be directly programmed to distribute load control with PLC CPUs.

This ensures that performance will not be degraded even when the number of axes is increased.



CC-Link IE TSN
MELSEC iQ-R
series

RD78G4/RD78G8
RD78G16/RD78G32
RD78G64

- Maximum number of control axes:
64 axes/module (RD78G64)
- Minimum operation cycle *1:
62.5 μ s Upgraded
- ST language program capacity:
Built-in ROM max. 16 MB + SD memory card

RD78G4/RD78G8/RD78G16/RD78G32/RD78G64 are designed with a dual-core processor, and can be programmed to enable various types of control, such as positioning, synchronous, cam, speed, and torque control.

*1. The operation cycle varies by the number of control axes and the models.

System Configuration

The Motion Module provides functionality equivalent to a CC-Link IE TSN master/local module *1 and executes motion control while functioning as a master station. This dual functionality results in reduced system costs without sacrificing performance.

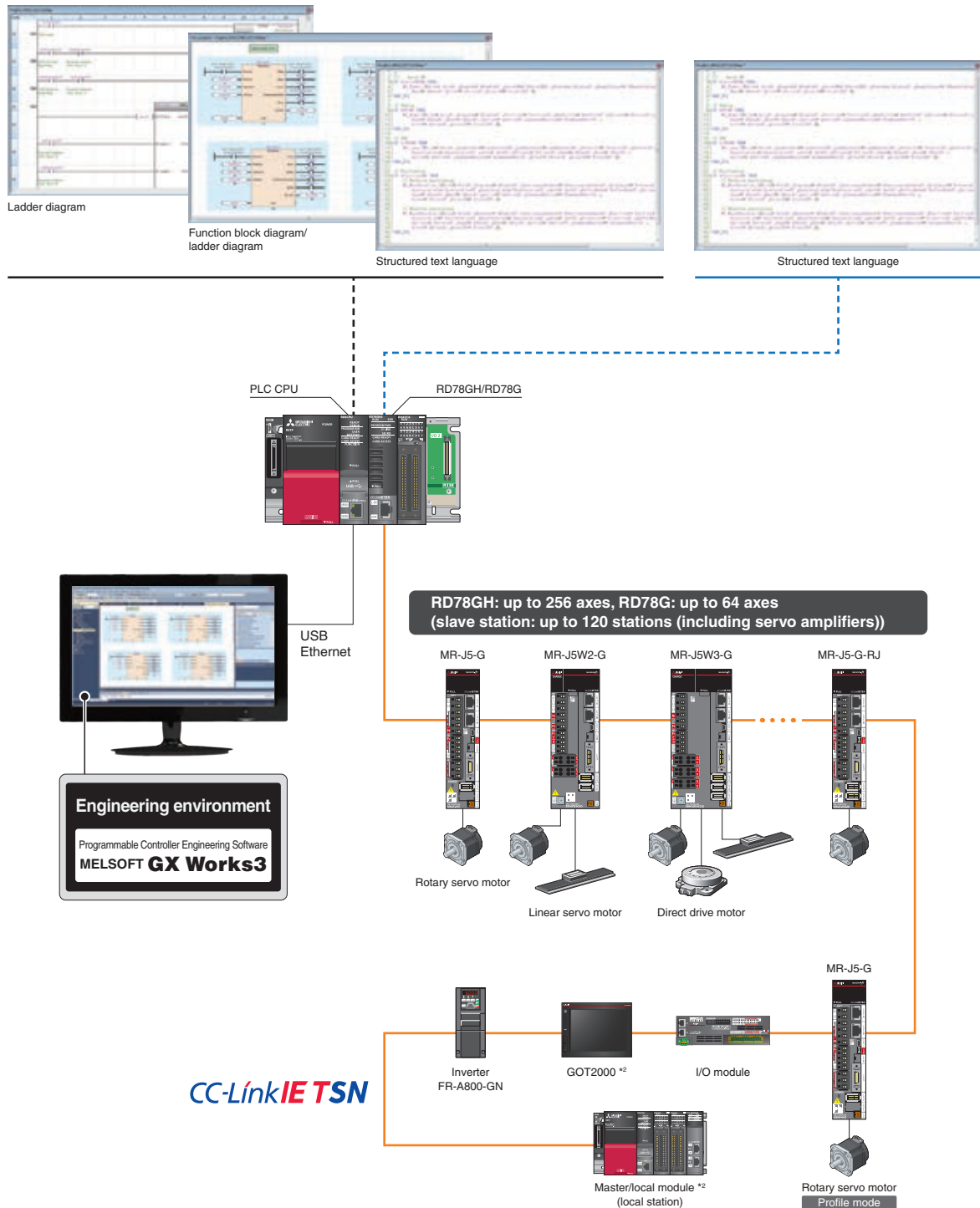

*1. Compared to the master/local module, the Motion modules are not provided with the following functions: sub-master station, local station, multi-master configuration, backup/restore function, and data communication function between general stations.

*2. Future support planned

Control Load Distribution Realized by Flexible Programming

Programming using the internationally standardized PLCopen® Motion Control FBs is possible.

Selectable programming languages vary depending on the controllers:

- Motion module: structured text language (ST)
 - PLC CPU: ladder diagram (Ladder), function block diagram/ladder diagram (FBD/LD), and structured text language (ST).
- Select the controller and programming language according to the necessity of high-speed operation and the complexity of the operation.

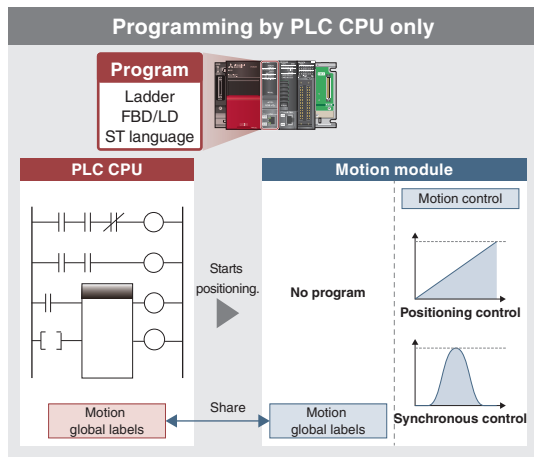

- Reduced programming burden

Perfect for users who prefer to use only PLC CPU programs

A PLC CPU program starts operation of the Motion module, eliminating the need for users to create another program for the Motion module, reducing programming burden.

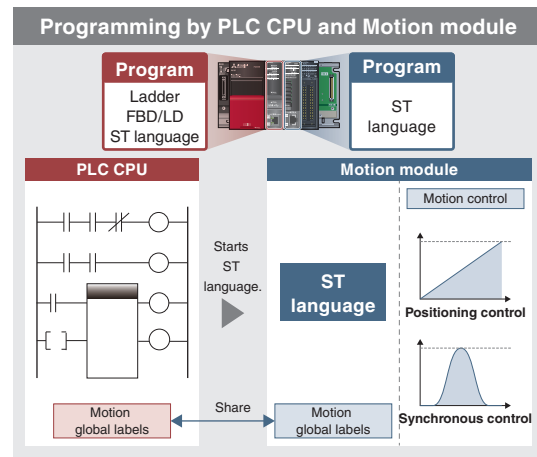

- Control load distribution
- Reduced cycle time

Perfect for demanding applications which require high-speed, complicated motion operation

Motion modules can execute operations in place of the PLC CPUs. This reduces the operation burden on PLC CPUs and results in a shorter cycle time.

Motion Modules for High-Performance Operation

- Two types of Motion modules are available: RD78G for positioning and synchronous control and RD78GH for higher-accuracy control.
- Control load distribution among PLC CPUs and Motion modules is possible: the PLC CPUs execute machine control, and the Motion modules execute motion control.

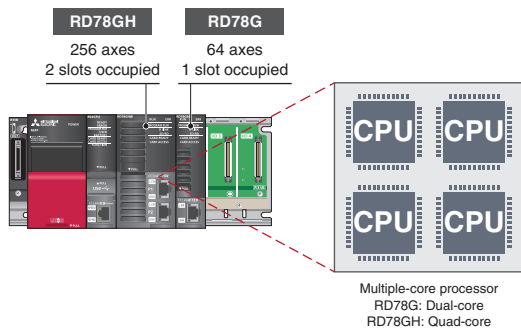

Touch Probe Function (Mark Detection Function)

This function latches data responding to a trigger signal input. The trigger signal can be inputted to the controller using a remote I/O.

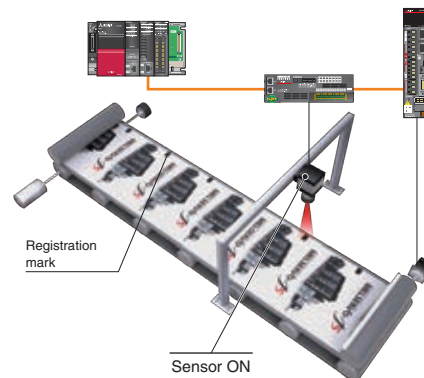

Synchronous Encoder

The Motion module easily performs synchronous control by setting a synchronous encoder to "Real encoder axis" and creating a program with function blocks.

The number of command pulses can be adjusted using the function block (MC_GearIn) or a parameter.

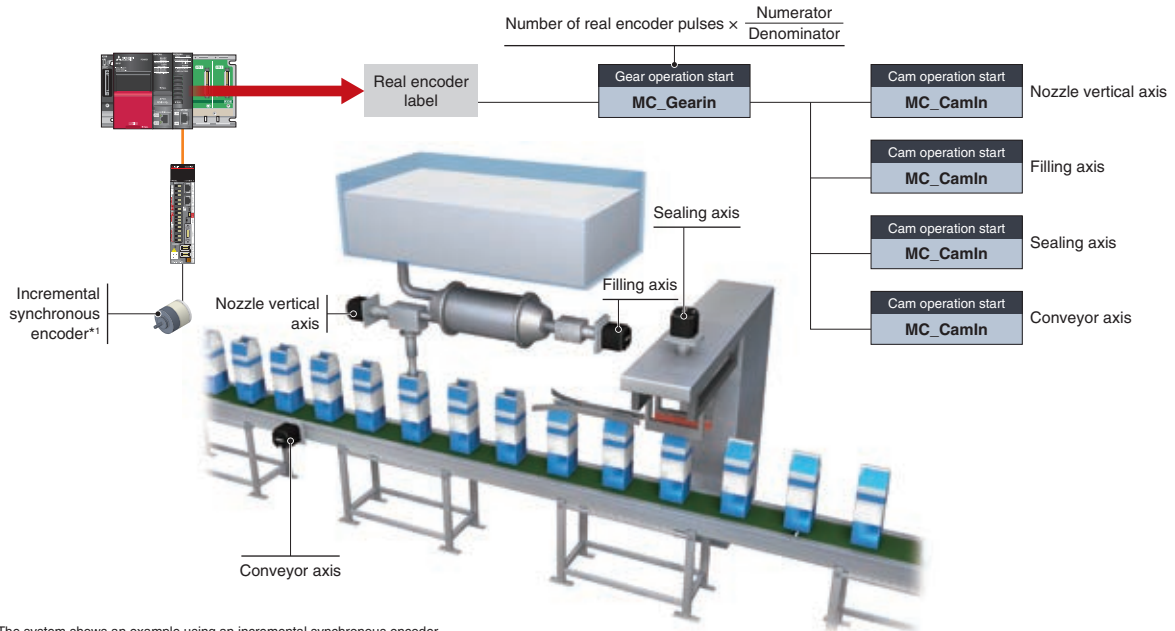

*1. The system shows an example using an incremental synchronous encoder. When configuring an absolute position system, use an encoder of HK series servo motors.

Monitoring of Servo Data

Servo operation is monitored with extensive servo data acquired via CC-Link IE TSN. The acquired data can be transferred to IT system or transferred and displayed on any user-created GOT screen in the network. The target data for monitoring can be flexibly changed during operation.

Real-Time Monitor NEW

Up to 32 collected motion system data can be displayed in real time.

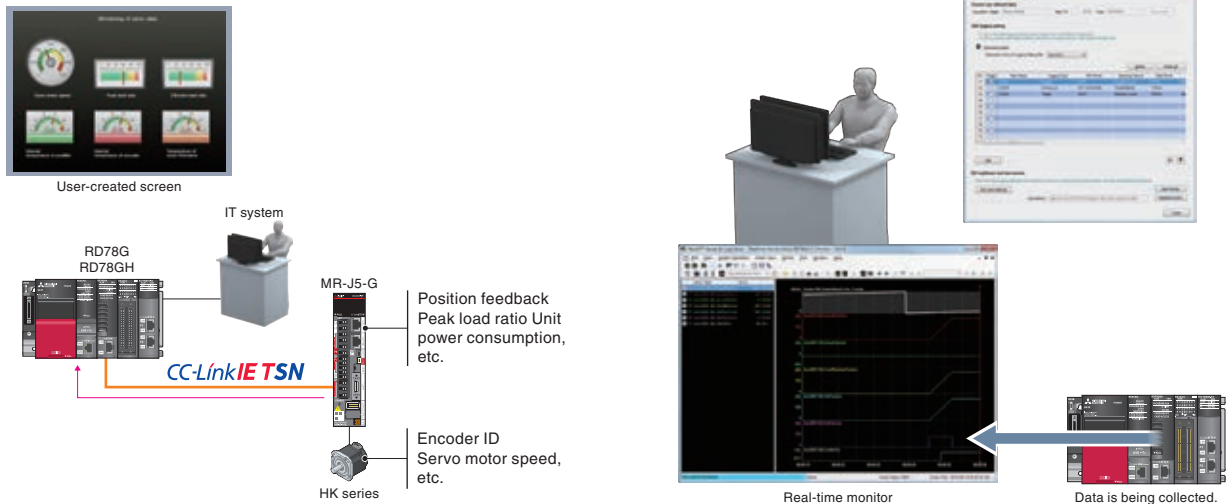

Create new machines together by taking advantage of our innovative IPC environment

CC-Link IE TSN

Motion Control Software

SWM78

Available soon



SWM78 Motion Control Software performs motion and network control through Visual C++®. To perform control, install the software on an industrial personal computer with a real-time operating system.

Product Lines

SWM78

- Creates a CC-Link IE TSN servo system by being installed on an industrial personal computer with a real-time operating system.
- Performs various types of motion control, such as positioning, synchronous, cam, speed, and torque control.
- Meets various application needs by utilizing the API library which has the same interface with PLCopen® Motion Control Function Blocks.



MELSOFT EM78 SDK

- SWM78 Motion Control Software
- API library
- EM Configurator2

CC-Link IE TSN

Motion Control Software

SWM78

Available soon

- Maximum number of control axes: 256 axes
- Minimum operation cycle*1: 250 μ s
- Programming language: Visual C++®

*1. The number of controllable axes varies by the operation cycle.

Operating Environment

- Supports INtime (real-time operating system).
- Operates on an industrial personal computer with the Intel I210 Ethernet Controller.

System Configuration

MELSOFT EM78 SDK API library adopts the same interface as the internationally standardized PLCopen® Motion Control Function Blocks. By calling the API library, a user program executes motion control.

The API library also boasts increased program readability by utilizing the class library format.

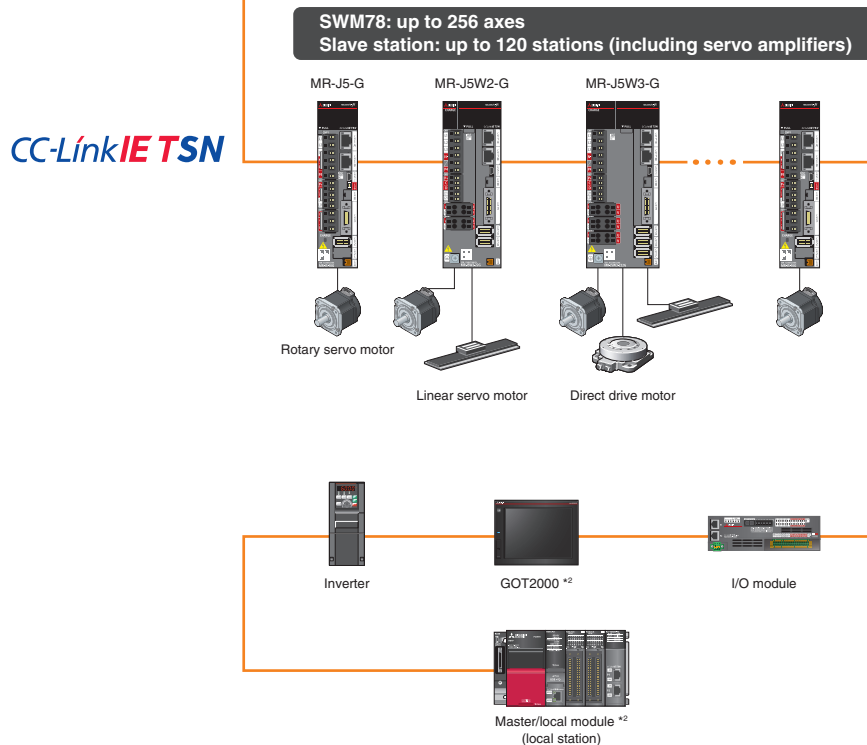
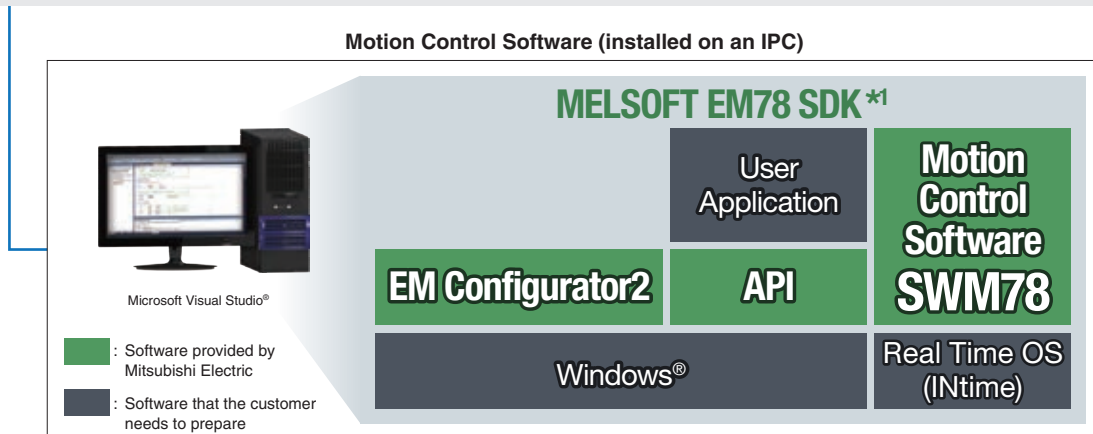
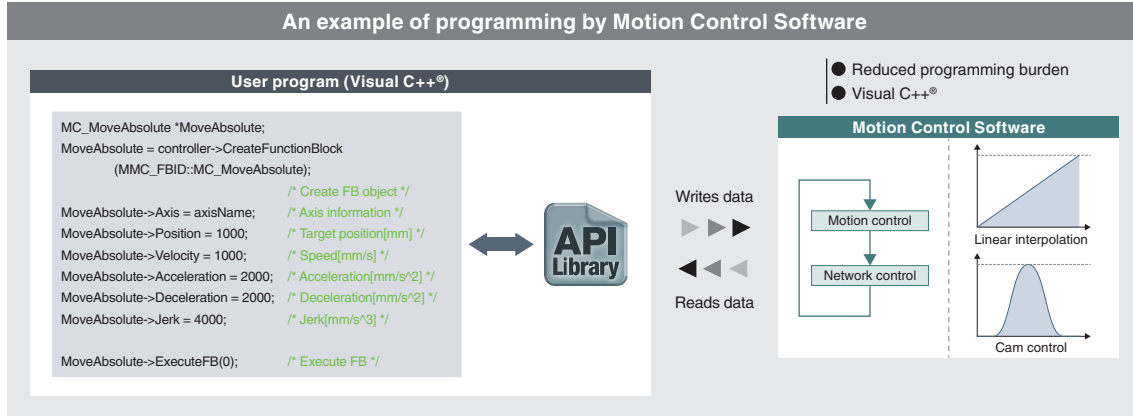

*1. To use Motion Control Software, prepare MELSOFT EM78 SDK and the USB key with license information.

*2. Future support planned

Driving a wider range of motors with more flexible options

Servo Amplifiers

MITSUBISHI ELECTRIC SERVO SYSTEM

MELSERVO-J5



MELSERVO-J5 series servo amplifiers support CC-Link IE TSN, enabling a communication speed of 1 Gbps and a command communication cycle of $\geq 31.25 \mu\text{s}$. The servo amplifier supports a speed frequency response of 3.5 kHz for even smoother control.

Product Lines



CC-Link IE TSN MR-J5-G

Supports Ethernet-based CC-Link IE TSN, featuring high-speed, large-capacity communication (1 Gbps). Command communication cycle of $\geq 31.25 \mu\text{s}$ and speed frequency response of 3.5 kHz enable advanced motion control.



CC-Link IE TSN MR-J5W2-G/ MR-J5W3-G

Drives a maximum of either two to three servo motors. This simplifies wiring, saves energy, and enables a compact machine at a lower cost.



General purpose interface-compatible

MR-J5-A

Enables position control by pulse train command and speed/torque control by analog voltage command. The maximum command pulse frequency is 4 Mpulses/s.



Simple converters

MR-CM

Utilizing a common bus connection conserves energy through the efficient use of regenerative power. Wiring can be simplified, and installation space can be saved by reducing the number of molded-case circuit breakers and magnetic contactors.

●: Supported ○: Future support planned –: Not supported

■: Future release planned

Model	Power supply specifications (Note 1)	Command interface	Fully closed loop control (Note 2)	Compatible servo motors			Capacity		
				Rotary	Linear (Note 3)	Direct drive			
MR-J5-G	200 V AC	CC-Link IE TSN	●	●	●	●	0.1 kW to 7.0 kW		Up to 22 kW
	400 V AC		○	○	○	–	0.6 kW to 22 kW		
MR-J5W2-G	200 V AC	EtherCAT® (Note 4)	●	●	●	●	0.2 kW to 1.0 kW		
MR-J5W3-G	200 V AC		–	●	●	●	0.2 kW to 0.4 kW		
MR-J5-A	200 V AC	Pulse train/	●	●	●	●	0.1 kW to 7.0 kW		Up to 22 kW
	400 V AC	Analog voltage	○	○	○	–	0.6 kW to 22 kW		

Notes: 1. 200 V AC servo amplifiers are compatible with DC power supply input as standard.

2. The indicated servo amplifiers are compatible only with a two-wire type serial encoder. For four-wire type serial encoders and pulse train interface (A/B/Z-phase differential output type) encoders, use MR-J5-G-RJ/MR-J5-A-RJ servo amplifiers.

3. The indicated servo amplifiers are compatible only with two-wire type and four-wire type serial linear encoders. For a pulse train interface (A/B/Z-phase differential output type) linear encoder, use MR-J5-G-RJ/MR-J5-A-RJ servo amplifiers.

4. EtherCAT® is supported by MR-J5-G-N1/MR-J5W2-G-N1/MR-J5W3-G-N1 servo amplifiers.

Tuning Functions

Use the tuning methods that are optimal for your machines.

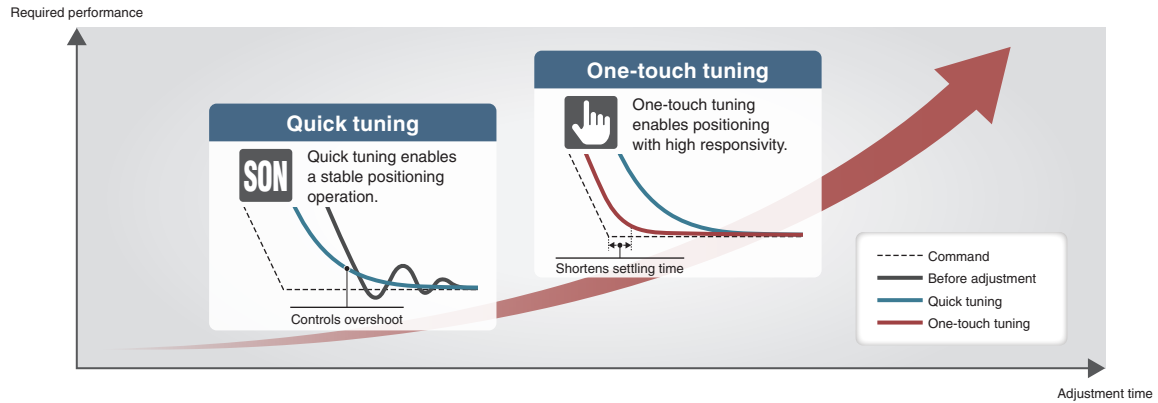

Quick Tuning

This function automatically performs easy-to-use auto tuning that controls vibration and overshoot just by turning on the servo-on command. Before normal operation, the servo amplifier sets control gain and machine resonance suppression filters in 0.3 seconds by inputting torque to the servo motor automatically. After completing the setting, the servo amplifier starts operation normally.

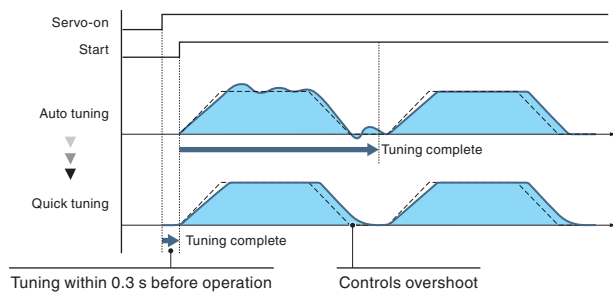

Simple Converter MR-CM

Utilizing a common bus connection conserves energy through the efficient use of regenerative power. Wiring can be simplified and installation space can be saved by reducing the number of molded-case circuit breakers and magnetic contactors. The MR-CM simple converter can connect to up to six compatible servo amplifiers having a total capacity of 3 kW or lower. Wiring for the bus and the control power supply can be simplified by using daisy chain power connectors for passing wiring.

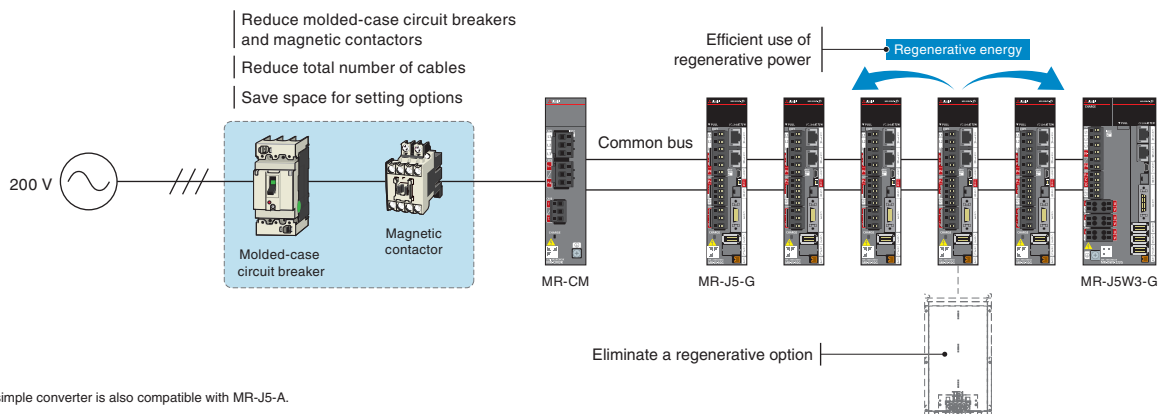

*The simple converter is also compatible with MR-J5-A.

Simple converter (option)

Model	Power supply specifications	Capacity [kW]	Connectable servo amplifiers	Note
MR-CM3K	200 V AC	3	1 to 6 units	Compatible with MR-J5-G/MR-J5W2-G/MR-J5W3-G/MR-J5-A.

A broader selection of capacities to match various applications for smart equipment

Rotary Servo Motors
HK Series

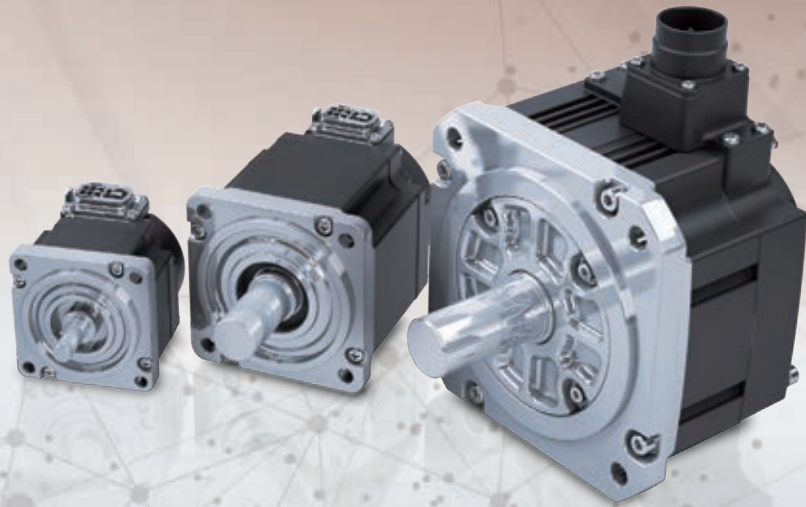

Our broad range of servo motors of capacities allow you to select a servo motor that is perfect for your machines. The HK-KT series boasts a product line that offers 16 models in the 200 V class and 7 models in the 400 V class (total of 23 models, greatly increased from the 5 models in the HG-KR for MR-J4).

Product Lines

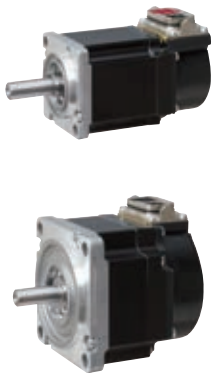

Small capacity, low inertia

HK-KT Series

Servo motors with a 26-bit batteryless absolute position encoder
 Rated speed: 3000 r/min *1
 Maximum speed: 6700 r/min *1
 Our product lines includes 400 V and flat type models.
 The servo motors have an all-in-one connector, making the connection simple.

*1. The speed varies by the model type.

5 kW, 7 kW added

Medium capacity, medium inertia

HK-ST Series



Servo motors with a 26-bit batteryless absolute position encoder
 Rated speed: 2000 r/min *1
 Maximum speed: 4000 r/min *1
 The cables for the encoder, the electromagnetic brakes, and the power are equipped with one-touch lock.

*1. The speed varies by the model type.

Series	Inertia	Motor type	Servo amplifier power supply	Power Range	Future release
HK-KT	Low inertia	HK-KT_W	200 V AC	0.05 kW to 2.0 kW	
			400 V AC	0.05 kW to 2.0 kW	
		HK-KT_4_W	200 V AC	0.2 kW to 1.0 kW	
			400 V AC	0.4 kW to 2.0 kW	
HK-ST	Medium inertia	HK-ST_W	200 V AC	0.5 kW to 7.0 kW	Up to 11 kW
			400 V AC	0.5 kW to 11 kW	
		HK-ST_4_W	200 V AC	0.3 kW to 4.2 kW	Up to 5.5 kW
			400 V AC	0.5 kW to 11 kW	

■ : Future release planned

Notes: The motor types are classified by the power class (200 V or 400 V) of the servo motors. The servo motors can be driven regardless of the servo amplifier power supply.

Batteryless Absolute Position Encoder as Standard

Servo motors come equipped with a batteryless absolute position encoder as standard, making it possible to configure absolute position systems without the use of batteries or any other options. Moreover, maintenance costs are reduced as a result of eliminating the battery replacement and stock control.

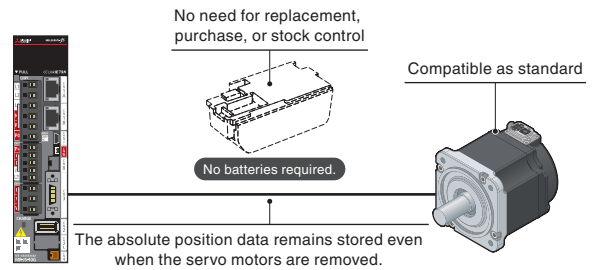

Single Connector/One-Touch Lock/Single Cable Type

HK-KT Series: Single Connector/Single Cable Type/One-Touch Lock

The single connector for the HK-KT series combines the motor power supply, encoder, and electromagnetic brake into a single cable. The one-touch lock eliminates the need for tightening screws, making wiring easy. The servo motors are also compatible with the dual cable type. The cables can be mounted either horizontally or vertically according to your selection.

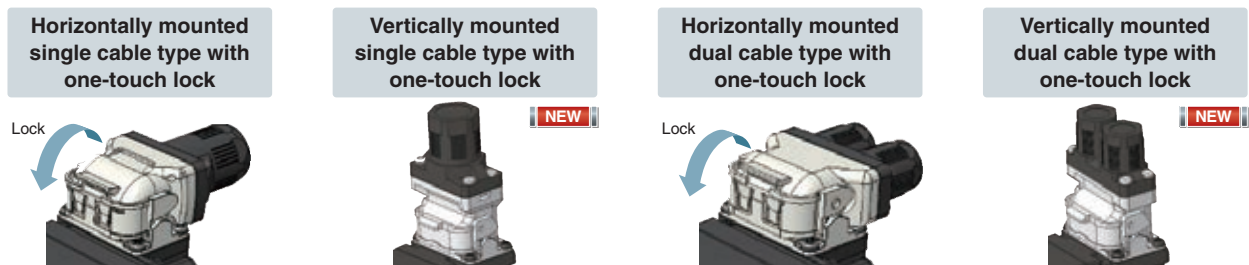

HK-ST Series: One-Touch Lock

HK-ST series servo motors boast a greatly simplified installation process through use of the one-touch lock system. The one-touch lock can be used to mount connectors for the motor power supply, encoder, and electromagnetic brake, which eliminates the need for tightening screws. The HK-ST series is compatible with both straight and angle type connectors and also supports traditional screw-tightened connectors.

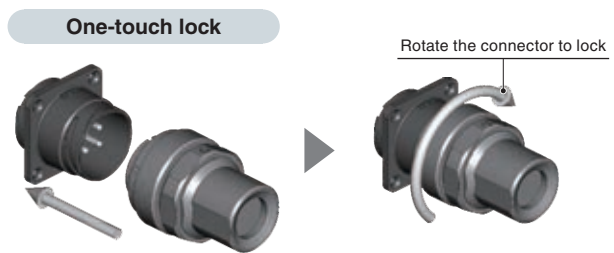

Compact Servo Motors with a Batteryless Absolute Position Encoder

HK-KT series servo motors come equipped with a batteryless absolute position encoder and are more compact than the previous generation HG-KR series. Flat types are also available in the HK-KT product line, contributing to a compact machine design.

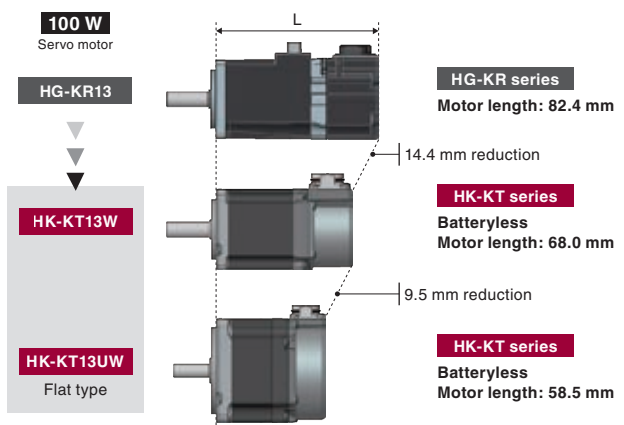

Expanding Combinations of Servo Amplifiers and Servo Motors

Increases Maximum Torque by Combining with Larger-Capacity Servo Amplifiers

It is possible to increase the maximum torque and achieve a shorter cycle time by combining the servo motor with a larger-capacity servo amplifier.

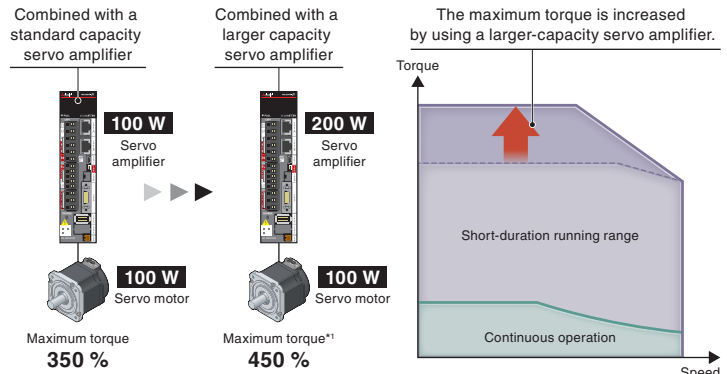

Drives Smaller Capacity Servo Motors

Servo amplifiers are able to drive servo motors with a smaller capacity than the servo amplifier being used, reducing the kinds of spare parts that are needed.

For example, 400 W servo amplifiers are compatible with the following servo motors: 50 W, 100 W, 150 W, 200 W, and 400 W models.

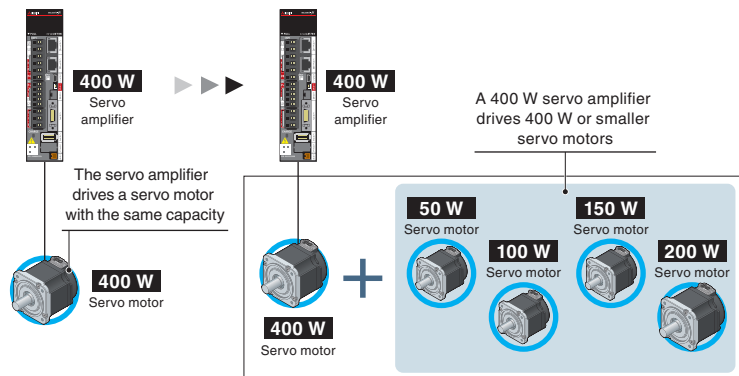

Drives 200 V/400 V Class Servo Motors

The 200 V servo amplifiers can drive both 200 V and 400 V servo motors, and the 400 V servo motors may produce torque that is sufficient for operation when combined with smaller-capacity 200 V servo amplifiers. Lowering of the capacity of the servo amplifier contributes to lower costs and reduced installation space.

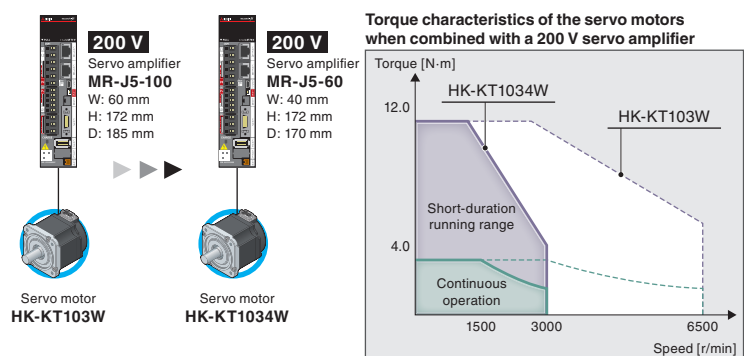

EtherCAT® J5-G-N1 J5W2-G-N1 J5W3-G-N1

EtherCAT®-compatible servo amplifiers are available, enabling higher-performance MR-J5 servo amplifiers with enhanced functions on the EtherCAT® system. MR-J5-G-RJN1/MR-J5W2-G-N1/MR-J5W3-G-N1 support the touch probe. (Latch accuracy: 1 μs)



Drive System Sizing Software "Motorizer"

Select the most suitable servo motors, servo amplifiers, and regenerative options for your machine just by setting machine specifications and operation patterns. You can select a suitable combination from various results. This software also supports multi-axis systems, enabling you to set operation patterns and select options for multiple axes.

The screenshot shows the Motorizer software interface. It includes a 'Specification input' section with fields for Mass of load, Mass of table, Counter weight mass, Load of ball screw, Ball screw inertia moment, Friction coefficient, Overall machine efficiency, and Thrust load. A 'Navigation' sidebar on the left contains icons for Step 1 (Load mechanism), Step 2 (Transmission mechanism), Step 3 (Operation pattern), Filter Setting, Motor selection, and Drive selection. A 3D diagram of a load mechanism is shown with labels JOL, JOM, W_L, W_{CW}, F_C, and P_b. A 'Selection candidate list' table is displayed at the bottom, showing columns for Motor, Motor capacity, Drive, Drive capacity, Torque effective load rate, Peak load rate, and Effective load rate. A callout box notes: '13 common load mechanisms' and 'Able to add mechanical transmissions'. Another callout notes: 'The selection result displays various possible options.'

Flexible support for load mechanisms Enhanced functions

- Select a load mechanism from 13 common types. (A crank mechanism is newly added.)
- Add transmission mechanisms such as a coupling.
- Set an inclination angle of the load mechanisms as desired.

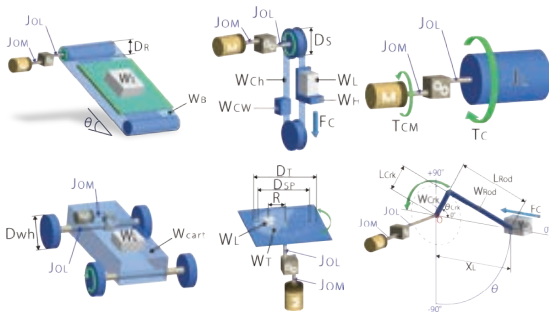

Selection of several patterns

- Displays a list of load to motor inertia ratio, peak torque, etc., of each selection.
- Compatible with the expanded combinations of the servo amplifiers and the servo motors.
- Set threshold values for judgement.
- Displays energy-saving effect by multi-axis system

Motor	Motor capacity(kW)	Drive	Drive capacity(kW)	Torque effective load rate(%)	Peak load rate(%)	Effective load rate at	Motor output ratio(%)
HE-4713(W)	0.130	MR-S-200-A	0.200	100	77.8	100	100
HE-4713(W)	0.130	MR-S-200-A	0.200	100	77.8	100	100
HE-4713(W)	0.130	MR-S-200-A	0.200	100	116.7	100	100
HE-4713(W)	0.130	MR-S-200-A	0.200	100	116.7	100	100
HE-4713(W)	0.200	MR-S-200-A	0.200	100	116.7	100	100

Compatible with multi-axis systems

- Supports the multi-axis servo amplifiers and the converters.
- Set operation patterns for multiple axes.
- Select regenerative options for a multi-axis system.

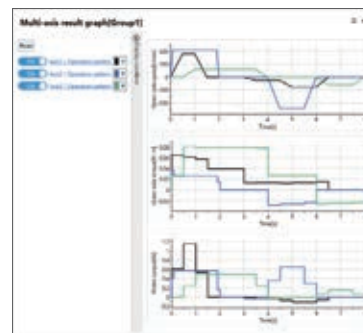

Tutorial video

- Illustrates how to use the software and select drive systems in the video.



Open integrated networking across the manufacturing enterprise

CC-Link IE TSN

CC-Link IE TSN supports TCP/IP communications and applies it to industrial architectures through its support of TSN enabling real-time communications. With its flexible system architecture and extensive setup and troubleshooting features make CC-Link IE TSN ideal for building an IIoT infrastructure across the manufacturing enterprise.

* TSN: Time Sensitive Networking
 * IIoT: Industrial Internet of Things

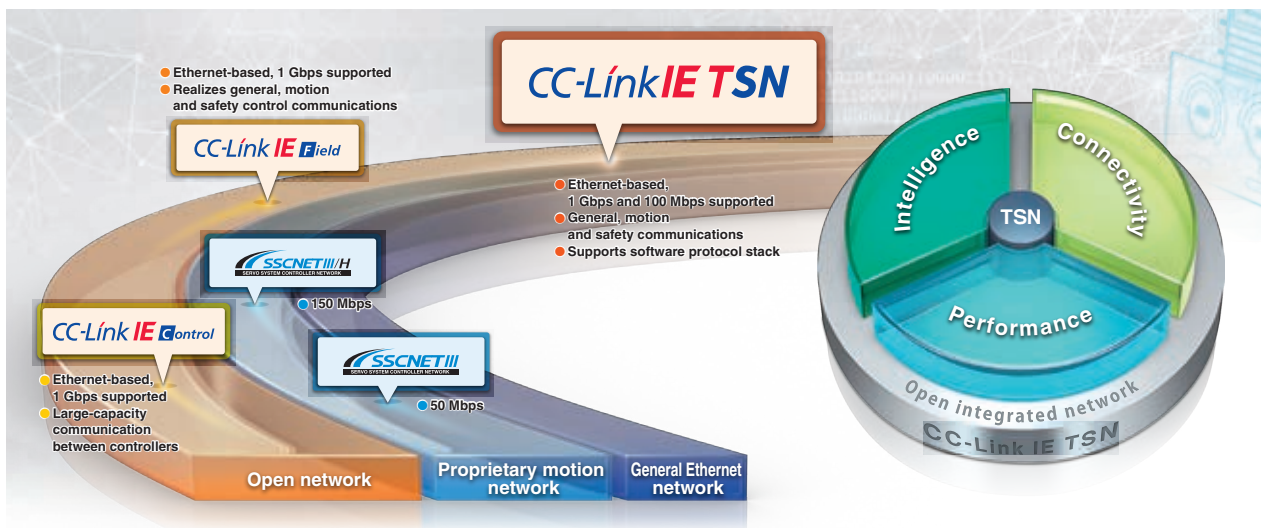

Real-Time Network Performance Even When Integrated with Information Data

TSN technology enables mixing of deterministic communications with IT system information data on the same network. Giving higher priority to CC-Link IE TSN cyclic communications and TCP/IP communications by allocating increased network bandwidth, devices using general Ethernet communications can be connected on the same network while maintaining real-time control communication performance.

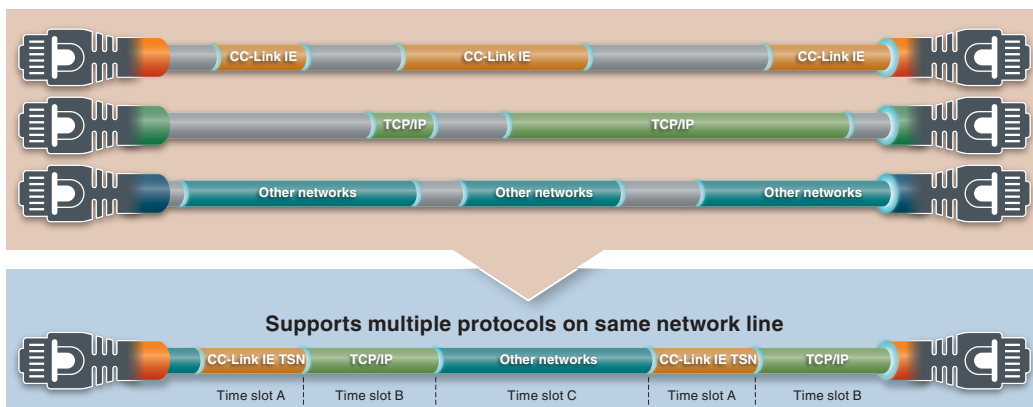

Deterministic Control Even When Mixed with TCP/IP Communication

Deterministic performance of cyclic communication is maintained even when mixed with information data (non real-time). This enables TCP/IP communication devices to be used without affecting overall control.

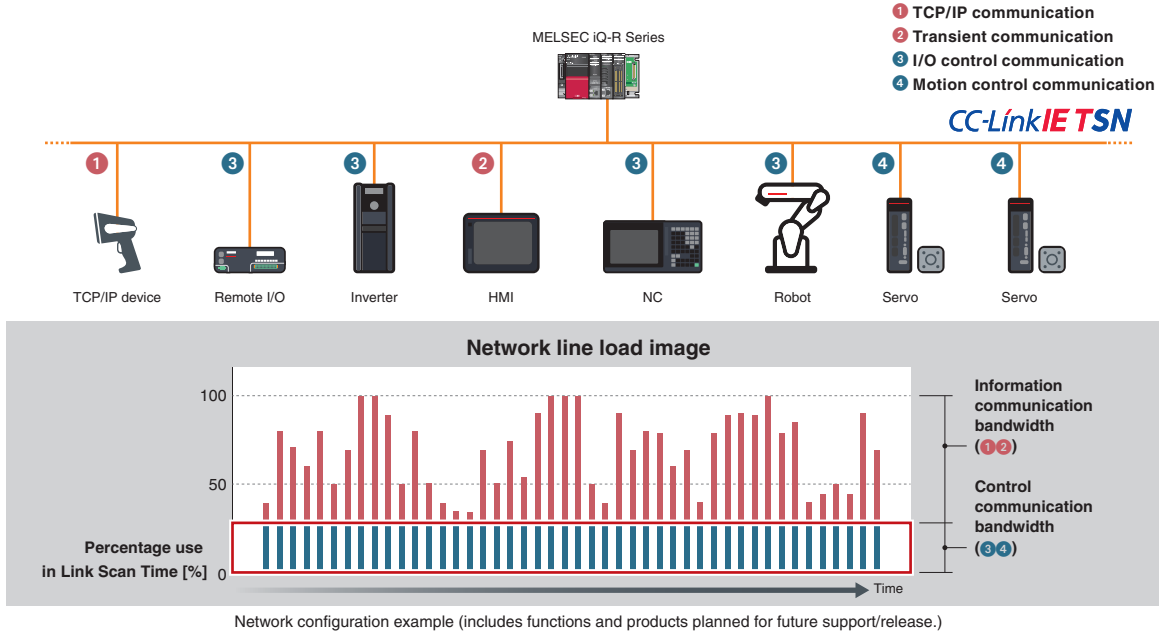

Integrated Network

Current network systems use multiple networks to enable communication between IT and control systems on the shop floor. CC-Link IE TSN is a one-stop solution for integrating different networks, thereby realizing flexibility in topology and reducing wiring cost.

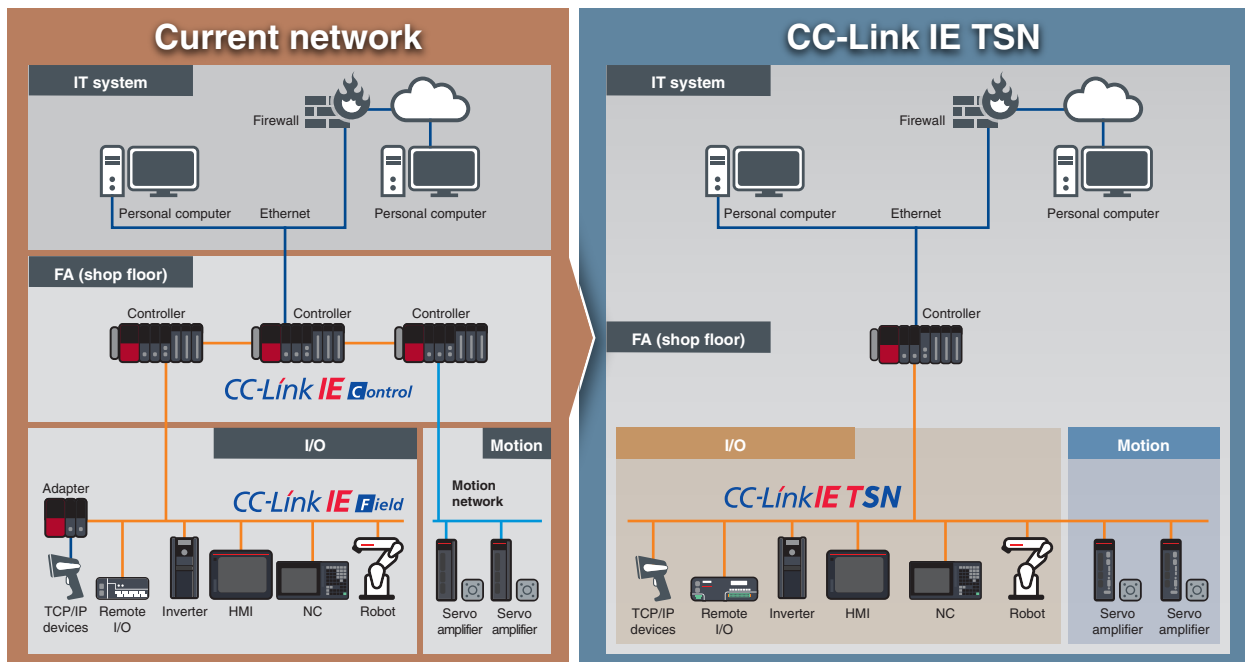

Network configuration example (includes functions and products planned for future support/release.)

High-Speed, High-Accuracy Motion Control

CC-Link IE TSN controls I/O modules while also maintaining high-speed motion control. The single network boosts machine performance.

- Motion control (high-speed processing)
- I/O control (low-speed processing)

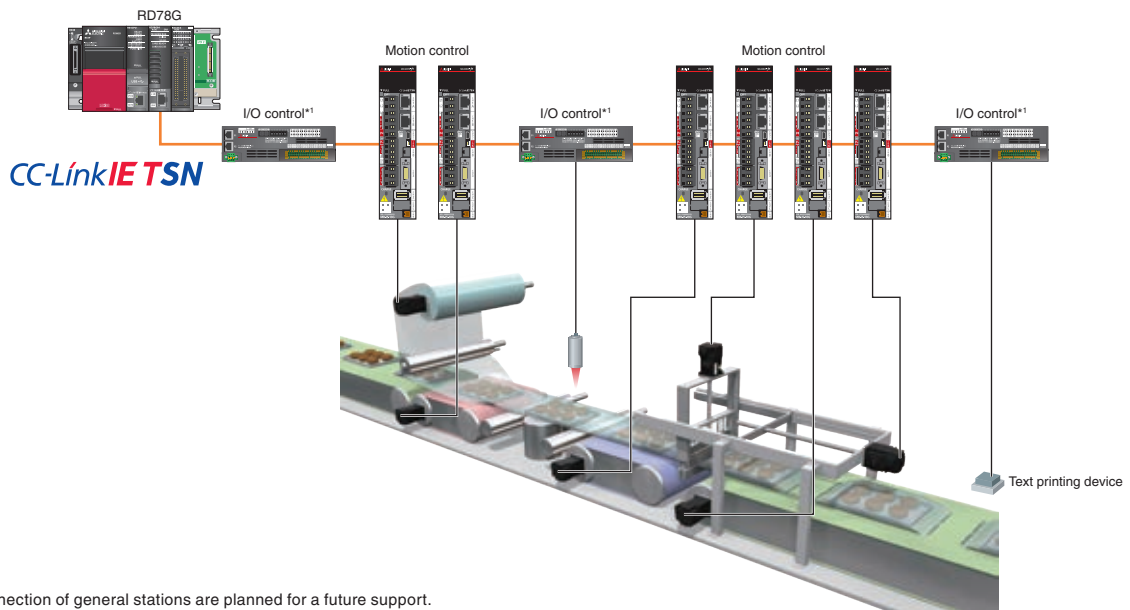

*1. The connection of general stations are planned for a future support.

Time Synchronization

Set time is completely synchronized among servo amplifiers, Motion modules, and PLC CPUs. This time synchronization enables accurate recording of the event history in chronological order, making it simple to identify the cause of errors.

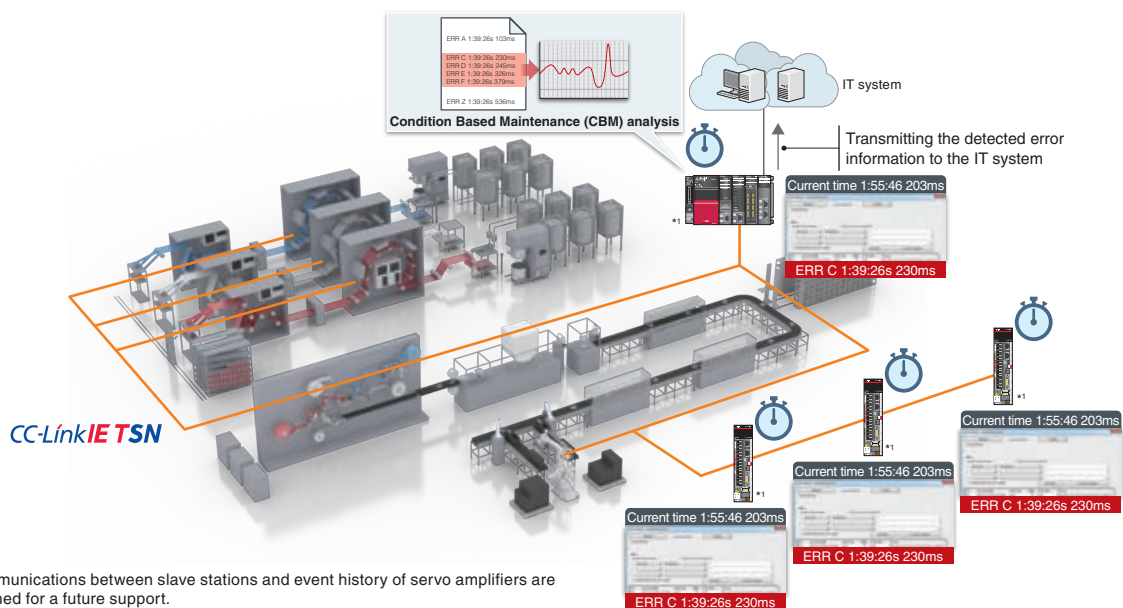

*1. Communications between slave stations and event history of servo amplifiers are planned for a future support.

Seamless Connectivity Between TCP/IP Devices and a Servo System

TCP/IP communication (information communication) can be mixed in the same line with the real-time control communications of CC-Link IE TSN.

CC-Link IE TSN slave devices and TCP/IP devices can be connected on the same network, achieving a flexible and integrated network system. Note that the TCP/IP devices must be connected after servo amplifiers and I/O modules.

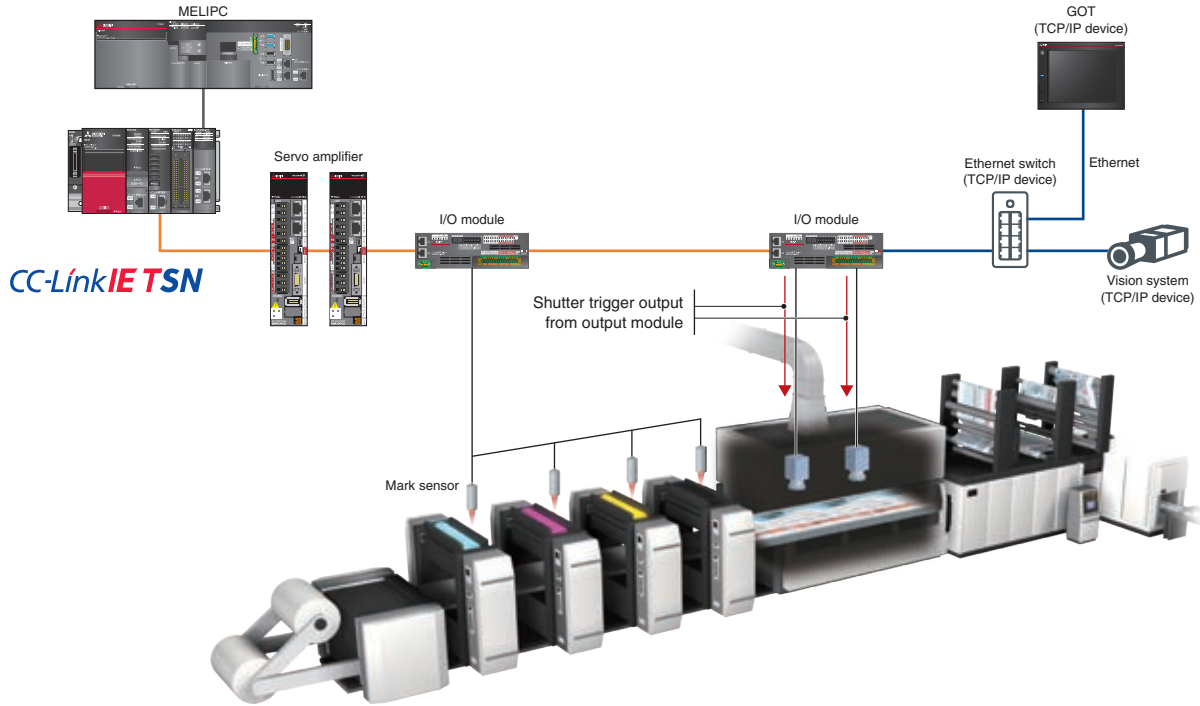

Large-Capacity Data Communications

CC-Link IE TSN is a high-speed, large-capacity 1 Gbps communications network that is capable of sending and receiving large amounts of data, such as manufacturing, quality, and control data from the production process. The network can transmit large recipe data or traceability data at high speeds without degrading the performance of servo system communications. In addition, Ethernet supported devices can directly and seamlessly connect to controllers on the same network line.

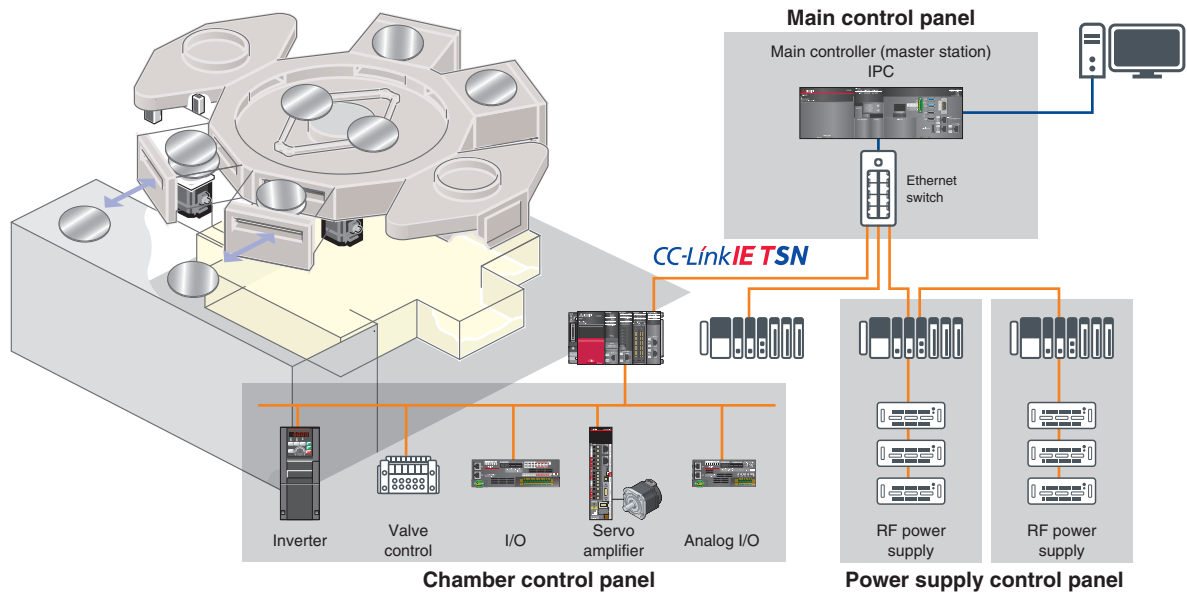

Network configuration example (includes functions and products planned for future support/release.)

Simple maintenance

Comprehensive diagnostic functions contribute to improved maintenance

Increasing the capacity of your production line is an important factor in this fiercely cost-competitive market. The MELSERVO-J5 series servo system provides various kinds of maintenance functions that predict and prevent unforeseen problems and enable quick recovery when trouble arises. These functions contribute to reduced downtime and increased productivity while protecting the quality of your products.

MELSERVO-J5 series servo amplifiers and servo motors are equipped with various predictive and preventative maintenance functions.

Predictive Maintenance (CBM)

Predictive maintenance, also known as Condition Based Maintenance (CBM), is the practice of detecting changes in machine vibration and friction so that parts can be replaced accordingly before they fail. Performing predictive maintenance leads to increased machine capacity and helps to avoid downtime, reduce maintenance time, and improve both productivity and product quality.

Detects Changes in Vibration and Friction to Predict the Service Life of Mechanical Drive Components

[Machine diagnosis function]

The machine diagnosis function detects age-related deterioration based on the frictions and vibrations of mechanical drive components such as ball screws, belts, and gears. This function automatically generates a failure warning limit, detects errors, and outputs a warning upon signs of failure. Results of the failure are transmitted via CC-Link IE TSN to the motion module and IT system and can be used for maintenance and overall machine diagnostics.

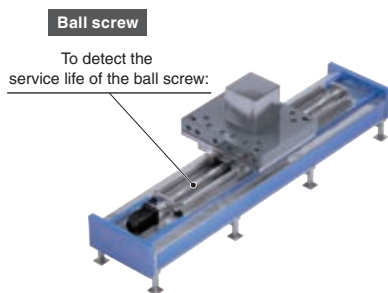

- Friction failure prediction with the friction estimation function
- Vibration failure prediction with the vibration estimation function

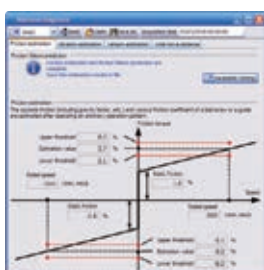

Estimated friction value is displayed.

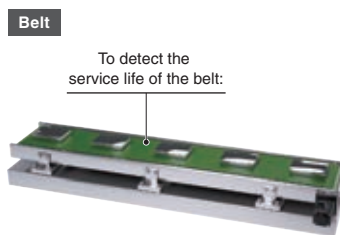

- Static friction failure prediction
- Belt tension deterioration prediction

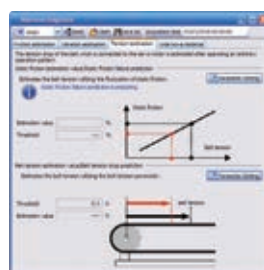

Estimated static friction and belt tension are displayed.



- Backlash estimation function
- Gear failure prediction



Estimated backlash value is displayed.

Preventative Maintenance (TBM) *1

*1. TBM stands for Time Based Maintenance.

Machine Diagnosis (Mechanical Drive Components)

This function estimates when a machine failure will occur based on the total travel distance of the servo motor, and notifies when it is time for replacement if the rated life of the mechanical drive components is set.

- Machine total travel distance failure prediction

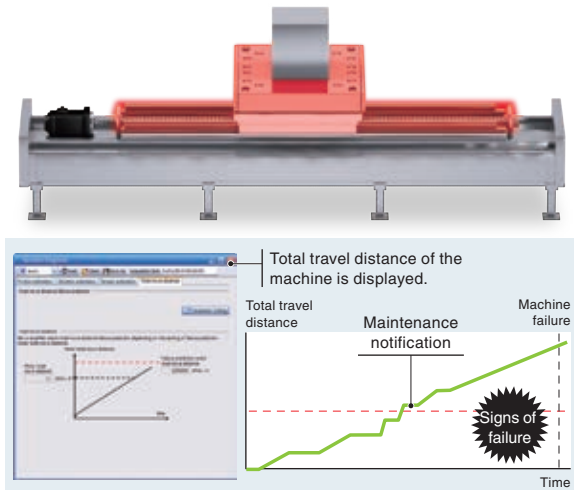

Servo Amplifier Life Diagnosis

This function displays the cumulative energization time and the number of inrush relay on/off times. The data can be used to check life of the parts as a rough guide.

- Cumulative energization time (Smoothing condenser/cooling fan life span)
- The number of inrush relay on/off times (Inrush relay life)



Disconnection Detection

The servo amplifiers are equipped with both input open-phase detection and output open-phase detection. Input open-phase detection detects an open phase of the main circuit power supply of the servo amplifier, and output open-phase detection detects an open phase of the servo motor power supply. The alarm can be distinguished from other alarms such as the overload alarm, reducing the time required to restore the system.

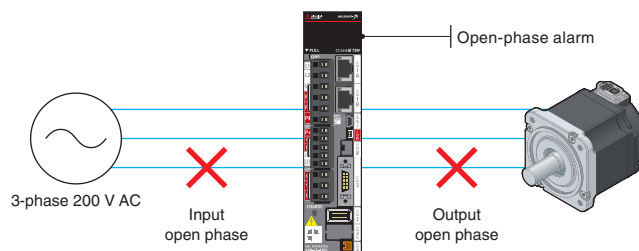

Servo Motor Incorrect Wiring Detection

J5W2-G J5W3-G

Multi-axis servo amplifiers MR-J5W2-G/MR-J5W3-G detect servo motors with a different capacity that are incorrectly connected to the A-axis/B-axis/C-axis, contributing to servo motor protection. The servo amplifiers obtain servo motor capacity information of the connected servo motors from the encoders and check whether the servo motors which are connected to the power connectors match the capacity information. If the information is not matched, an alarm occurs. *1

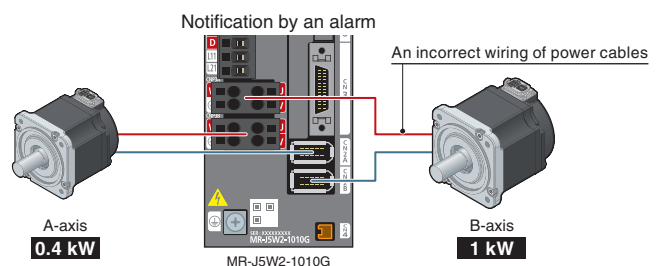

*1. The incorrect wiring detection does not work for servo motors with the same capacity.

Corrective Maintenance

Servo System Recorder

NEW

The Motion module automatically collects data of all real drive axes when an error occurs. The collected data, such as the command and the feedback values, greatly helps you analyze the error cause.

- Automatic collection of data, such as the command and feedback values, without programming
- Data collection of all axes, which helps you locate the error cause even when the error is caused by the other axes without an error

[Data collection]

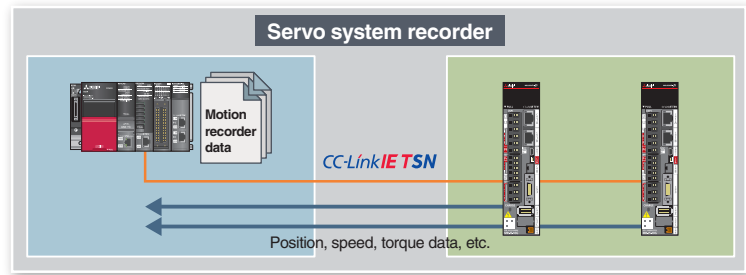
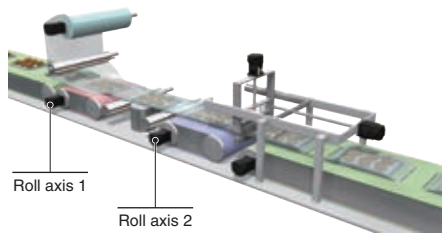

GX LogViewer

GX LogViewer

The collected data of the Motion module is displayed on GX LogViewer.

The operation status of the Motion module and the servo amplifiers before and after an error is displayed in waveform, which allows you to analyze more operation details and helps you locate the error cause.

[Features]

- Displays the collected data and events graphically.
- Enables users to adjust a graph easily by automatic adjustment function and drag operation.

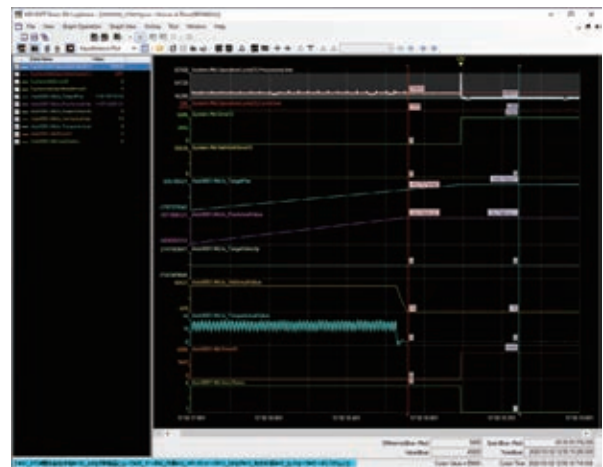

Analyzing Data

Analyzing operation transition of the Motion modules and the servo amplifiers before and after an error helps you locate the error cause.

[Example]

1. An error has occurred.
2. The speed and torque dropped to 0 even though the Motion module outputted commands.

By analyzing the data in the recorder (1 and 2 above), users can find out a possible cause of the error, such as a disconnection of a power cable during operation.

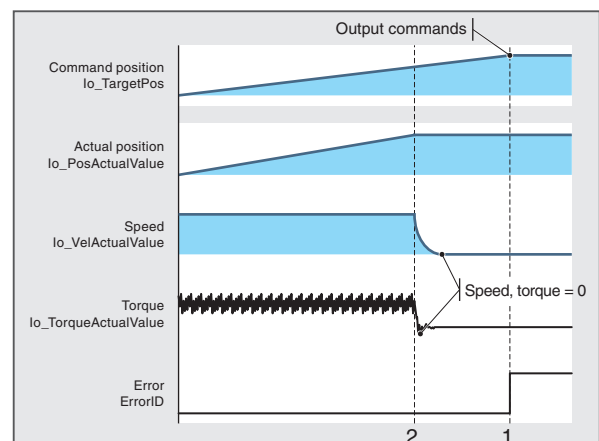

Safety Sub-Functions

Enhanced functions

Built-In Safety Functions and a Wide Range of Safety Sub-Functions J5-G-RJ

MR-J5-G-RJ has a built-in safety control part, supporting safety sub-functions without a dedicated unit. When the servo amplifier is combined with HK-KT_WS/HK-ST_WS servo motors with functional safety, the safety level is enhanced.

The servo amplifiers support the safety sub-functions of STO/SS1/SS2/SOS/SBC/SLS/SSM/SDI/SLI/SLT at a safety level of SIL 2 or SIL 3.

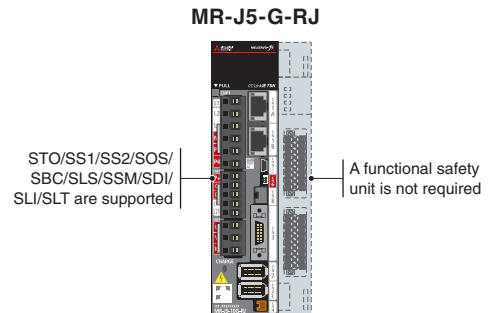

Servo motors with functional safety support the safety sub-functions at a higher safety level. The functional safety encoders provide the servo motor positions and speeds necessary for the safety sub-functions at a safety level of Category 4 PL e, SIL 3.

Encoder cables for the servo motors with functional safety are the same as for the standard servo motors.

Servo motor with functional safety HK-KT_WS/HK-ST_WS NEW

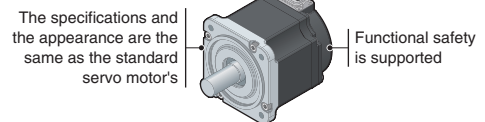

Safety Communication via CC-Link IE TSN J5-G-RJ

CC-Link IE TSN enables control of safety and non-safety communications realizing a flexible system whereby safety communications can be easily incorporated into the main control network.

When combined with R_SFCPU-SET safety CPU and RD78G Motion module, MR-J5-G-RJ can receive safety signal data of the safety CPU through CC-Link IE TSN. Wiring the safety signals to the servo amplifiers is not necessary.

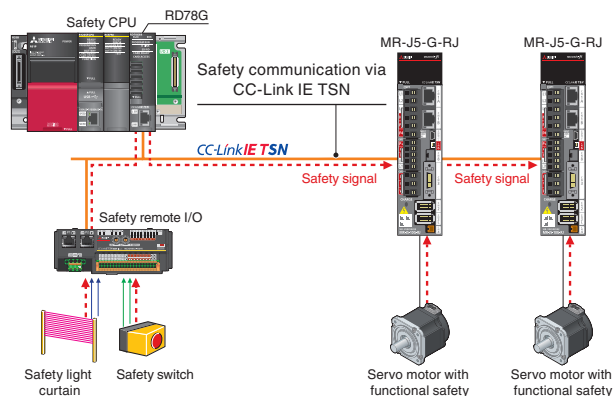

STO Function Compliant with IEC/EN 61800-5-2

STO (Safe torque off) is integrated as standard, enabling easy configuration of a safety system which shuts off power to a servo motor in the machine. The STO function can be set for each axis with MR-J5W2-G/MR-J5W3-G.

- By using STO, it is not necessary to turn off the control power of the servo amplifier, resulting in a shorter restart time and eliminating the necessity of homing.
- A magnetic contactor for preventing unexpected motor start is not needed.*1

Servo amplifier model	Safety level
MR-J5-G/MR-J5-A/MR-J5-A-RJ	Category 3 PL e, SIL 3
MR-J5-G-RJ/MR-J5W2-G/MR-J5W3-G	Category 4 PL e, SIL 3 *2

*1. Magnetic contactors are not required to meet the STO requirements. However, this illustration recommends the use of a magnetic contactor which shuts off the main circuit power supply of the servo amplifier at an alarm occurrence.

*2. The safety level requires STO wiring to a servo amplifier using safety equipment including a safety programmable controller that is compatible with Category 4. When a switch is connected directly to a servo amplifier as shown in the illustration, the safety level is Category 3. For details of safety sub-functions, refer to "MR-J5 User's Manual".

[Shut-off by STO]

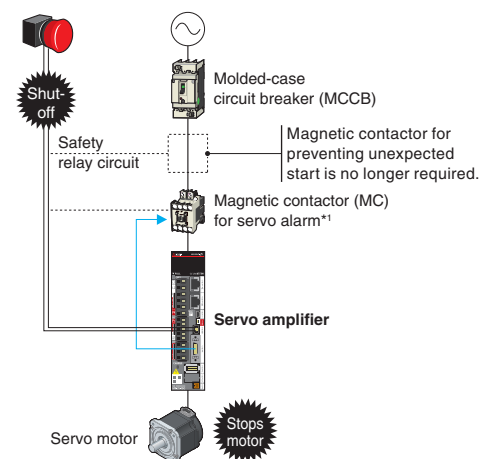

Application Examples

Smooth Production Restart by Utilizing Safe Stop 2 (SS2) and Safe Operating Stop (SOS) Functions

An operator-safe work zone is ensured by providing an exclusion fence around the production robots or stopping the production line when activating the STO Safe Torque Off function (shuts off power to the servo motors responding to the input signal from a safety light curtain or switch). With MELSERVO-J5 series, the zone can be ensured by utilizing SS2 and SOS functions that enable the production line to stop while power to the servo motors is kept supplied, enabling a smooth production restart and ensuring improved productivity without compromising safety.

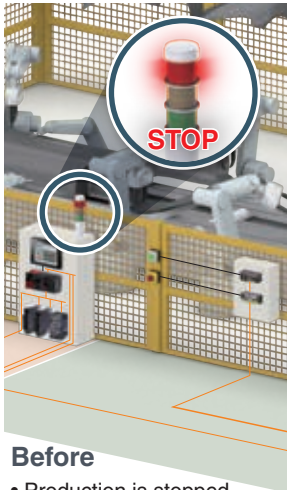

Before

- Production is stopped when STO is activated
- Restart requires more time

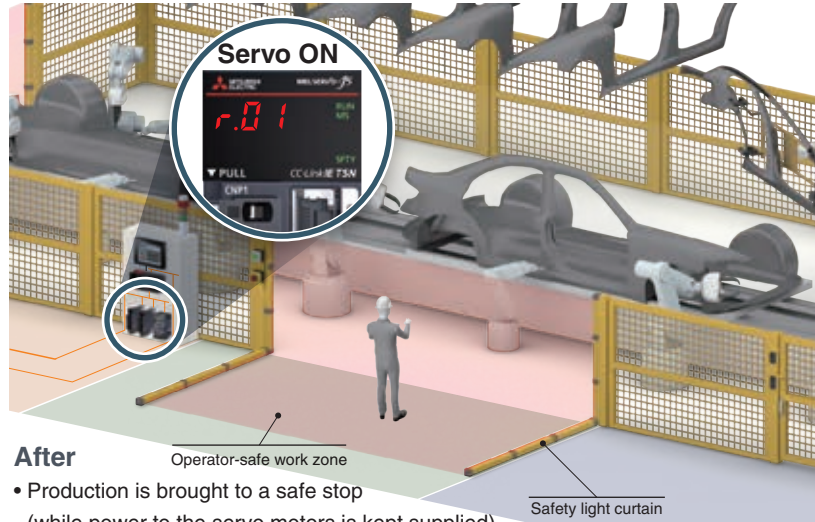

After

- Production is brought to a safe stop (while power to the servo motors is kept supplied)
- Reduction in production restart time

Safety Level Combinations ^(Note 1)

When combined with R_SFPCPU-SET safety CPU and Motion module, MR-J5-G-RJ can receive safety signal data of the safety CPU through CC-Link IE TSN.

Servo amplifier		MR-J5-G-RJ			
Servo motor		Servo motor with functional safety (HK-KT_WS/HK-ST_WS)		Rotary servo motor (HK series), linear servo motor (LM series), direct drive motor (TM series)	
Functional safety category (IEC/EN 61800-5-2)		Cat. 4 PL e, SIL 3	Cat. 3 PL d, SIL 2	Cat. 4 PL e, SIL 3	Cat. 3 PL d, SIL 2
STO	Safe torque off	●	–	●	–
SS1-t	Safe stop 1, time controlled	●	–	●	–
SS1-r ^(Note 2)	Safe stop 1, ramp monitored	●	–	–	●
SS2-t ^(Note 2)	Safe stop 2, time controlled	●	–	–	–
SS2-r ^(Note 2)	Safe stop 2, ramp monitored	●	–	–	–
SOS ^(Note 2)	Safe operating stop	●	–	–	–
SBC	Safe brake control	●	–	●	–
SLS ^(Note 2)	Safely-limited speed	●	–	–	●
SSM ^(Note 2)	Safe speed monitor	●	–	–	●
SDI ^(Note 2)	Safe direction	●	–	–	●
SLI ^(Note 2)	Safely-limited increment	●	–	–	–
SLT	Safely-limited torque	–	●	–	●

Notes: 1. There are some restrictions on the functional safety. Refer to "Safety Sub-Functions" in section 1 of "MELSERVO-J5 Catalog (L(NA)03179ENG)" for details.
 2. A fully closed loop system does not support SS1-r, SS2, SOS, SLS, SSM, SDI, and SLI.

Safety Sub-Functions Compliant with IEC/EN 61800-5-2



MR-J5-G-RJ supports safety sub-functions, STO/SS1/SS2/SOS/SBC/SLS/SSM/SDI/SLI/SLT.

Refer to "Safety Sub-Functions" in section 1 of "MELSERVO-J5 Catalog (L(NA)03179)" for the safety sub-functions and the safety levels, which vary depending on the combinations of the servo amplifiers and the rotary servo motors (including servo motors with functional safety)/linear servo motors/direct drive motors.

<p>Safe torque off (STO)</p> <p>Responding to the input signal from external equipment, the STO function shuts off power to the servo motor electronically using the internal circuit (shuts off through secondary-side output). This function corresponds to the Stop category 0 of IEC/EN 60204-1.</p> <p>Execute the STO function in servo off state or when the servo motor is stopped.</p>	<p>Safely-limited speed (SLS)</p> <p>This function monitors the speed of the servo motor not to exceed the specified speed limit. If the speed exceeds the limit, the motor power is shut off by the STO.</p>
<p>Safe stop 1 (SS1)</p> <p>Responding to the input signal from external equipment, the servo motor starts to decelerate. After the set delay time for motor stop is passed, the STO function starts. Monitoring the servo motor deceleration based on the motor deceleration rate is also supported. This function corresponds to the Stop category 1 of IEC/EN 60204-1.</p>	<p>Safe speed monitor (SSM)</p> <p>The SSM signals are outputted when the speed of the servo motor is below the specified speed limit.</p>
<p>Safe stop 2 (SS2)</p> <p>Responding to the input signal from external equipment, the servo motor starts to decelerate. After the set delay time for motor stop is passed, the SOS function starts. Monitoring the servo motor deceleration based on the motor deceleration rate is also supported. This function corresponds to the Stop category 2 of IEC/EN 60204-1.</p>	<p>Safe direction (SDI)</p> <p>This function monitors whether the servo motor moves in the command direction. If the servo motor moves in a different direction from the command direction, the STO function is executed.</p>
<p>Safe operating stop (SOS)</p> <p>This function monitors the position of the servo motor not to deviate from the specified range. Power is still supplied to the servo motor during the SOS function.</p>	<p>Safely-limited increment (SLI)</p> <p>This function monitors the travel distance of the servo motor not to deviate from the specified range. If the travel distance exceeds the range, the STO function is executed.</p>
<p>Safe brake control (SBC)</p> <p>The SBC signals are outputted for external brake control.</p>	<p>Safely-limited torque (SLT)</p> <p>This function monitors the torque (or the thrust) of the servo motor not to deviate from the specified range. If the torque (or the thrust) exceeds the range, the STO function is executed.</p>

: Function activation area

An engineering environment that provides common, consistent usability throughout all product development phases

Programmable Controller Engineering Software

MELSOFT GX Works3

Program creation is largely dependent on the ability of the programmer; therefore, an enormous amount of time is often spent on creating a servo program where a high level of programming expertise is required.

"MELSOFT GX Works3" introduces a more intuitive, efficient, and user-friendly programming environment that revolutionizes the programming process and minimizes hassles.

Engineering Environment for Maximizing Your Machine Performance

- Mitsubishi Electric offers a complete, consistent engineering environment which covers all aspects of the product development cycle - from sizing motors all the way to programming with function blocks, startup, and maintenance.

System Design

Programming

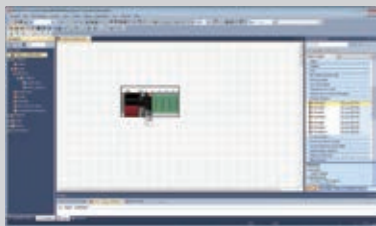

System configuration



Network configuration



Programming



e-Manual

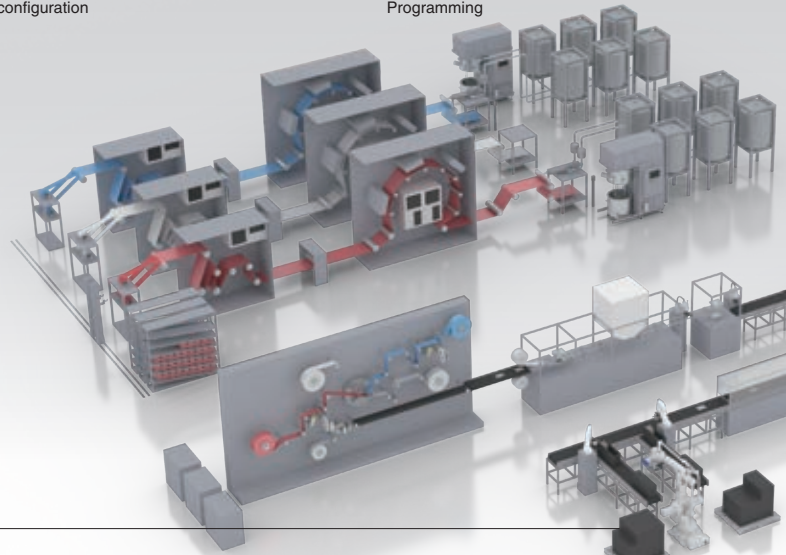

Useful Servo Software

[Drive system sizing software: "Motorizer"]

Our upgraded motor sizing software enables you to more flexibly select a suitable servo system for your machine. The upgraded features include expansion of selectable load mechanisms (13 types), multiple sizing results, and the ability to size a multi-axis system.



Motor sizing software



Model selection software

[Model selection software]

Servo amplifiers, servo motors, and indispensable options such as encoder cables can all be selected.

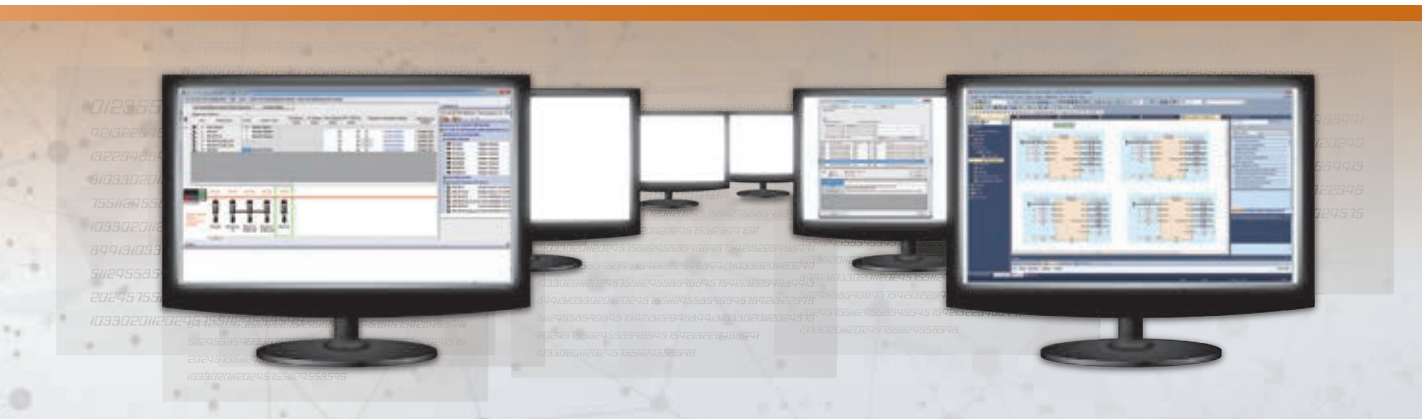

- All-in-one engineering platform MELSOFT GX Works3 allows you to set different modules in a single project, including the setting of a wide range of areas from servo amplifier parameters to PLC CPU data.

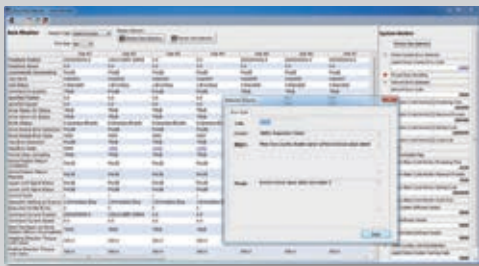

Monitor

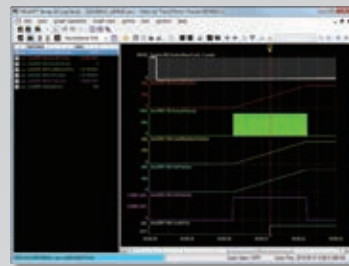

Real-time monitor



Servo adjustment^{*1}

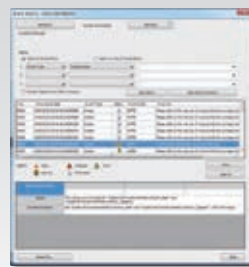

Event history

^{*1}. The servo adjustment is enabled via MR Configurator2.

Globalization

[PLCopen® Motion Control FB]

PLCopen® Motion Control FB is a standardized interface, and therefore people other than the program designer can understand the programming, leading to reduced design and maintenance time.



[Conforms to IEC 61131-3]

MELSOFT GX Works3 realizes structured programming such as ladder and ST, making project standardization across multiple users even easier.

[Multi-language support for global operations]

To adhere to today's global production needs, MELSOFT GX Works3 supports multi-language features at various levels, from the multiple language software menu system to device comment language switching features.

Supported languages: English, Japanese, and Chinese.

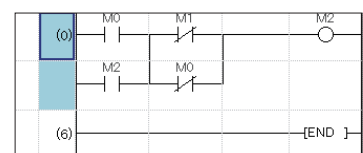

Easy programming

Faster, Simpler, Intuitive Programming with MELSOFT GX Works3

The software supports the internationally standardized PLCopen® Motion Control Function Blocks for motion control programming, and provides three selectable programming languages: ladder diagram (Ladder), function block diagram/ladder diagram (FBD/LD), and structured text language (ST). Select the programming method that suits your system scale, the application, and the required functions.

Programming

MELSOFT GX Works3 includes various user-friendly features - including intuitive operation with graphical setting screens, labels, and function blocks. These features greatly help users create a program faster and simpler.

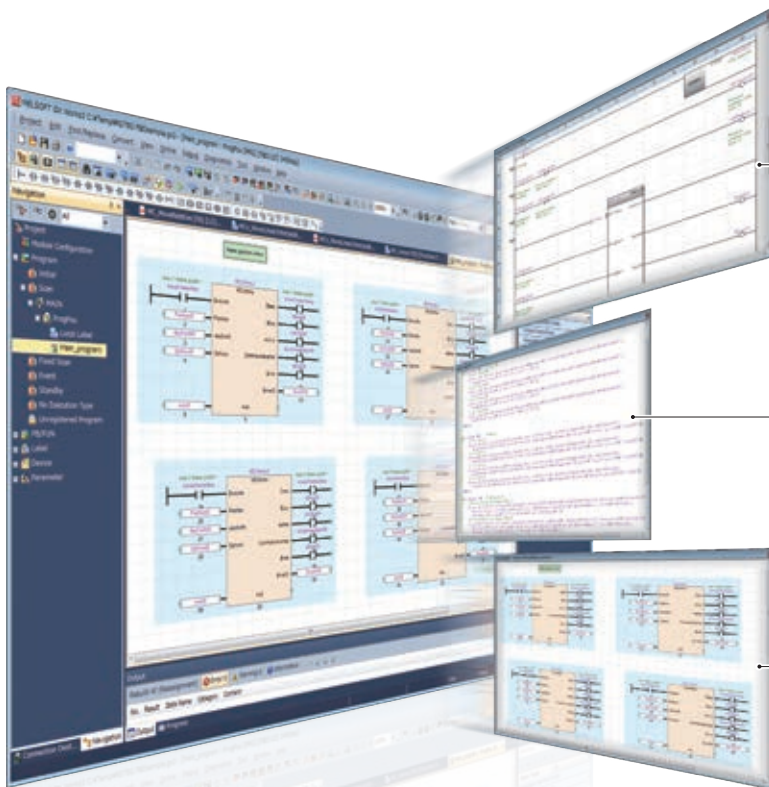
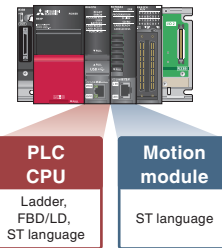

● Ladder diagram

Ladder diagram is a programming language used to describe sequence control. Each ladder consists of contacts and coils and represents logical operations consisting of AND/OR in combinations of series and parallel.

● Structured text language

ST language is defined by International Standard IEC61131-3 that defines the logic description system.

● FBD/LD

In FBD/LD programs, data flows from the output point of a function block, function, variable (label or device), or constant to the input point of another function block or variable.

Programming Using Function Blocks

The software offers a wide selection of function blocks - PLCopen® Motion Control Function Blocks and Mitsubishi Electric's original function blocks. You can easily create a program just by choosing the function blocks that your system requires.

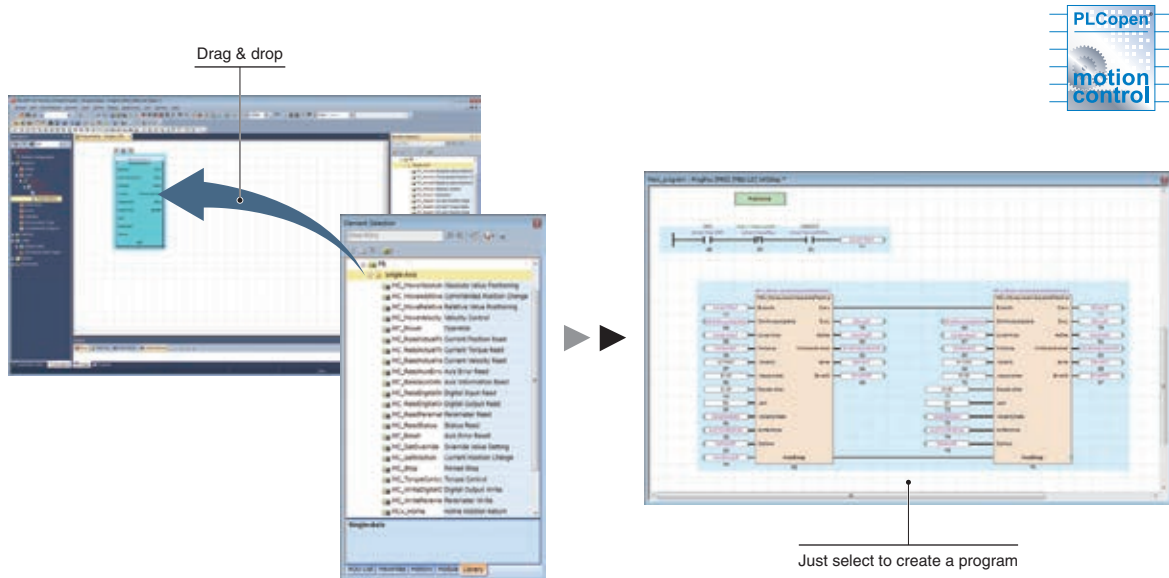

Easy Programming Through Structured Text Language

Create a structured text program just by dragging and dropping function blocks.

- Easy programming through drag & drop of programming elements
- Consistent usability for more intuitive operation
- A wide selection of programming elements in the library, helping to reduce programming time
- MELSOFT GX Works3 conforms to IEC 61131-3 and realizes structured programming such as ladder and ST, making project standardization across multiple users even easier.

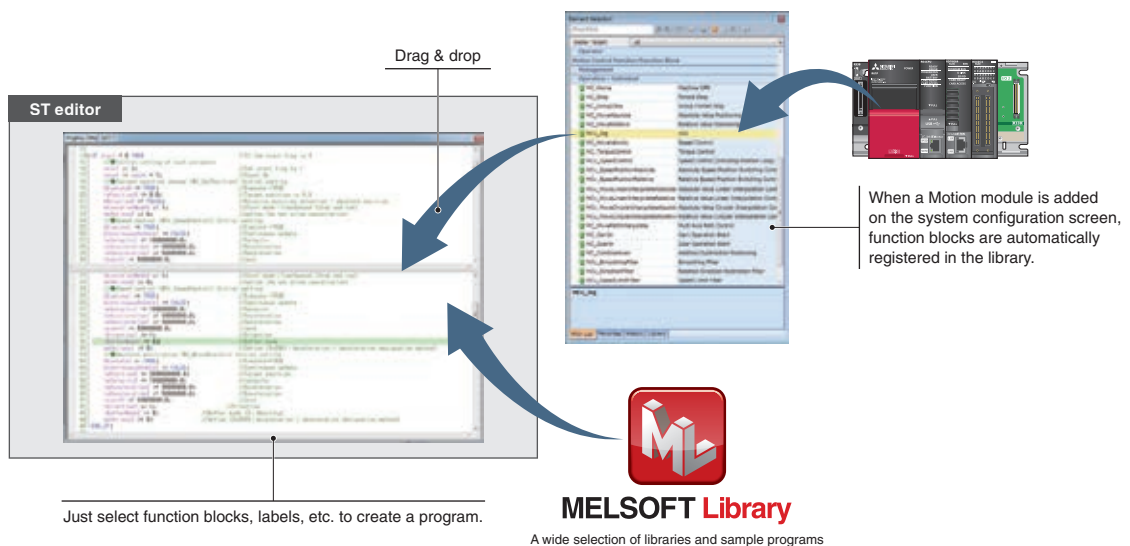

Innovate Together

CONTROLLER

Programmable Controllers



MELSEC iQ-R

CC-Link IE TSN-Compatible Motion Modules

NEW



RD78G



RD78GH

CC-Link IE TSN-Compatible Motion Control Software

Available soon



SWM78

INTERFACE

CC-Link IE TSN



SERVO AMPLIFIER

CC-Link IE TSN-Compatible Servo Amplifiers



MR-J5-G

CC-Link IE TSN-Compatible 2-Axis Servo Amplifiers



MR-J5W2-G

CC-Link IE TSN-Compatible 3-Axis Servo Amplifiers



MR-J5W3-G

*MR-J5-G-N1/MR-J5W2-G-N1/MR-J5W3-G-N1 servo amplifiers are compatible with EtherCAT®.

SERVO MOTOR

Rotary Servo Motors



Small capacity, low inertia
HK-KT Series
Capacity: 0.05 to 2 kW



Medium capacity, medium inertia
HK-ST Series
Capacity: 0.5 to 7 kW

SOLUTION



We take full advantage of Mitsubishi Electric's technological capability that achieved development of FA devices, along with our connectivity technology which makes it possible to connect FA with IT.

e-F@ctory optimizes manufacturing overall by connecting all devices and equipment, and then analyzing and utilizing the vast amount of data collected.

Create new value with MELSERVO-J5.
Unlock performance with a total drive solution

Programmable Controllers

MELSEC iQ-R MELSEC-Q MELSEC-L MELSEC iQ-F MELSEC-F

Graphic Operation Terminals

GOT2000

SOFTWARE



- MELSOFT GX Works3
- MELSOFT EM78 SDK Available soon
- MELSOFT MR Configurator2
- Drive System Sizing Software Motorizer

Positioning Modules

RD75P QD75PN LD75P FX5-20PG-P FX3U-1PG

RD75D QD75DN LD75D FX5-20PG-D

LOW-VOLTAGE SWITCHGEAR

Molded-Case Circuit Breakers	Magnetic Contactors
 WS-V	 MS-T

Pulse Train/ Analog Voltage

General Purpose Interface-Compatible Servo Amplifiers





MR-J5-A

OPTION



Simple Converters

MR-CM

Linear Servo Motors

 Core type LM-H3 Series Rating: 70 to 960 N	 Core type NEW LM-AJ Series Rating: 68.1 to 446.8 N	 Core type (natural/liquid cooling) LM-F Series Rating: 300 to 1200 N (natural cooling) Rating: 600 to 2400 N (liquid cooling)
 Core type with magnetic attraction counter-force LM-K2 Series Rating: 120 to 2400 N	 Coreless type LM-U2 Series Rating: 50 to 800 N	

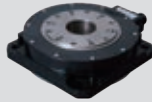
Direct Drive Motors



 Low-profile flange type TM-RG2M Series Rating: 2.2 to 9 N·m	 Low-profile table type TM-RU2M Series Rating: 2.2 to 9 N·m	 High-rigidity TM-RFM Series Rating: 2 to 240 N·m
--	--	--



Through powerful alliances between Mitsubishi Electric, who boasts a broad-ranging product appeal in the FA domain, and partners that participate in the FA partnership program (e-F@ctory Alliance) promoted by Mitsubishi Electric, we will achieve new business creation and new monozukuri.

Product Lines





■ Servo System Controllers

Servo system controller		Number of control axes	Slots occupied	Features
Motion modules	 RD78G	1 to 4 1 to 8 1 to 16 1 to 32 1 to 64	1	MELSEC iQ-R series CC-Link IE TSN-compatible Motion module <ul style="list-style-type: none"> Performs motion control (positioning, synchronous, cam, speed, and torque control) Maximum number of connectable stations: 120 stations ^(Note 2) Minimum operation cycle: 62.5 [μs]
	 RD78GH NEW	1 to 128 1 to 256	2	MELSEC iQ-R series CC-Link IE TSN-compatible Motion module <ul style="list-style-type: none"> Performs motion control (positioning, synchronous, cam, speed, and torque control) Maximum number of connectable stations: 120 stations ^(Note 2) Minimum operation cycle: 31.25 [μs]
Motion Control Software	 SWM78 Available soon	1 to 16 1 to 32 1 to 64 1 to 128 1 to 256	–	CC-Link IE TSN-compatible Motion Control Software ^(Note 1) <ul style="list-style-type: none"> Performs motion control (positioning, synchronous, cam, speed, and torque control) Supports INtime (real-time operating system) for Windows® Programming in Visual C++® Maximum number of connectable stations: 120 stations ^(Note 2)

Notes: 1. An industrial personal computer, INtime, and Visual Studio® are not included and must be prepared by the user.
2. Multi-axis servo amplifiers MR-J5W2-G/MR-J5W3-G occupy one station.

■ Servo Amplifiers

●: Supported ○: Future support planned –: Not supported

Servo amplifiers	Number of control axes	Power supply specifications ^(Note 2)	Rated output [kW] ^(Note 1)	Command interface			Control mode			Compatible servo motor series											
				CC-Link IE TSN	EtherCAT® ^(Note 3)	Pulse train	Analog voltage	Position	Velocity/Speed	Torque	Fully closed loop control	HK-KT	HK-ST	LM-H3	LM-AJ	LM-F	LM-K2	LM-U2	TM-RG2M	TM-RU2M	TM-FRM
 MR-J5-G	1 axis	200 V AC	0.1, 0.2, 0.4, 0.6, 0.75, 1, 2, 3.5, 5, 7	●	●	–	–	●	●	●	●	●	●	●	●	●	●	●	●	●	●
		400 V AC	0.6, 1, 2, 3.5, 5, 7	○	○	–	–	○	○	○	○	○	○	○	○	○	○	○	○	○	○
	 MR-J5W2-G	2 axes	200 V AC	0.2, 0.4, 0.75, 1	●	●	–	–	●	●	●	●	●	●	●	●	●	●	●	●	●
 MR-J5W3-G	3 axes	200 V AC	0.2, 0.4	●	●	–	–	●	●	●	–	●	●	●	●	●	●	●	●	●	●
 MR-J5-A	1 axis	200 V AC	0.1, 0.2, 0.4, 0.6, 0.75, 1, 2, 3.5, 5, 7	–	–	●	●	●	●	●	●	●	●	●	●	●	●	●	●	●	●
		400 V AC	0.6, 1, 2, 3.5, 5, 7	–	–	○	○	○	○	○	○	○	○	○	○	○	○	○	○	○	○

Notes: 1. The value listed is the servo amplifier rated output.
2. 200 V AC servo amplifiers are compatible with DC power supply input as standard.
3. EtherCAT® is supported by MR-J5-G-N1/MR-J5W2-G-N1/MR-J5W3-G-N1 servo amplifiers.

■ Options

Converters	Connectable servo amplifiers	Power supply specifications	Capacity [kW]	Features
 MR-CM Simple converter	1 to 6 units	200 V AC	3	MR-CM supports multi-axis systems and enables the following: <ul style="list-style-type: none"> boosting energy efficiency by using regenerative energy effectively reducing the number of molded-case circuit breakers and magnetic contactors to be used simplifying wiring reducing installation space

■ Rotary Servo Motors

●: Supported

Rotary servo motor series	Rated speed (maximum speed) [r/min] (Note 2)	Rated output [kW] (Note 1)	Servo motor type (Note 4)		IP rating (Note 3)	Replaceable series	Features	Application examples
			With an electro-magnetic brake (B)	With a gear reducer (G1, G5, G7)				
Small capacity	 3000 (6700)	0.05, 0.1, 0.15, 0.2, 0.4, 0.6, 0.75, 1.0, 1.5, 2.0 0.4, 0.6, 0.75, 1.0, 1.5, 2.0	●	●	IP67	HG-KR	Low inertia Batteryless absolute position encoder Product line includes flat type Connects using single connector	Belt drives Robots Mounters X-Y tables Semiconductor manufacturing systems Battery manufacturing systems





Notes: 1. : For 400 V, 400 V servo amplifiers are planned for a future release.

2. The speed varies by the model type.

3. The shaft-through portion is excluded. For geared servo motors, IP rating of the reducer part is equivalent to IP44.

4. G1 indicates a gear reducer for general industrial machines, and G5 and G7 indicate a gear reducer for high precision applications. Servo motors with a gear reducer are available only for 200 V, and the product lines are different.

■ Linear Servo Motors

Linear servo motor series	Maximum speed [m/s]	Continuous thrust [N]	Maximum thrust [N]	Cooling method	Features	Application examples	
 LM-H3 series	3.0	70, 120, 240, 360, 480, 720, 960	175, 300, 600, 900, 1200, 1800, 2400	Natural cooling	Suitable for space-saving. Compact size and high thrust. Maximum speed: 3 m/s.	Mounters Wafer cleaning systems FPD assembly machines Material handlings	
Core type	 LM-AJ series NEW	2.0 to 6.5	68.1, 117.0, 136.2, 174.5, 223.4, 234.0, 348.9, 446.8	214.7, 369.0, 429.4, 550.2, 704.5, 738.1, 1100.4, 1409.1	Natural cooling	Low installation height, and suitable for compact X-Y tables.	Semiconductor manufacturing systems FPD assembly machines
	 LM-K2 series	2.0	120, 240, 360, 720, 1200, 1440, 2400	300, 600, 900, 1800, 3000, 3600, 6000	Natural cooling	High thrust density. Magnetic attraction counter-force structure enables longer life of the linear guides and lower audible noise.	Mounters Wafer cleaning systems FPD assembly machines
Coreless type	 LM-U2 series	2.0	50, 75, 100, 150, 225, 400, 600, 800	150, 225, 300, 450, 675, 1600, 2400, 3200	Natural cooling	High thrust density. Magnetic attraction counter-force structure enables longer life of the linear guides and lower audible noise.	Screen printing systems Scanning exposure systems Inspection systems Material handlings

■ Direct Drive Motors

Direct drive motor series	Motor outer diameter [mm]	Hollow shaft diameter [mm]	Rated speed [r/min]	Maximum speed [r/min]	Rated torque [N·m]	Maximum torque [N·m]	IP rating (Note 1)	Features	Application examples	
Low-profile	 TM-RG2M/TM-RU2M series	ø130	ø20	300	600	2.2	8.8	IP40	Suitable for low-speed and high-torque operations. Smooth operation with less audible noise. The motor's low profile design contributes to compact construction and a low center of gravity for enhanced machine stability. Clean room compatible.	Semiconductor manufacturing devices Liquid crystal manufacturing devices Machine tools
		ø180	ø47	300	600	4.5	13.5	IP40		
		ø230	ø62	300	600	9	27	IP40		
High-rigidity	 TM-RFM series	ø130	ø20	200	500	2, 4, 6	6, 12, 18	IP42		
		ø180	ø47	200	500	6, 12, 18	18, 36, 54	IP42		
		ø230	ø62	200	500	12, 48, 72	36, 144, 216	IP42		
		ø330	ø104	100	200	40, 120, 240	120, 360, 720	IP42		

Notes: 1. Connectors and the gap along the rotor (output shaft) are excluded.

Mitsubishi Electric Solutions

e-F@ctory

Maximize productivity and reduce costs with an intelligent smart factory solution

Intelligent smart factories utilize high-speed networks with large data bandwidths to meet current manufacturing needs. The combination of CC-Link IE TSN and Mitsubishi Electric's e-F@ctory solution ensures robust integration between IT and factory automation systems, providing an intelligent smart factory solution that reduces total cost while improving operations, production yield, and efficient management of the supply chain. e-F@ctory is the Mitsubishi Electric solution for adding value across the manufacturing enterprise by enhancing productivity, thereby simultaneously reducing maintenance and operating costs, and enabling the seamless flow of information throughout the plant. e-F@ctory uses a combination of factory automation and IT technologies in combination with various best-in-class partner products through its alliance program.

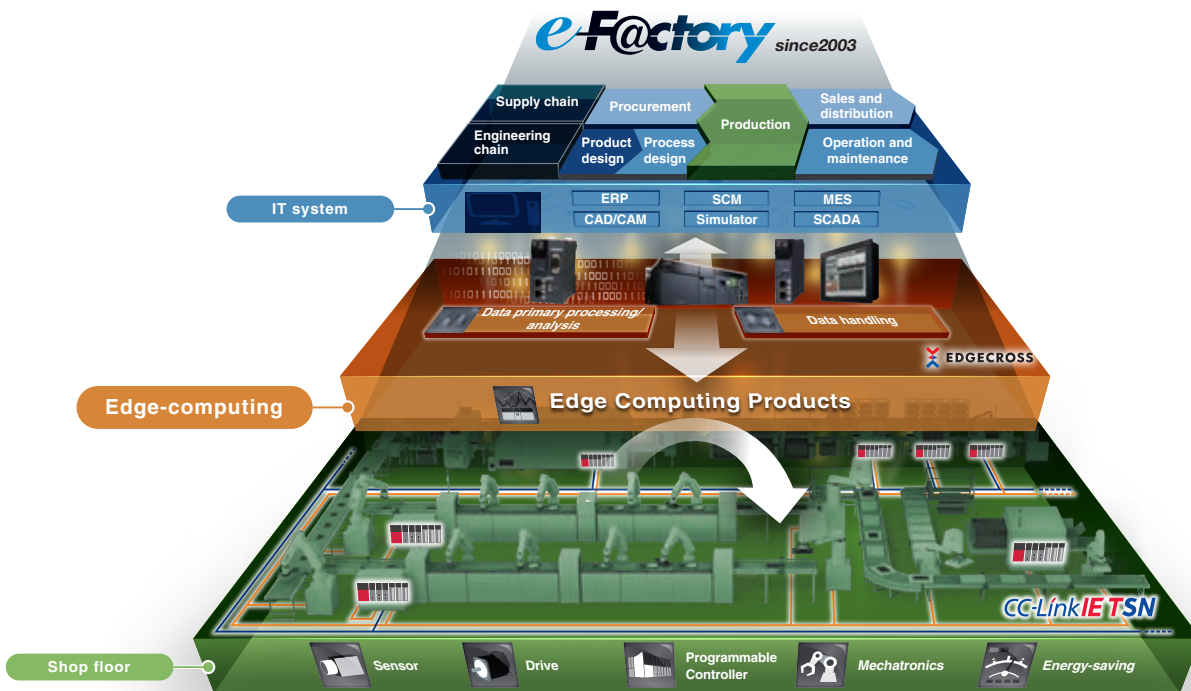

CC-Link IE TSN

- IT integration
- Open technology

- High speed, Time synchronization
- Network integration

MELSEC iQ-R
GOT2000

MELSEC iQ-F

MITSUBISHI ELECTRIC SYNO SYSTEM
MELSER I/O-15
MELFA FR

FREQROL-A800/E800
MITSUBISHIELECTRIC
CNC C80

SMART FACTORY

Productivity

Quality

Flexibility

Maintenance

Mitsubishi Electric Partners

e-F@ctory Alliance

The e-F@ctory Alliance is a FA manufacturer partnering program that strongly links the connection compatibility of Mitsubishi Electric FA equipment utilizing excellent software and machinery offered by partners, thereby enabling systems to be built by systems integration partners and the proposal of optimal solutions to customers.



Mitsubishi Electric Servo System Partners

Servo system includes controllers, servo drivers, actuators, sensors, etc. The servo system takes a step further to accelerate the equipment revolution by collaborating with our partner companies. Now that a wide variety of partner products are available such as stepping motors, pressure-resistance, explosion-proof type motors, linear encoders, your system will be configured flexibly. The Mitsubishi Electric Servo System Partner Association is a subcommittee of e-F@ctory Alliance. Partner product lines supporting CC-Link IE TSN and MELSERVO-J5 have been and will continue to be expanded sequentially.



Android and Google Play are trademarks of Google Inc.
 Apple, iPad, iPad Air, iPad mini, and App Store are trademarks of Apple Inc., registered in the U.S. and other countries.
 Microsoft, Windows, Visual C++, and Visual Studio are either registered trademarks or trademarks of Microsoft Corporation in the United States and/or other countries.
 Celeron and Pentium are either registered trademarks or trademarks of Intel Corporation in the United States and/or other countries.
 Ethernet is a registered trademark of Fuji Xerox Co., Ltd. in Japan.
 PLCopen and related logos are registered trademarks of PLCopen.
 EtherCAT is a registered trademark and patented technology, licensed by Beckhoff Automation GmbH, Germany.
 All other company names and product names used in this document are trademarks or registered trademarks of their respective companies.

Mitsubishi Electric FA Global Website

Mitsubishi Electric Factory Automation provides a mix of services to support its customers worldwide, through a consolidated global website. It offers a selection of support tools and a window to its local Mitsubishi Electric sales and support network.

Global & Local Websites

Mitsubishi Electric Factory Automation
Global website
www.MitsubishiElectric.com/fa

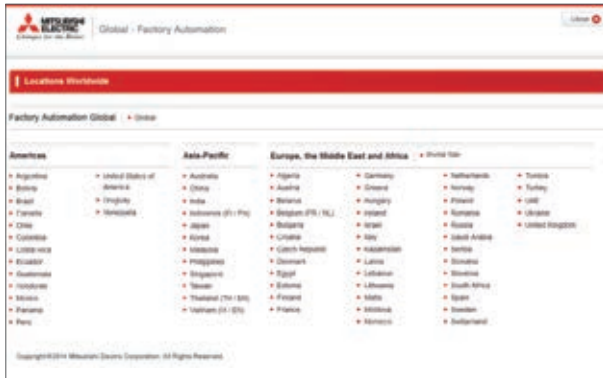

Local websites



Global website

e-Manuals

Instruction manuals are available in e-Manual format.

- Use the e-Manual application on tablets
- Download and update manuals quickly and easily
- Search for desired information across multiple manuals



Model Selection Software

Model selection software is now available, so you can select options such as encoder cables and power cables which are required to use with controllers, servo motors, servo amplifiers, and regenerative options of your choice. The result can be saved in a CSV format and can be used as a purchase list.

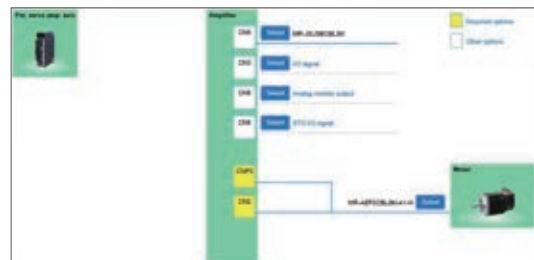

Model selection software

CC-Link Partner Association (CLPA) - Actively promoting worldwide adoption of CC-Link networks

Proactively supporting CC-Link, from promotion to specification development

The CC-Link Partner Association (CLPA) was established to promote the worldwide adoption of the CC-Link open-field network. By conducting promotional activities such as organizing trade shows and seminars, conducting conformance tests, and providing catalogs, brochures and website information, CLPA activities are successfully increasing the number of CC-Link partner manufacturers and CC-Link-compatible products. As such, CLPA is playing a major role in the globalization of CC-Link.



Seminar

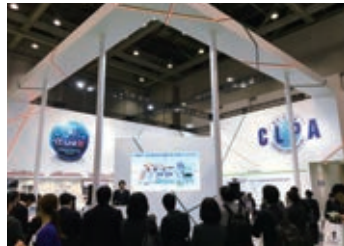

Trade show



Conformance testing lab

Visit the CLPA website for the latest CC-Link information.

URL: www.cc-link.org



CLPA Headquarters
 6F Ozone Front Bldg. 3-15-58 Ozone
 Kita-ku, Nagoya 462-0825, JAPAN
 TEL: +81-52-919-1588 FAX: +81-52-916-8655
 E-mail: info@cc-link.org



Global influence of CC-Link continues to spread

CC-Link is supported globally by CLPA. With offices throughout the world, support for partner companies can be found locally. Each regional CLPA office undertakes various support and promotional activities to further the influence of CC-Link/CC-Link IE in that part of the world. For companies looking to increase their presence in their local area, CLPA is well placed to assist these efforts through offices in all major regions.

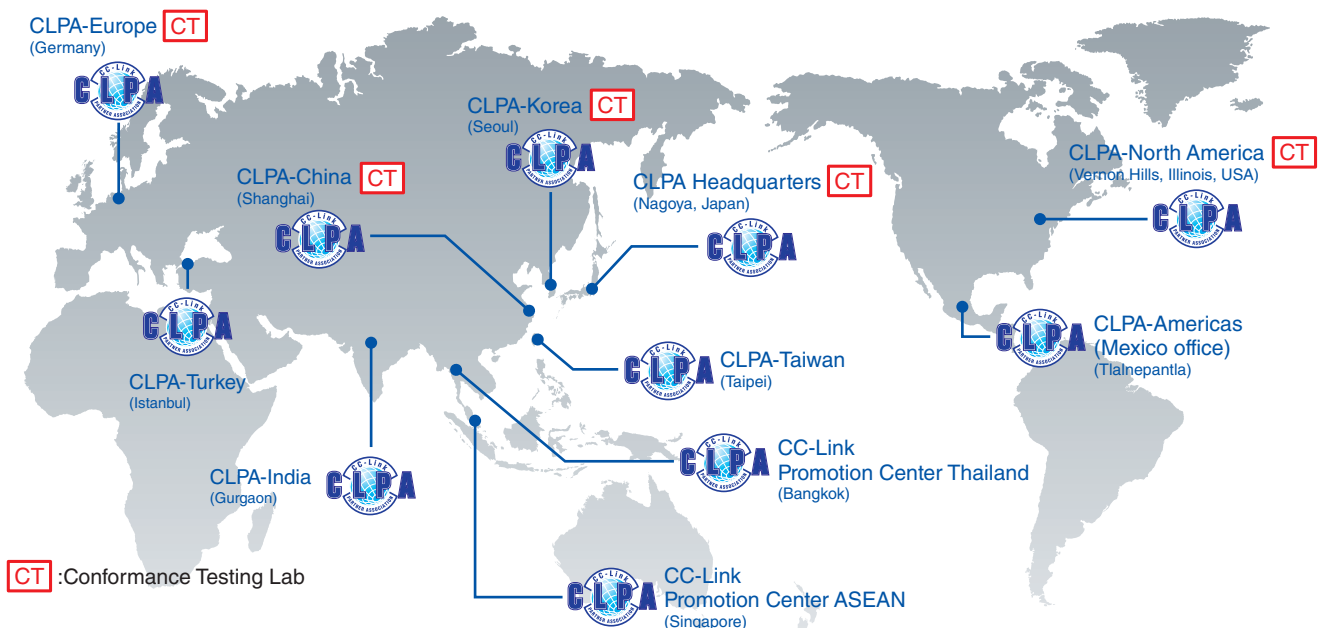

Mitsubishi Electric AC Servo System MELSERVO-J5

Country/Region	Sales office	Tel
USA	Mitsubishi Electric Automation, Inc. 500 Corporate Woods Parkway, Vernon Hills, IL 60061, U.S.A.	Tel : +1-847-478-2100
Mexico	Mitsubishi Electric Automation, Inc. Mexico Branch Boulevard Miguel de Cervantes Saavedra 301, Torre Norte Piso 5, Ampliacion Granada, Miguel Hidalgo, Ciudad de Mexico, Mexico, C.P.11520	Tel : +52-55-3067-7512
Brazil	Mitsubishi Electric do Brasil Comercio e Servicos Ltda. Avenida Adelino Cardana, 293, 21 andar, Bethaville, Barueri SP, Brazil	Tel : +55-11-4689-3000
Germany	Mitsubishi Electric Europe B.V. German Branch Mitsubishi-Electric-Platz 1, 40882 Ratingen, Germany	Tel : +49-2102-486-0
UK	Mitsubishi Electric Europe B.V. UK Branch Travellers Lane, UK-Hatfield, Hertfordshire, AL10 8XB, U.K.	Tel : +44-1707-28-8780
Italy	Mitsubishi Electric Europe B.V. Italian Branch Centro Direzionale Colleoni - Palazzo Sirio, Viale Colleoni 7, 20864 Agrate Brianza (MB), Italy	Tel : +39-039-60531
Spain	Mitsubishi Electric Europe B.V. Spanish Branch Carretera de Rubi, 76-80-Apdo. 420, E-08190 Sant Cugat del Valles (Barcelona), Spain	Tel : +34-935-65-3131
France	Mitsubishi Electric Europe B.V. French Branch 25, Boulevard des Bouvets, 92741 Nanterre Cedex, France	Tel : +33-1-55-68-55-68
Czech Republic	Mitsubishi Electric Europe B.V. Czech Branch, Prague Office Pekarska 621/7, 155 00 Praha 5, Czech Republic	Tel : +420-255-719-200
Poland	Mitsubishi Electric Europe B.V. Polish Branch ul. Krakowska 48, 32-083 Balice, Poland	Tel : +48-12-347-65-00
Russia	Mitsubishi Electric (Russia) LLC St. Petersburg Branch Piskarevsky pr. 2, bld 2, lit "Sch", BC "Benua", office 720; 195027 St. Petersburg, Russia	Tel : +7-812-633-3497
Sweden	Mitsubishi Electric Europe B.V. (Scandinavia) Hedvig Mollersgata 6, 223 55 Lund, Sweden	Tel : +46-8-625-10-00
Turkey	Mitsubishi Electric Turkey A.S. Umraniye Branch Serifali Mahallesi Nutuk Sokak No:5, TR-34775 Umraniye / Istanbul, Turkey	Tel : +90-216-526-3990
UAE	Mitsubishi Electric Europe B.V. Dubai Branch Dubai Silicon Oasis, P.O.BOX 341241, Dubai, U.A.E.	Tel : +971-4-3724716
South Africa	Adroit Technologies 20 Waterford Office Park, 189 Witkoppen Road, Fourways, South Africa	Tel : +27-11-658-8100
China	Mitsubishi Electric Automation (China) Ltd. Mitsubishi Electric Automation Center, No.1386 Hongqiao Road, Shanghai, China	Tel : +86-21-2322-3030
Taiwan	SETSUYO ENTERPRISE CO., LTD. 6F, No.105, Wugong 3rd Road, Wugu District, New Taipei City 24889, Taiwan	Tel : +886-2-2299-2499
Korea	Mitsubishi Electric Automation Korea Co., Ltd. 7F to 9F, Gangseo Hangang Xi-tower A, 401, Yangcheon-ro, Gangseo-Gu, Seoul 07528, Korea	Tel : +82-2-3660-9529
Singapore	Mitsubishi Electric Asia Pte. Ltd. 307 Alexandra Road, Mitsubishi Electric Building, Singapore 159943	Tel : +65-6473-2308
Thailand	Mitsubishi Electric Factory Automation (Thailand) Co., Ltd. 101, True Digital Park Office, 5th Floor, Sukhumvit Road, Bangchak, Phra Khanong, Bangkok	Tel : +66-2092-8600
Indonesia	PT. Mitsubishi Electric Indonesia Gedung Jaya 8th Floor, JL. MH. Thamrin No.12, Jakarta Pusat 10340, Indonesia	Tel : +62-21-3192-6461
Vietnam	Mitsubishi Electric Vietnam Company Limited 11th & 12th Floor, Viettel Tower B, 285 Cach Mang Thang 8 Street, Ward 12, District 10, Ho Chi Minh City, Vietnam	Tel : +84-28-3910-5945
India	Mitsubishi Electric India Pvt. Ltd. Pune Branch Emerald House, EL-3, J Block, M.I.D.C., Bhosari, Pune - 411026, Maharashtra, India	Tel : +91-20-2710-2000
Australia	Mitsubishi Electric Australia Pty. Ltd. 348 Victoria Road, P.O. Box 11, Rydalmere, N.S.W 2116, Australia	Tel : +61-2-9684-7777

Mitsubishi Electric Corporation Nagoya Works is a factory certified for ISO14001 (standards for environmental management systems) and ISO9001 (standards for quality assurance management systems)

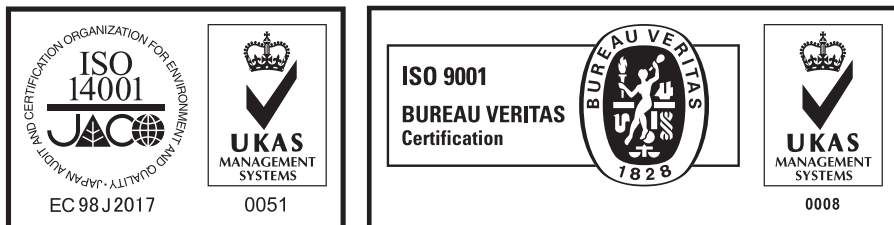

MITSUBISHI ELECTRIC CORPORATION

HEAD OFFICE: TOKYO BUILDING, 2-7-3, MARUNOUCHI, CHIYODA-KU, TOKYO 100-8310, JAPAN
NAGOYA WORKS: 1-14, YADA-MINAMI 5, HIGASHI-KU, NAGOYA, JAPAN