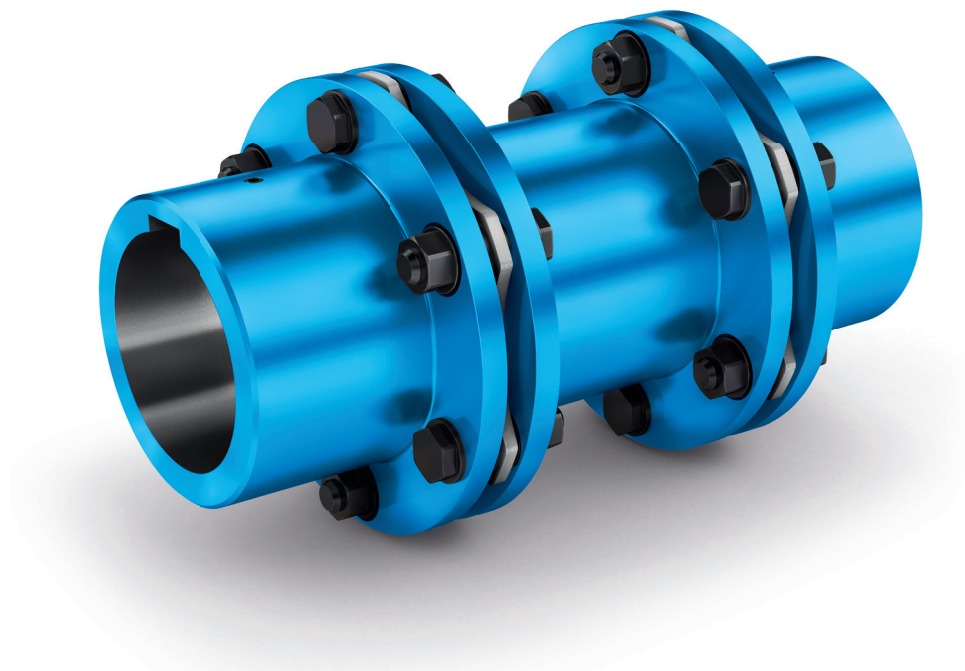


FLENDER COUPLINGS
CATALOG **MD 10.1N**
EDITION 2019 EN



N-ARPEX ALL-STEEL MULTIPLE-DISK COUPLINGS

RELATED CATALOGS

FLENDER Couplings

Standard Couplings
MD 10.1
PDMD-C10143-00



Gear units

Fast Track
MD 20.12
PDMD-C10156-00



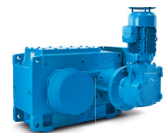
N-ARPEX

All-steel multiple-disk couplings
MD 10.1N
PDMD-C10144-01



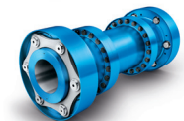
Bucket Elevator Drives

MD 20.2
PDMD-C10157-00



ARPEX

High Performance Couplings
MD 10.2
PDMD-C10146-00



PLANUREX 2

Planetary Gear Units
MD 20.3
PDMD-C10158-00



SIPEX and BIPEX-S

Backlash-free Couplings
MD 10.3
PDMD-C10145-00



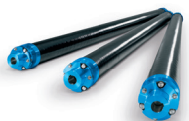
Paper Machine Drives

MD 20.5
PDMD-C10159-00



ARPEX

Composite Couplings
MD 10.5
PDMD-C10153-00



Conveyor Belt Drives

MD 20.6
PDMD-C10160-00



ARPEX

Torque Limiters
MD 10.11
PDMD-C10147-00



Marine Reduction Gearboxes

MD 20.7
PDMD-C10161-00



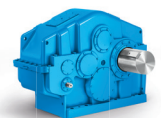
FLENDER SIP

Standard Industrial Planetary Gear Units-
MD 31.1
PDMD-C10154-00



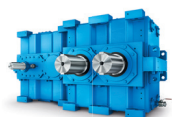
DUORED 2

Helical Gear Units, Load-sharing
MD 20.8
PDMD-C10162-00



FLENDER CHG

Helical Gear Units
MD 20.10
PDMD-C10155-00



Pinion Drive for Tube Mills

MD 20.9
PDMD-C10163-00



N-ARPEX



Catalog MD 10.1 N · 2019

General	6/2
Overview	6/2
Benefits	6/2
Application	6/2
Design	6/3
N-ARPEX configurations	6/4
Plate-pack designs	6/4
Plate pack screw connection	6/4
Technical data	6/5
Type NEN/NHN	6/6
Selection and ordering data	6/6
Type MCECM/MCHCM	6/8
Selection and ordering data	6/8
Type MFEFM/MFHFM	6/10
Selection and ordering data	6/10
Type BEB	6/12
Selection and ordering data	6/12
Other design options	6/13
Plate pack	6/14
Selection and ordering data	6/14
Clamping hub	6/16
Selection and ordering data	6/16
Dimensions and torques	6/18
Other data	6/19
Technical data	6/20
Bore specifications	6/23

The products and systems described in this catalog are manufactured/distributed under application of a certified quality management system in accordance with EN ISO 9001 (Certified Registration No. 01 100 000708). The certificate is recognized by all IQNet countries.





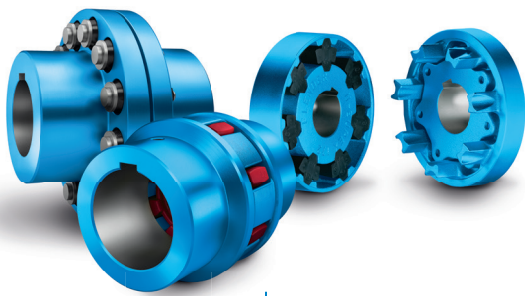
THE PERFECT COUPLING FOR EVERY REQUIREMENT

We provide elastic, highly elastic, rigid and hydrodynamic solutions.

Regardless of which demands are made on the coupling: Low or high performance, demanding operating conditions or high ambient temperatures, dusty or hazardous environments – we have the right portfolio. Our comprehensive range of couplings offers a large number of sizes and designs with a torque range from 0.5 to 7,200,000 Nm.

In over 90 years of development, conception and production, our product portfolio has grown to its current level of diversity. Nearly every matured coupling solution is available as a standard item in our modular system. This saves our customers time and money.

We are a powerful and flexible player in every market in the world – just like our customers. The production of our coupling components aims for maximum quality. As a trio, the setup, material and design result in optimal coupling solutions – rugged, dependable, largely low-maintenance and, above all, available at any time, anywhere. We provide high quality, first class delivery performance, and comprehensive service.



Flexible couplings

Our elastic couplings are pluggable and easy to install. The elastomer element equalizes the shaft offset and absorbs impacts from the motor or driven machine.

Nominal output torque: 12 Nm ... 1,300,000 Nm



Torsionally rigid couplings

Our compact steel couplings provide extremely precise transmission of high torques, especially in harsh operating conditions and extreme temperatures.

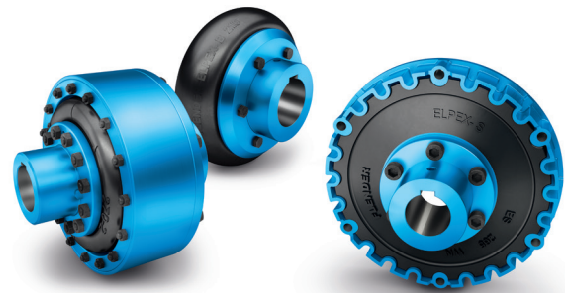
Nominal output torque: 92 Nm ... 7,200,000 Nm



Hydrodynamic couplings

Soft start, overload protection, torsional vibration damping – FLUDEX® fluid couplings allow the torque-limited approach and have very little slippage at rated load.

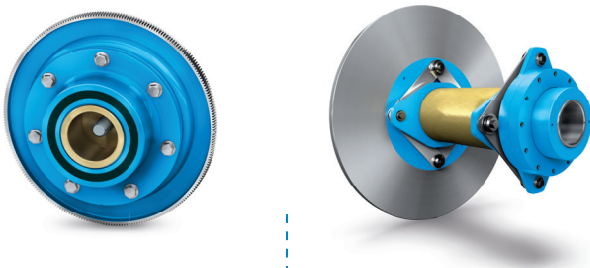
Power: 1.2 kW ... 2,500 kW



Highly-flexible couplings

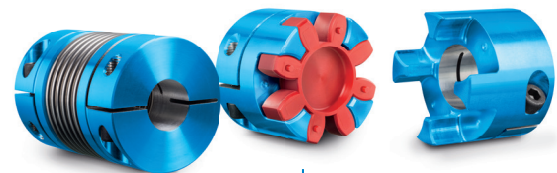
Highly flexible couplings are well-suited for connecting machines that operate with strongly non-uniform torque characteristics. They are preferred for use in systems that are periodically operated.

Nominal output torque: 24 Nm ... 90,000 Nm



Application-specific couplings

Flender offers a variety of application-specific couplings for rail vehicles and use in wind energy generation.



Backlash-free couplings

Our couplings act as a modular interface between the motor and the work machine to ensure reliable, backlash-free power transmission in servodrives and positioning drives.

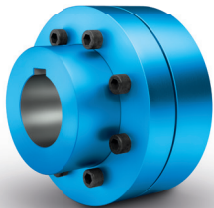
Nominal torque: 0.1 Nm ... 5,000 Nm

OUR COUPLING GROUPS AT A GLANCE

N-EUPEX, RUPEX and N-BIPEX

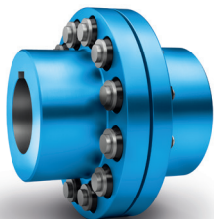
Flexible couplings

Flexible Flender couplings have a wide range of possible applications. A broad standard modular system as well as specially designed application-specific couplings are available.



N-EUPEX
cam couplings

Nominal output torque:
19 Nm ... 62,000 Nm



RUPEX
pin-and-bush couplings

Nominal output torque:
200 Nm ... 1,300,000 Nm



N-BIPEX
cam couplings

Nominal output torque:
12 Nm ... 4,650 Nm

ELPEX, ELPEX-B and ELPEX-S

Highly flexible couplings

ELPEX® couplings are free of circumferential backlash. Their damping capacity and low torsional stiffness make them especially well-suited for coupling machines with strongly non-uniform torque characteristics or large shaft misalignment.



ELPEX
elastic ring couplings

Nominal output torque:
1,600 Nm ... 90,000 Nm



ELPEX-B
elastic tire couplings

Nominal output torque:
24 Nm ... 14,500 Nm



ELPEX-S
rubber disk couplings

Nominal output torque:
330 Nm ... 63,000 Nm

ZAPEX gear couplings and ARPEX all-steel couplings Torsionally rigid couplings

For transmission of high torques, we offer both ARPEX all-steel couplings and ZAPEX gear couplings in a range of versions. Their purposes of application vary according to specific requirements with respect to shaft misalignment, temperature and torque.



ZAPEX
gear coupling

Nominal output torque:
1,300 Nm ... 7,200,000 Nm



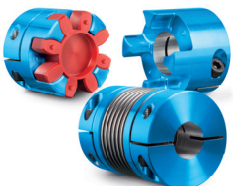
N-ARPEX and ARPEX
all-steel couplings

Nominal output torque:
92 Nm ... 2,000,000 Nm

BIPEX-S and SIPEX

Backlash-free couplings

The vibration-damping, electrically insulating plug-in BIPEX-S elastomer couplings and SIPEX metal bellows couplings with very high torsional stiffness deliver especially isogonal torque transmission.



BIPEX-S and SIPEX

Nominal torque:
0.1 Nm ... 5,000 Nm

FLUDEX

Hydrodynamic couplings

The FLUDEX hydrodynamic fluid coupling works according to the Föttinger principle. It functions entirely free of wear.

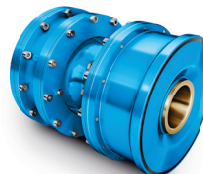


FLUDEX
fluid couplings

Power:
1.2 kW ... 2,500 kW

Application-specific couplings

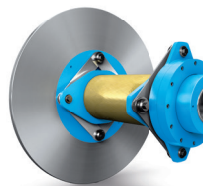
Couplings for rail vehicles must meet high demands. Due to their high degree of standardization and wide variety, they can be used in the most diverse vehicle types.



Railway coupling:

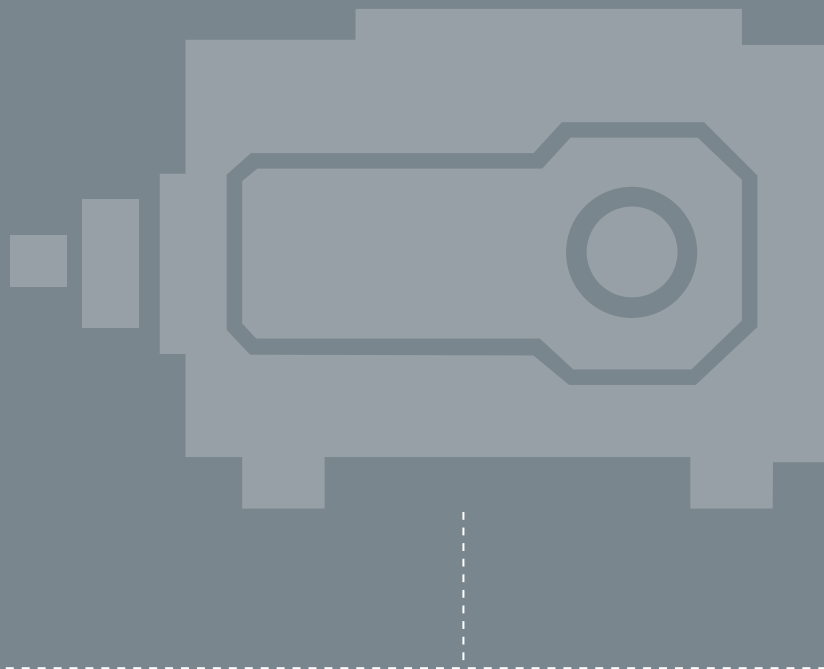
Nominal torque:
1,000 Nm ... 9,500 Nm

Each wind turbine coupling is designed to optimally meet the requirements of the respective wind turbine. The coupling connects the fast-running gear shaft with the generator shaft and is available for wind turbines with a capacity of up to 12 MW.



Wind turbine couplings

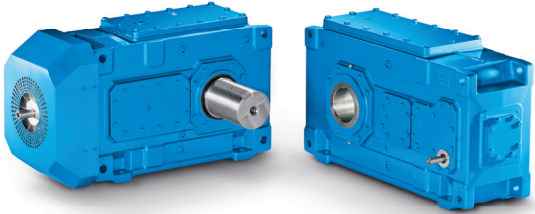
Nominal torque:
10,000 Nm ... 60,000 Nm



THE RIGHT GEAR UNIT SOLUTION FOR ANY REQUIREMENT

We provide helical and planetary gear units made up of standard modules or as a complete application solution.

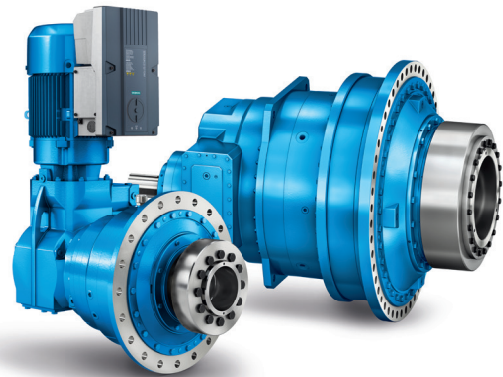
Helical and planetary gear units from Flender are modern drive solutions that satisfy the most varying and extreme demands, day after day and year after year. For decades, plant operators have been achieving high system reliability and low lifecycle costs in every conceivable industry with our helical gear units.



Helical and bevel helical gear units

Flender helical and bevel helical gear units are by far the most comprehensive range of industrial gear units in the world. It ranges from a multi-faceted universal gear unit portfolio and application-specific gear units to customer-specific solutions.

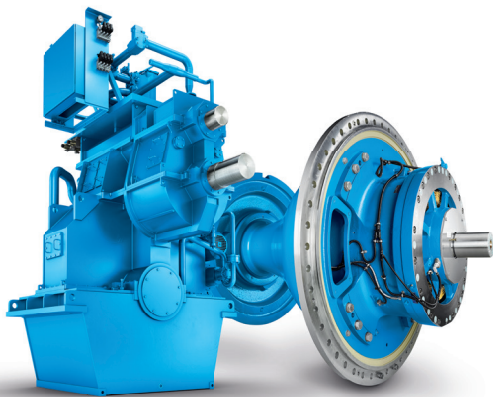
Nominal output torque: 3,300 Nm ... 1,400,000 Nm



Planetary gear units

With Flender planetary gear units, we provide a range of durable, reliable and finely graduated gear unit solutions. The series wins customers over due to its highly integrated planetary geared motor and maximum conformity with all international motor standards. It also brings quality and performance in a good ratio of lifecycle costs to price.

Nominal output torque: 10,000 Nm ... 5,450,000 Nm



Application-specific gear units

With application-specific gear units, Flender provides by far the most application solutions and thus covers nearly every drive-related need from hundreds of applications in industry and the acquisition of raw materials.

Nominal output torque: Up to 10,000,000 Nm



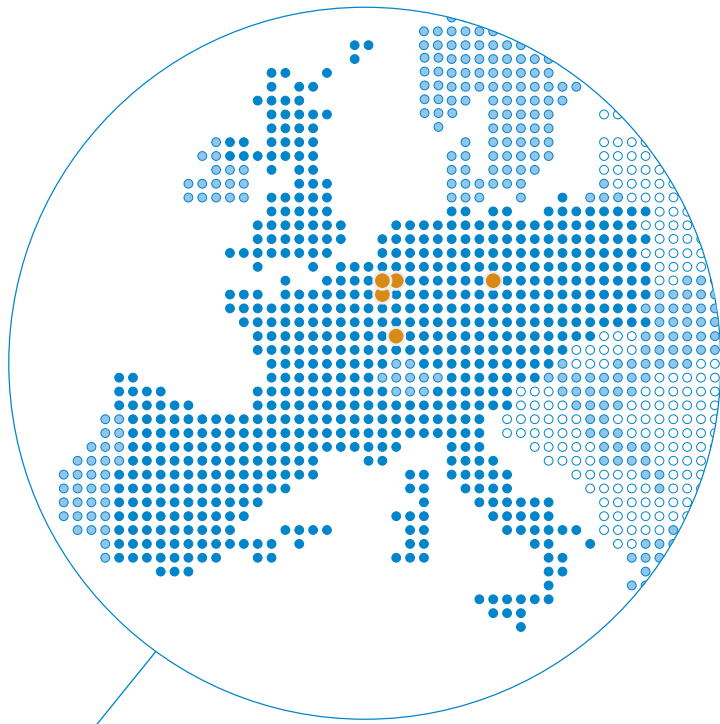
Customer-specific designs

Our experts are available at any time for special requirements during the development of new products. From designing and simulating complex drive solutions to implementing them, we work together with you to resolve multi-layered tasks.

BY YOUR SIDE.

Competency, flexibility and top performance on-site: With our setup, we can offer customer proximity worldwide. In addition to seven plants, we are broadly represented on five continents by sales and service locations. Thanks to our global setup, we have achieved a very high level of efficiency in production, installation, sales and service.





EUROPE

Germany



Bocholt



Voerde



Mussum

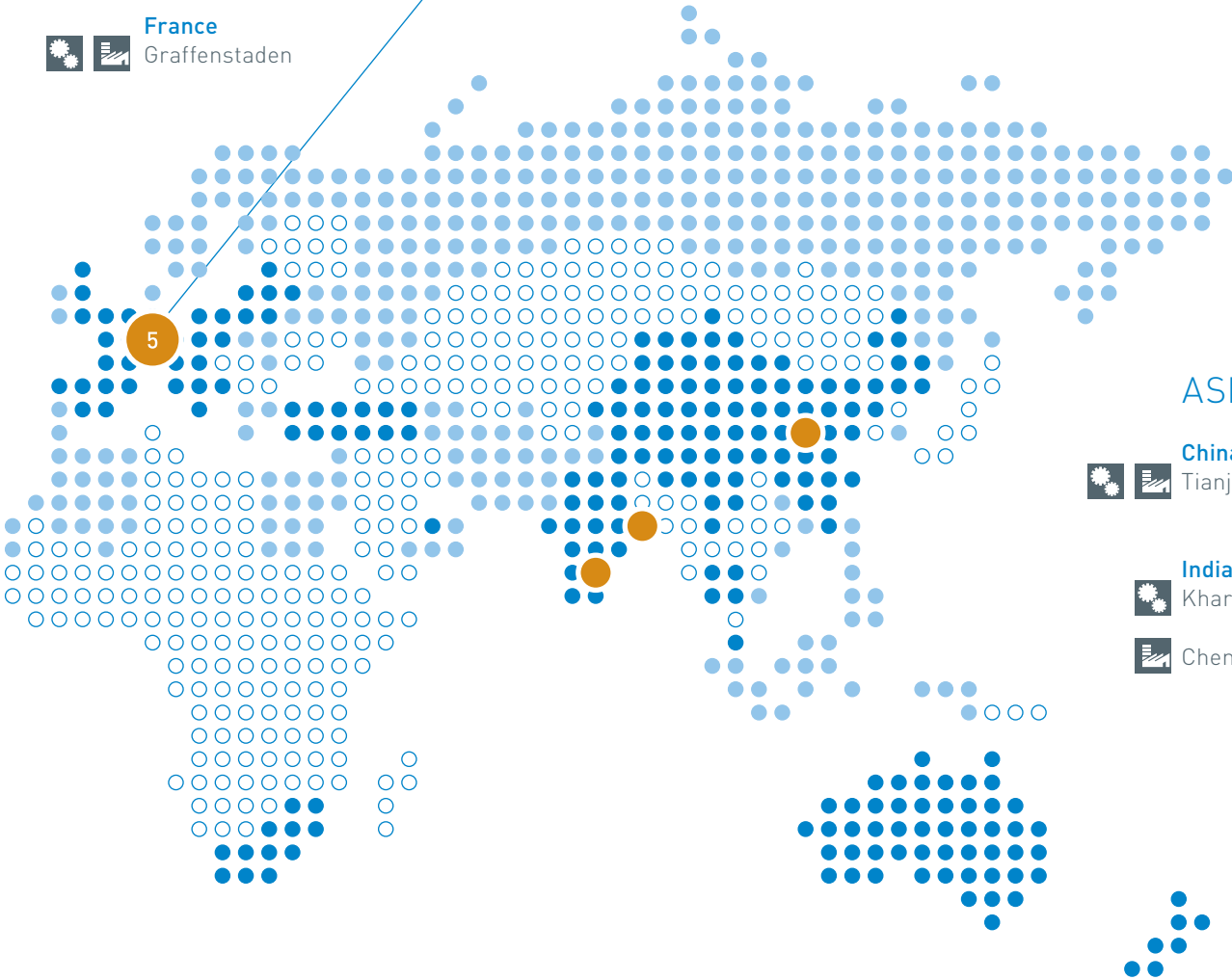


Penig



France

Graffenstaden



ASIA

China



Tianjin

India



Kharagpur



Chennai



Flender subsidiary



Sales and/or service partners



Manu-
facturing



Assembly

GENERAL

Overview



Couplings suitable for use in potentially explosive environments.

Comply with the present ATEX directive for:



II 2G Ex h IIC T6...T2 Gb X



II 2D Ex h IIIC T85°C...250°C Db X



I M2 Ex h Mb X

Benefits

The N-ARPEX coupling of the ARN-6/-8/-10 series stands out by its application-optimised design. The NEN, BEB, MCECM, MFEFM types satisfy the requirements of API 610. A coupling design in accordance with API 671 is also possible. For speeds of over 1,800 1/min the five-part version with pre-assembled intermediate unit is used.

Application

N-ARPEX couplings of the ARN-6/-8/-10 series are used wherever reliable torque transmission is called for, even in cases of often unavoidable shaft misalignment. They are universally applicable over a temperature range of from -50 °C (or even as low as -60 °C on request) up to +280 °C, are torsionally rigid, free of torsional backlash and enable quiet running at a constant angular velocity. They are wear-free and maintenance-free and, if correctly fitted, can be expected to have an unlimited service life.

Especially consideration is given to use in pump and compressor drives. Available for this are couplings with standardised intermediate spacer lengths from stock (see following tables).

Main areas of application for ARN-6/-8/-10 series:

- Pumps
- Fans
- Compressors
- Generator and turbine drives
- Axial and radial fans
- Paper and printing machinery
- Mixers, agitators
- Extruders
- Lifting and travelling gears
- Marine drives
- Water screw drives

By the launch of the new FLENDER N-ARPEX all-steel multiple-disk couplings Flender is continuing the success

A special catching device acts to secure the intermediate spacer in the event of plate breakage. Application of the N-ARPEX coupling in potentially explosive environments according to the requirements in the present **ATEX directive** is permissible.



story of the proven ARPEX coupling series.

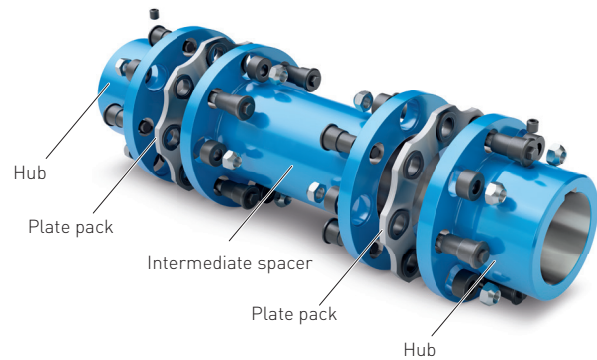
An optimised plate pack and a reworked component part design enable even higher torques and speeds to be transmitted.

In short, the new design of the plate packs, the closed flange geometry, the standard catching device of the intermediate spacer and FEM-optimised force distribution inside the all-steel multiple-disk coupling clearly show that the development has paid off.

Design

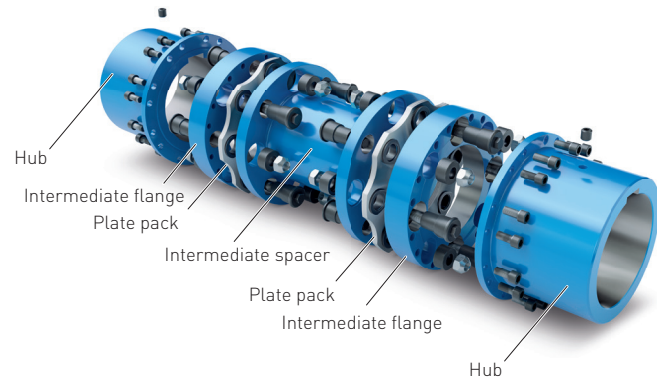
NEN

The design of an N-ARPEX type NEN is shown in the following illustration. The coupling comprises two hubs, an intermediate spacer and two plate packs that in the ARN-6 series are bolted together alternately with close-fitting bolts and in the ARN-8/-10 series by means of a Flender conical screw connection. The coupling is available in fixed lengths from stock. Other spacer lengths are manufactured to order. The hubs are designed with threaded forcing-off holes.



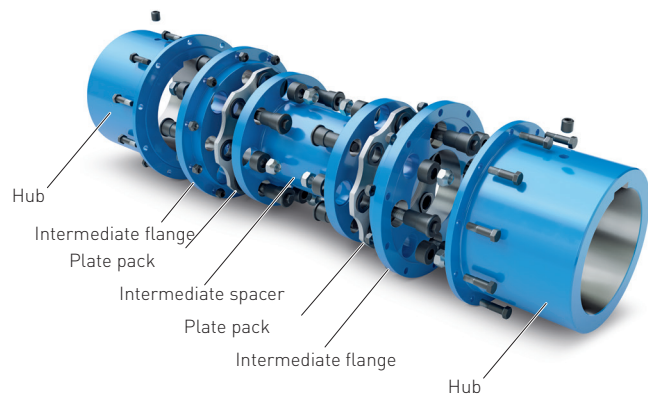
MCECM

The design of an N-ARPEX type MCECM is shown in the following illustration. The coupling comprises two hubs and a pre-assembled intermediate unit (CEC), where the plate packs are bolted together with an intermediate spacer and intermediate flanges at the factory. All that need be done at the construction site is to bolt the hubs with the intermediate flanges. The coupling is available in fixed lengths from stock. Other spacer lengths are manufactured to order. The hubs are designed with threaded forcing-off holes.



MFEFM

The following illustration shows the N-ARPEX type MFEFM. It most differs from the type MCECM by the considerably increased bore capacity, for which reason this type is intended precisely for comparatively large shaft diameters. The coupling is available in fixed lengths from stock. Other spacer lengths are manufactured to order. The hubs are designed with threaded forcing-off holes.



GENERAL

Configurations of the N-ARPEX coupling, ARN-6/-8/-10 series

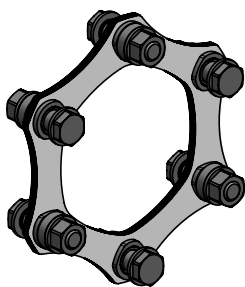
Type	Series			Description
	ARN-6	ARN-8	ARN-10	
NEN	x	x	x	Version with intermediate spacer machined all over, length variable
BEB	x	-	-	Version with intermediate spacer machined all over
MCECM	x	x	-	Version with pre-assembled intermediate unit and intermediate spacer machined all over, length variable
MFEFM	x	x	x	
NHN	x	x	x	Version with variable spacer tube – specially for greater shaft distances (up to 6,500 mm)
MCHCM	x	x	-	Version with pre-assembled intermediate unit and with variable spacer tube – specially for greater shaft distances (up to 6,500 mm)
MFHFM	x	x	x	

With the exception of the H-spacers the coupling parts of the N-ARPEX ARN-6/-8/-10 series have been machined all over. H-spacers are delivered with the spacer tube unmachined and primed.

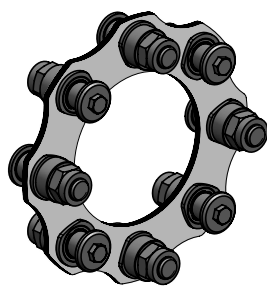
Dimension sheets and 3D models of the standard types as well as application-related coupling types are available from the DTK selection module at www.flender.com.

Plate-pack designs

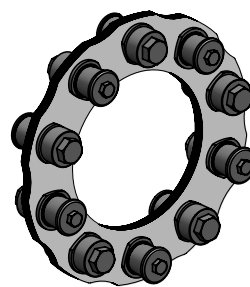
The plate packs of the N-ARPEX ARN series are designed with hexagon, octagon and decagon plates, depending on the coupling size. The number of screw connections is indicated in the denomination of the ARN-6/-8/-10 series. Hexagon plates have 6 bolting points, octagon plates have 8 bolting points and decagon plates have 10 bolting points. The hexagon plates, octagon plates and decagon plates up to size 631 are designed as ring plates. Sizes 694 to 988 are designed as segmented plates.



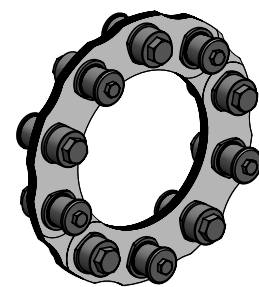
Sizes 86-6 to 343-6
(hexagon plate)



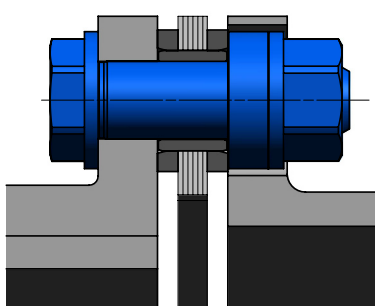
Sizes 219-8 to 631-8
(octagon plate)



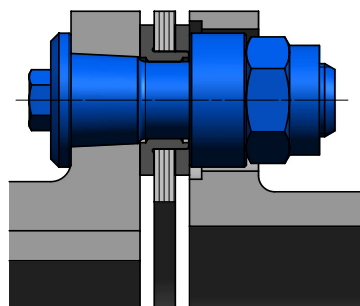
Sizes 495-10 to 631-10
(decagon plate)



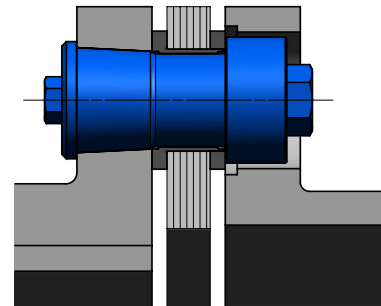
Sizes 694-10 to 988-10
(decagon plate)



Screw connection / ARN-6 series
Sizes 86-6 to 343-6



Screw connection / ARN-8 series
Sizes 219-8 to 354-8



Screw connection / ARN-8/-10 series
Sizes 387-8 to 631-8 / Sizes 495-10 to 988-10

Plate pack screw connection

In the ARN-6 series the plate pack screw connection on N-ARPEX couplings is designed in the form of a close-fitting screw connection. In the ARN-8 and ARN-10 series a conical bolt connection by Flender is used. The advantage of this screw connection is the considerably simplified installation in the case of large screw connections.

Technical data

Power ratings types NEN/NHN, BEB, MCECM/MCHCM and MFEFM/MFHFM

Size	DA	Rated torque	Maximum torque	Overload torque	Fatigue torque				Maximum speed	Maximum permissible shaft misalignment		Torsional stiffness for a plate pack			
					T_{KN}	T_{Kmax}	T_{KOL}	T_{Kw0}		$T_{Kw} = T_{Kw0} \times (1 - T_N/T_{KN})$			$\pm\Delta K_a$	$\pm\Delta K_w$	
										$T_N = 0\%T_{KN}$	25% T_{KN}				50% T_{KN}
mm		kNm	kNm	kNm	kNm	kNm	kNm	kNm	min ⁻¹	mm		MNm/rad			
86-6	6-Bolt	0,35	0,7	0,875	0,175	0,131	0,088	0,044	24000	1,2	1,0°	0,132			
103-6		0,5	1	1,25	0,25	0,188	0,125	0,063	20000	1,4		0,206			
122-6		0,95	1,9	2,375	0,475	0,356	0,238	0,119	17000	2		0,463			
133-6		1,25	2,5	3,125	0,625	0,469	0,313	0,156	15000	2,2		0,608			
159-6		2,1	4,2	5,25	1,05	0,788	0,525	0,263	13000	2,6		0,986			
174-6		2,5	5	6,25	1,3	0,975	0,65	0,325	12000	3		1,19			
184-6		3,8	7,6	9,5	1,9	1,425	0,95	0,475	11000	3,2		1,83			
203-6		5	10	12,5	2,5	1,875	1,25	0,625	10000	3,4		2,59			
217-6		6,2	12,4	15,5	3,1	2,325	1,55	0,775	9500	3,4		3,28			
251-6		10,5	21	26,25	5,5	4,125	2,75	1,375	8000	4,1		4,71			
268-6		13,8	27,6	34,5	6,9	5,175	3,45	1,725	7500	4,2		5,63			
291-6		18,2	36,4	45,5	9,1	6,825	4,55	2,275	7000	4,6		8,27			
318-6		23	46	57,5	11,5	8,625	5,75	2,875	6500	5		10,94			
343-6		28	56	70	14	10,5	7	3,5	6000	5,3		12,15			
219-8	8-Bolt	10	20	25	5	3,75	2,5	1,25	9500	1,7	0,4°	6,31			
241-8		15	30	37	7,5	5,625	3,75	1,875	8700	1,9		7,64			
262-8		20	40	50	10	7,5	5	2,5	8000	2,1		9,09			
285-8		27	54	67	13,5	10,125	6,75	3,375	7300	2,2		11,9			
302-8		35	70	87	17,5	13,125	8,75	4,375	6900	2,4		16,2			
321-8		43	86	107	21,5	16,125	10,75	5,375	6500	2,5		21,9			
354-8		56	112	140	28	21	14	7	5900	3		29,1			
387-8		72	144	180	36	27	18	9	5400	3,3		40			
411-8		93	186	232	46,5	34,875	23,25	11,625	5100	3,4		46,9			
447-8		122	244	305	61	45,75	30,5	15,25	4600	2,5		60,3			
495-8		160	320	400	80	60	40	20	4200	3		76,9			
546-8		212	424	530	106	79,5	53	26,5	3800	3,4		100			
587-8		270	540	675	135	101,25	67,5	33,75	3500	3,6		116			
631-8		350	700	875	175	131,25	87,5	43,75	3300	3,8		138			
495-10	10-Bolt	200	350	450	80	60	40	20	4200	2	0,3°	150			
546-10		270	473	608	108	81	54	27	3800	2,3		194			
587-10		352	616	792	140,8	105,6	70,4	35,2	3500	2,4		236			
631-10		450	788	1013	180	135	90	45	3300	2,5		274			
694-10		630	1103	1418	252	189	126	63	3000	2,7		405			
734-10		760	1330	1710	304	228	152	76	2800	2,8		501			
790-10		950	1663	2138	380	285	190	95	2600	3		632			
887-10		1400	2450	3150	560	420	280	140	2300	3,5		858			
988-10		2000	3500	4500	800	600	400	200	2100	3,9		1163			

Permissible shaft misalignments ΔK_a , ΔK_r and ΔK_w are maximum values and must not all occur at the same time (see table on page 6/19).

The maximum permissible radial misalignment depends on the shaft distance S. It can be determined for the stated types by using the following formulas:

NEN/NHN:
$$\Delta K_r = (S - S1) * \tan(\Delta K_w)$$

BEB, MCECM/MCHCM and MFEFM/MFHFM:
$$\Delta K_r = (LZ + S1) * \tan(\Delta K_w)$$

TKmax is permissible five times an hour.

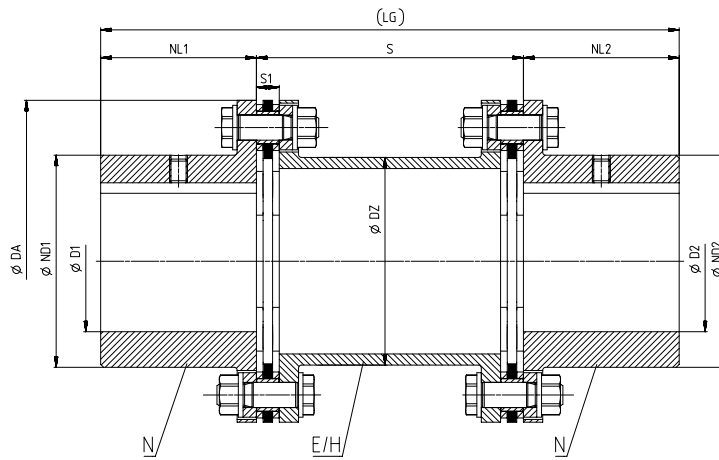
Length-related values like torsional stiffness, total weight and mass moment of inertia are listed in the tables on pages 6/20 to 6/22.

The torsional stiffness of the plate packs relates to the nominal range of the coupling. For determination of torsional stiffness for a specific operating point outside the nominal range Flender must be consulted.

TYPE NEN/NHN

Selection and ordering data

Torsionally rigid couplings of type NEN (NHN) with radially freely demountable intermediate spacer and catching device to secure the intermediate spacer in the event of plate breakage. Standard coupling type in accordance with **API 610**. Coupling type in accordance with **API 671** possible.



6

Size	Rated torque T_{KN}	Maximum speed n_{Kmax}	Dimensions in mm					Shaft distance V = preferred dimension (for type NEN)											Article No.	Weight m kg					
			D1/D2 key-way DIN 6885-1	ND1/ND2	NL1/NL2	DZ	S1	S	S _{min} (NEN) (NHN)		V	100	140	180	200	250	300	3.5" (88,9)			5" (127)	7" (177,8)	9" (228,6)	LG	Further information on structure of the article number is given in catalog MD 10.1 Part 3
mm	kNm	min ⁻¹	max.																						
86-6	0,35	24000	42	56	45	45	8,0	60	300	100	A	B	C	D	E	M	N	P		190	2LC0370-0A	■ ■ ■ -0A ■ 0	1,9		
103-6	0,5	20000	55	73	55	60	8,4	60	300	100	A	B	C	D	E	M	N	P		210	2LC0370-1A	■ ■ ■ -0A ■ 0	3,0		
122-6	0,95	17000	65	85	65	73	8,8	71	300	100	A	B	C	D	E	M	N	P	S	230	2LC0370-2A	■ ■ ■ -0A ■ 0	5,1		
133-6	1,25	15000	75	96	75	85	9,6	73	300	100	A	B	C	D	E	M	N	P	S	250	2LC0370-3A	■ ■ ■ -0A ■ 0	6,4		
159-6	2,1	13000	80	104	80	97	11,6	91	300	100	A	B	C	D	E	M	N	P	S	260	2LC0370-4A	■ ■ ■ -0A ■ 0	9,6		
174-6	2,5	12000	90	118	85	116	12,8	92	300	100	A	B	C	D	E		N	P	S	270	2LC0370-5A	■ ■ ■ -0A ■ 0	11,8		
184-6	3,8	11000	95	124	90	123	14,6	119	350	140		B	C	D	E		N	P	S	320	2LC0370-6A	■ ■ ■ -0A ■ 0	16,4		
203-6	5	10000	100	135	95	128	15,0	120	350	140		B	C	D	E		N	P	S	330	2LC0370-7A	■ ■ ■ -0A ■ 0	21,3		
217-6	6,2	9500	110	143	105	140	15,4	123	350	140		B	C	D	E		N	P	S	350	2LC0370-8A	■ ■ ■ -0A ■ 0	24,4		
251-6	10,5	8000	120	160	110	160	20,6	149	350	180			C	D	E			P	S	400	2LC0371-0A	■ ■ ■ -0A ■ 0	38,0		
268-6	13,8	7500	130	170	130	166	22,0	175	350	180			C	D	E			P	S	440	2LC0371-1A	■ ■ ■ -0A ■ 0	48,6		
291-6	18,2	7000	145	190	140	188	22,8	177	350	180			C	D	E			P	S	460	2LC0371-2A	■ ■ ■ -0A ■ 0	62,8		
318-6	23	6500	155	205	150	197	23,2	189	400	200				D	E	F		S	500	2LC0371-3A	■ ■ ■ -0A ■ 0	83,9			
343-6	28	6000	170	230	160	223	24,0	190	400	200					D	E	F		S	520	2LC0371-4A	■ ■ ■ -0A ■ 0	104		
219-8	10	9500	100	137	115	124	12,2	129	350	140		B								370	2LC0380-0A	■ ■ ■ -0A ■ 0	31,9		
241-8	15	8700	110	150	127	135	12,6	135	350	140		B								394	2LC0380-1A	■ ■ ■ -0A ■ 0	41,3		
262-8	20	8000	120	163	138	148	13,8	145	350	180			C							456	2LC0380-2A	■ ■ ■ -0A ■ 0	53,8		
285-8	27	7300	130	177	150	162	15,2	162	350	180			C							480	2LC0380-3A	■ ■ ■ -0A ■ 0	70,8		
302-8	35	6900	140	192	161	174	17,2	179	350	180			C							502	2LC0380-4A	■ ■ ■ -0A ■ 0	89,4		
321-8	43	6500	150	206	173	189	21,0	196	400	200				D						546	2LC0380-5A	■ ■ ■ -0A ■ 0	109		
354-8	56	5900	170	232	196	216	23,6	214	400	250					E					642	2LC0380-6A	■ ■ ■ -0A ■ 0	149		
387-8	72	5400	190	258	219	240	26,0	246	400	250					E					688	2LC0380-7A	■ ■ ■ -0A ■ 0	193		
411-8	93	5100	200	272	230	250	29,6	256	400	300						F				760	2LC0380-8A	■ ■ ■ -0A ■ 0	236		
447-8	122	4600	220	299	253	275	32,6	270	400	300						F				806	2LC0381-0A	■ ■ ■ -0A ■ 0	299		
495-8	160	4200	250	340	288	312	33,8	281	600	300						F				876	2LC0381-1A	■ ■ ■ -0A ■ 0	402		
546-8	212	3800	280	381	322	351	40,0	299	600	300						F				944	2LC0381-2A	■ ■ ■ -0A ■ 0	547		
587-8	270	3500	300	408	345	363	45,0	315	600	320										G 1010	2LC0381-3A	■ ■ ■ -0A ■ 0	690		
631-8	350	3300	320	435	368	399	48,8	334	600	340										G 1076	2LC0381-4A	■ ■ ■ -0A ■ 0	835		
495-10	200	4200	250	340	288	312	33,8	281	600	300						F				876	2LC0390-0A	■ ■ ■ -0A ■ 0	402		
546-10	270	3800	280	381	322	351	40,0	299	600	300							F			944	2LC0390-1A	■ ■ ■ -0A ■ 0	547		
587-10	352	3500	300	408	345	363	45,0	315	600	320										G 1010	2LC0390-2A	■ ■ ■ -0A ■ 0	690		

Size	Rated torque T_{KN}	Maximum speed n_{Kmax}	Dimensions in mm					Shaft distance V = preferred dimension (for type NEN) S										Article No.	Weight										
			D1/D2 keyway DIN 6885-1	ND1/ND2	NL1/NL2	DZ	S1	S _{min} (NEN)	S _{min} (NHN)	V	100	140	180	200	250	300	3,5" (88,9)			5" (127)	7" (177,8)	9" (228,6)	Further information on structure of the article number is given in catalog MD 10.1 Part 3						
mm	kNm	min ⁻¹	max.																				m	kg					
631-10	450	3300	320	435	368	399	48,8	334	600	340										G	1076	2LC0390-3A				-0A		0	834
694-10	630	3000	350	485	403	435	58,0	400	600	400										G	1206	2LC0390-4A				-0A		0	1213
734-10	760	2800	370	512	426	459	63,0	436	600	440										G	1292	2LC0390-5A				-0A		0	1463
790-10	950	2600	400	555	460	496	66,0	466	750	470										G	1390	2LC0390-6A				-0A		0	1837
887-10	1400	2300	450	627	518	546	78,0	543	750	550										G	1586	2LC0390-7A				-0A		0	2713
988-10	2000	2100	500	696	575	596	86,0	617	750	620										G	1770	2LC0390-8A				-0A		0	3868
Intermediate spacer	<ul style="list-style-type: none"> Intermediate spacer configured as E-spacer (conformant to API ...) → Type NEN Intermediate spacer configured as H-spacer (not conformant to API ...) → Type NHN 																			A									
∅D1	<ul style="list-style-type: none"> Without finished bore – without order code With finished bore – with order codes for diameter and tolerance (for list of order codes see pages 6/23 to 6/24) 																			L		1	9						
∅D2	<ul style="list-style-type: none"> Without finished bore – without order code With finished bore – with order codes for diameter and tolerance (for list of order codes see pages 6/23 to 6/24) 																					1	9						
Code letter for shaft distance S:	<ul style="list-style-type: none"> Metric (mm) = A, B, C, D, E, F, G (E-spacer only) Imperial (inch) = M, N, P, S (E-spacer only) Any required (mm) = Z (for E- and H-spacer "-Z" is required additionally at the end of the article no.) 																												

Hubs are designed with threaded forcing-off holes. Special lengths available upon request.

The total lengths and the weights apply to the whole coupling of type NEN with maximum bores D1/D2 and the preferred shaft distance S = V.

In cases with large shaft distances S the intermediate spacer can be designed as an H-spacer. The tube diameters here may slightly diverge. More precise coupling data in cases of variable shaft distances and E- / H-spacers are given on pages 6/20 to 6/22.

E-spacers in preferred lengths up to size 343-6 are available from stock.

Order example:

N-ARPEX coupling ARN-6 NEN, size 217-6, with shaft distance S = 140 mm (**2LC0370-8AA99-0AB0**).

Bore codes (for overview see pages 6/23 to 6/24):

- Bore dia. D1 50 H7 mm, with keyway to DIN 6885-1 P9 and set screw (**L1C**),
- Bore dia. ∅ D2 60 H7 mm, with keyway to DIN 6885-1 P9 and set screw (**M1E**).

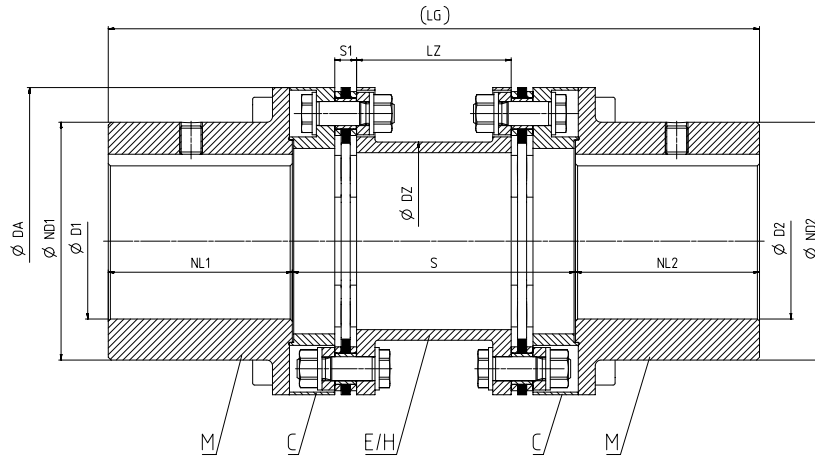
Article No.:
2LC0370-8AA99-0AB0
L1C+M1E



TYPE MCECM/MCHCM

Selection and ordering data

Torsionally rigid couplings of type MCECM (MCHCM) with radially freely demountable pre-assembled intermediate unit and catching device to secure the intermediate spacer in the event of plate breakage. Standard coupling type in accordance with **API 610**. Coupling type in accordance with **API 671** possible.

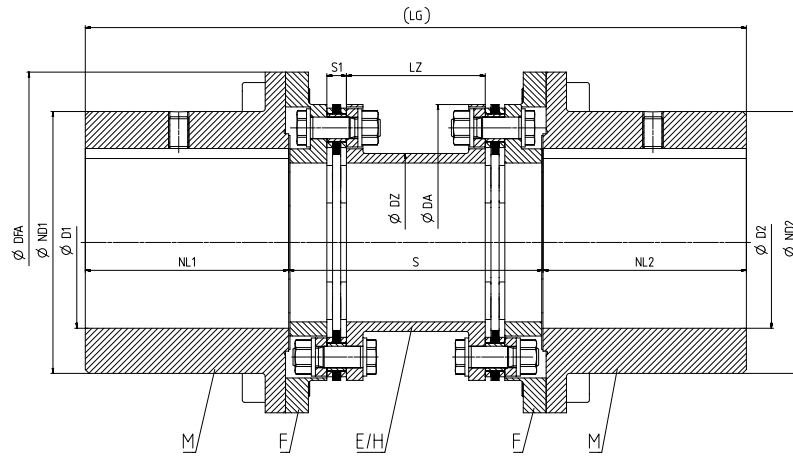


Size	Rated torque T_{KN}	Maximum speed n_{Kmax}	Dimensions in mm						Shaft distance V = preferred dimension (for type MCECM)	Article No.	Weight																		
			D1/D2 key-way DIN 6885-1	ND1/ ND2	NL1/ NL2	DZ	LZ	S1				mm	kg																
86-6	0,35	24000	42	62	42	45	84,0	8,0	100	340	140	A	B	C	D	E	N	P	S	224	2LC0370-0A	■	■	■	■	-0A	■	0	3,1
103-6	0,5	20000	55	72	55	60	83,2	8,4	100	340	140	A	B	C	D	E	N	P	S	250	2LC0370-1A	■	■	■	■	-0A	■	0	4,7
122-6	0,95	17000	70	91	70	73	82,4	8,8	111	340	140	A	B	C	D	E	N	P	S	280	2LC0370-2A	■	■	■	■	-0A	■	0	7,7
133-6	1,25	15000	80	103	80	85	80,8	9,6	113	340	140	B	C	D	E	N	P	S	300	2LC0370-3A	■	■	■	■	-0A	■	0	9,6	
159-6	2,1	13000	95	123	95	97	76,8	11,6	131	340	140	B	C	D	E	N	P	S	330	2LC0370-4A	■	■	■	■	-0A	■	0	15,9	
174-6	2,5	12000	105	136	105	116	74,4	12,8	132	340	140	B	C	D	E	N	P	S	350	2LC0370-5A	■	■	■	■	-0A	■	0	19,3	
184-6	3,8	11000	110	142	110	123	110,8	14,6	179	410	200	D	E	N	P	S	420	2LC0370-6A	■	■	■	■	-0A	■	0	26,6			
203-6	5	10000	115	150	115	128	110,0	15,0	180	410	200	D	E	N	P	S	430	2LC0370-7A	■	■	■	■	-0A	■	0	33,7			
217-6	6,2	9500	130	168	130	140	109,2	15,4	183	410	200	D	E	N	P	S	460	2LC0370-8A	■	■	■	■	-0A	■	0	40,3			
251-6	10,5	8000	150	193	150	160	138,8	20,6	219	420	250	E	N	P	S	550	2LC0371-0A	■	■	■	■	-0A	■	0	64,4				
268-6	13,8	7500	160	206	160	166	136,0	22,0	245	420	250	E	N	P	S	570	2LC0371-1A	■	■	■	■	-0A	■	0	78,8				
291-6	18,2	7000	170	221	170	188	134,4	22,8	247	420	250	E	N	P	S	590	2LC0371-2A	■	■	■	■	-0A	■	0	98,3				
318-6	23	6500	190	245	190	197	153,6	23,2	289	500	300	F	N	P	S	680	2LC0371-3A	■	■	■	■	-0A	■	0	139				
343-6	28	6000	205	267	205	223	152,0	24,0	290	500	300	F	N	P	S	710	2LC0371-4A	■	■	■	■	-0A	■	0	168				
219-8	10	9500	140	179	140	124	115,6	12,2	207	428	218	G	N	P	S	498	2LC0380-0A	■	■	■	■	-0A	■	0	50,3				
241-8	15	8700	155	201	155	135	114,8	12,6	217	432	222	G	N	P	S	532	2LC0380-1A	■	■	■	■	-0A	■	0	68,2				
262-8	20	8000	165	218	165	148	152,4	13,8	233	438	268	G	N	P	S	598	2LC0380-2A	■	■	■	■	-0A	■	0	89				
285-8	27	7300	185	239	185	162	149,6	15,2	260	448	278	G	N	P	S	648	2LC0380-3A	■	■	■	■	-0A	■	0	115				
302-8	35	6900	190	250	190	174	145,6	17,2	285	456	286	G	N	P	S	666	2LC0380-4A	■	■	■	■	-0A	■	0	140				
321-8	43	6500	205	269	205	189	158,0	21,0	308	512	312	G	N	P	S	722	2LC0380-5A	■	■	■	■	-0A	■	0	171				
354-8	56	5900	230	296	230	216	202,8	23,6	330	516	366	G	N	P	S	826	2LC0380-6A	■	■	■	■	-0A	■	0	220				
387-8	72	5400	255	329	255	240	198,0	26,0	338	492	342	G	N	P	S	852	2LC0380-7A	■	■	■	■	-0A	■	0	275				
411-8	93	5100	270	347	270	250	240,8	29,6	350	494	394	G	N	P	S	934	2LC0380-8A	■	■	■	■	-0A	■	0	332				
447-8	122	4600	290	375	290	275	234,8	32,6	372	502	402	G	N	P	S	982	2LC0381-0A	■	■	■	■	-0A	■	0	419				
495-8	160	4200	325	423	325	312	232,4	33,8	387	706	406	G	N	P	S	1056	2LC0381-1A	■	■	■	■	-0A	■	0	561				
546-8	212	3800	360	468	360	351	220,0	40,0	413	714	414	G	N	P	S	1134	2LC0381-2A	■	■	■	■	-0A	■	0	752				

Type MFEFM/MFHFM

Selection and ordering data

Torsionally rigid type MFEFM (MFHFM) couplings with enlarged bore capacity and radially freely demountable intermediate unit and catching device to secure the intermediate spacer in the event of plate breakage. Standard coupling type in accordance with **API 610**. Coupling type in accordance with **API 671** possible.



Size	Rated torque T_{KN}	Maximum speed n_{Kmax}	Dimensions in mm							Shaft distance V = preferred dimension (for type MFEFM)										Article No.	Weight m kg				
			DFA	D1/D2 key-way DIN 6885-1	ND1/ ND2	NL1/ NL2	DZ	LZ	S1	S	S _{min} (MFEFM)		S _{min} (MFHFM)		V							LG			
mm	kNm	min ⁻¹	max.																						
86-6	0,35	17000	122	70	91	70	45	84,0	8,0	100	340	140	A	B	C	D	E	N	P	S	280	2LC0370-0B	-0A	0	6,0
103-6	0,5	15000	133	80	103	80	60	83,2	8,4	100	340	140	A	B	C	D	E	N	P	S	300	2LC0370-1B	-0A	0	8,0
122-6	0,95	13000	159	95	123	95	73	82,4	8,8	111	340	140	B	C	D	E	N	P	S	330	2LC0370-2B	-0A	0	13,6	
133-6	1,25	12000	174	105	136	105	85	80,8	9,6	113	340	140	B	C	D	E	P	S		350	2LC0370-3B	-0A	0	17,1	
159-6	2,1	10000	203	115	150	115	97	76,8	11,6	131	340	140	B	C	D	E	P	S		370	2LC0370-4B	-0A	0	22,9	
174-6	2,5	9500	217	130	168	130	116	74,4	12,8	132	340	140	B	C	D	E	P	S		400	2LC0370-5B	-0A	0	26,8	
184-6	3,8	8000	251	150	193	150	123	110,8	14,6	179	410	200				D	E	S		500	2LC0370-6B	-0A	0	40,1	
203-6	5	8000	251	150	193	150	128	110,0	15,0	180	410	200				D	E	S		500	2LC0370-7B	-0A	0	52,8	
217-6	6,2	7500	268	160	206	160	140	109,2	15,4	183	410	200				D	E	S		520	2LC0370-8B	-0A	0	63,4	
251-6	10,5	6500	318	190	245	190	160	138,8	20,6	219	420	250				E	S			630	2LC0371-0B	-0A	0	109	
268-6	13,8	6000	343	205	267	205	166	136,0	22,0	245	420	250				E	S			660	2LC0371-1B	-0A	0	136	
291-6	18,2	5500	356	230	302	230	188	134,4	22,8	297	470	300				F	S			760	2LC0371-2B	-0A	0	190	
318-6	23	5500	375	245	321	245	197	153,6	23,2	289	500	300				F	S			790	2LC0371-3B	-0A	0	221	
343-6	28	4500	424	270	354	270	223	152,0	24,0	290	500	300				F	S			840	2LC0371-4B	-0A	0	284	
219-8	10	7800	267	165	219	165	124	115,6	12,2	207	428	218								G	548	2LC0380-0B	-0A	0	77,7
241-8	15	7200	289	185	241	185	135	114,8	12,6	217	432	222								G	592	2LC0380-1B	-0A	0	98,6
262-8	20	6600	314	200	262	200	148	152,4	13,8	233	438	268								G	668	2LC0380-2B	-0A	0	131
285-8	27	6100	339	215	285	215	162	149,6	15,2	260	448	278								G	708	2LC0380-3B	-0A	0	169
302-8	35	5900	356	230	302	230	174	145,6	17,2	285	456	286								G	746	2LC0380-4B	-0A	0	200
321-8	43	5600	375	245	321	245	189	158,0	21,0	308	512	312								G	802	2LC0380-5B	-0A	0	237
354-8	56	4900	424	270	354	270	216	202,8	23,6	330	516	366								G	906	2LC0380-6B	-0A	0	315
387-8	72	4500	457	295	387	295	240	198,0	26,0	338	492	342								G	932	2LC0380-7B	-0A	0	384
411-8	93	4300	481	315	411	315	250	240,8	29,6	350	494	394								G	1024	2LC0380-8B	-0A	0	460
447-8	122	4000	519	340	447	340	275	234,8	32,6	372	502	402								G	1082	2LC0381-0B	-0A	0	586
495-8	160	3700	567	380	495	380	312	232,4	33,8	387	706	406								G	1166	2LC0381-1B	-0A	0	758
546-8	212	3300	624	420	546	420	351	220,0	40,0	413	714	414								G	1254	2LC0381-2B	-0A	0	1011
587-8	270	3100	669	450	587	450	363	230,0	45,0	435	720	440								G	1340	2LC0381-3B	-0A	0	1270
631-8	350	2900	719	480	631	480	399	242,4	48,8	458	724	464								G	1424	2LC0381-4B	-0A	0	1581
495-10	200	3700	567	380	495	380	312	232,4	33,8	387	706	406								G	1166	2LC0390-0B	-0A	0	757
546-10	270	3300	624	420	546	420	351	220,0	40,0	413	714	414								G	1254	2LC0390-1B	-0A	0	1010
587-10	350	3100	669	450	587	450	363	230,0	45,0	435	720	440								G	1340	2LC0390-2B	-0A	0	1268

Size	Rated torque T_{KN}	Maximum speed n_{Kmax}	Dimensions in mm							Shaft distance S = preferred dimension (for type MFEFM)										Article No.	Weight								
			DFA	D1/D2	ND1/ND2	NL1/NL2	DZ	LZ	S1	S _{min} [MFEFM]	S _{min} [MFHFM]	V	100	140	180	200	250	300	5"			7"	9"	LG	Further information on structure of the article number is given in catalog MD 10.1 Part 3				
mm	kNm	min ⁻¹	max.							S _{min} [MFEFM]	S _{min} [MFHFM]	V	100	140	180	200	250	300	5"	7"	9"			m	kg				
631-10	450	2900	719	480	631	480	399	242,4	48,8	458	724	464										G	1424	2LC0390-3B	■ ■ ■	-0A	■	0	1578
694-10	630	2600	790	530	694	530	435	284,0	58,0	552	752	552										G	1612	2LC0390-4B	■ ■ ■	-0A	■	0	2165
734-10	750	2500	830	560	734	560	459	314,0	63,0	600	764	604										G	1724	2LC0390-5B	■ ■ ■	-0A	■	0	2586
790-10	950	2300	896	600	790	600	496	338,0	66,0	646	930	650										G	1850	2LC0390-6B	■ ■ ■	-0A	■	0	3263
887-10	1400	2000	1013	680	887	680	546	394,0	78,0	749	956	756										G	2116	2LC0390-7B	■ ■ ■	-0A	■	0	4716
988-10	2000	1800	1114	760	988	760	596	448,0	86,0	857	900	860										G	2380	2LC0390-8B	■ ■ ■	-0A	■	0	6574
Intermediate spacer	<ul style="list-style-type: none"> Intermediate spacer configured as E-spacer (conformant to API ...) → Type MFEFM Intermediate spacer configured as H-spacer (not conformant to API ...) → Type MFHFM 																			A									
ØD1	<ul style="list-style-type: none"> Without finished bore – without order code With finished bore – with order codes for diameter and tolerance (for list of order codes see pages 6/23 to 6/24) 																				1	9							
ØD2	<ul style="list-style-type: none"> Without finished bore – without order code With finished bore – with order codes for diameter and tolerance (for list of order codes see pages 6/23 to 6/24) 																				1	9							
Code letter for shaft distance S:	<ul style="list-style-type: none"> Metric (mm) = A, B, C, D, E, F, G (E-spacer only) Imperial (inch) = M, N, P, S (E-spacer only) Any required (mm) = Z (for E- and H-spacer "-Z" is required additionally at the end of the article no.) 																												

Hubs are designed with threaded forcing-off holes. Special lengths available upon request.

The total lengths, the spacer lengths and the weights apply to the whole coupling of type MFEFM with maximum bores D1/D2 and the preferred shaft distance S = V.

In cases with large shaft distances S the intermediate spacer can be designed as an H-spacer. The tube diameters here may slightly diverge. More precise coupling data in cases of variable shaft distances and E- / H-spacers are given on pages 6/20 to 6/22.

Factory-fitted plate packs in the FEF/FHF intermediate unit.

E-spacers in preferred lengths up to size 343-6 are available from stock.

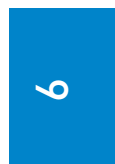
Order example:

N-ARPEX coupling ARN-6 MFEFM, size 217-6, with shaft distance S = 200 mm (**2LC0370-8BA99-0AD0**).

Bore codes (for overview see pages 6/23 to 6/24):

- Bore dia. Ø D1 80 H7 mm, with keyway to DIN 6885-1 P9 and set screw (**L1J**),
- Bore dia. Ø D2 90 H7 mm, with keyway to DIN 6885-1 P9 and set screw (**M1L**),

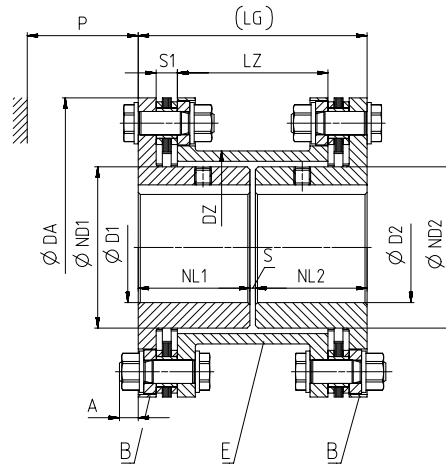
Article No.:
2LC0370-8BA99-0AD0
L1J+M1L



Type BEB

Selection and ordering data

Torsionally rigid type BEB couplings with smallest possible shaft distance. Type BEB cannot be freely demounted radially without shifting the units.



Size	Rated torque	Maximum speed	Dimensions in mm										Shaft distance	Article No.	Weight
DA	T_{KN}	n_{rmax}	D1/D2 keyway DIN 6885-1 max.	ND1/ND2	NL1/NL2	DZ	LZ	S1	S	A	P	LG	Further information on structure of the article number is given in catalog MD 10.1 Part 3		m
mm	Nm	min ⁻¹													kg
86-6	350	24000	22	35	30	45	44,0	8,0	12	8	32	72	SLC0370-0AB	■ ■ -0AA0	1,5
103-6	500	20000	38	50	34	60	43,2	8,4	4	8	32	72	SLC0370-1AB	■ ■ -0AA0	2,0
122-6	950	17000	48	62	56	73	82,4	8,8	4	8	38	116	2LC0370-2AB	■ ■ -0AA0	4,2
133-6	1250	15000	55	72	56	85	80,8	9,6	4	7	38	116	2LC0370-3AB	■ ■ -0AA0	5,1
159-6	2100	13000	65	84	57	97	76,8	11,6	6	9	48	120	2LC0370-4AB	■ ■ -0AA0	8,1
174-6	2500	12000	75	102	77	116	114,4	12,8	4	10	48	158	2LC0370-5AB	■ ■ -0AA0	11,4
184-6	3800	11000	80	106	80	123	110,8	14,6	6	15	64	166	2LC0370-6AB	■ ■ -0AA0	15,2
203-6	5000	10000	85	111	80	128	110,0	15,0	6	14	64	166	2LC0370-7AB	■ ■ -0AA0	18,2
217-6	6200	9500	90	124	81	140	109,2	15,4	4	14	66	166	2LC0370-8AB	■ ■ -0AA0	22,0
251-6	10500	8000	100	137	102	160	138,8	20,6	6	15	77	210	2LC0371-0AB	■ ■ -0AA0	35,6
268-6	13800	7500	108	143	105	166	136,0	22,0	12	11	89	222	2LC0371-1AB	■ ■ -0AA0	44,8
291-6	18200	7000	120	162	106	188	134,4	22,8	10	11	89	222	2LC0371-2AB	■ ■ -0AA0	56,7
318-6	23000	6500	130	164	118	197	153,6	23,2	6	20	100	242	2LC0371-3AB	■ ■ -0AA0	70,2
343-6	28000	6000	150	186	143	223	202,0	24,0	6	19	100	292	2LC0371-4AB	■ ■ -0AA0	87,7
ØD1															1
<ul style="list-style-type: none"> Without finished bore – without order code With finished bore – with order codes for diameter and tolerance (for list of order codes see pages 6/23 to 6/24) 															9
ØD2															1
<ul style="list-style-type: none"> Without finished bore – without order code With finished bore – with order codes for diameter and tolerance (for list of order codes see pages 6/23 to 6/24) 															9

Hubs are designed with threaded forcing-off holes. Special lengths available upon request.

The total lengths and the weights apply to the whole coupling with maximum bores D1/D2 and the preferred shaft distance S.

Order example:

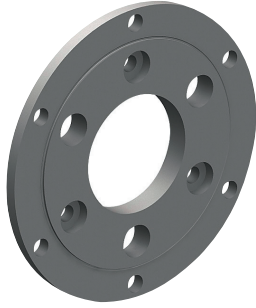
N-ARPEX coupling ARN-6 BEB, size 217-6, with shaft distance $S = 4$ mm (2LC0370-8AB99-0AA0).

Bore codes (for overview see pages 6/23 to 6/24):

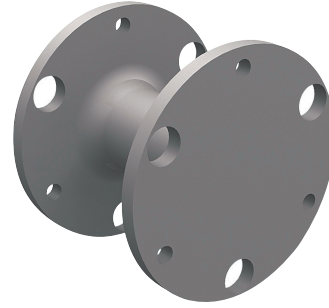
- Bore dia. ØD1 50 H7 mm, with keyway to DIN 6885-1 and set screw (L1C),
- Bore dia. ØD2 60H7 mm, with keyway to DIN 6885-1 and set screw (M1E).

Article No.:

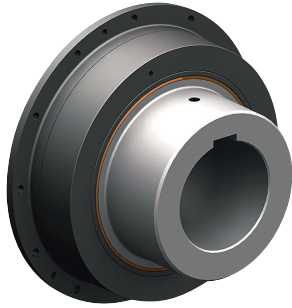
**2LC0370-8AB99-0AA0
L1C+M1E**



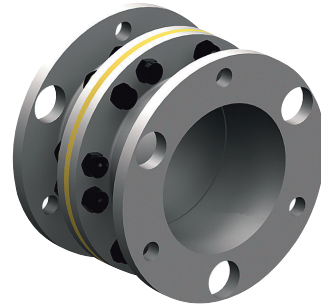
Flange version for adaptation to a customer flange



Intermediate spacer as a torsion shaft for reducing the torsional stiffness



Slipping flanges for overload protection against brief high-frequency torque shock loads



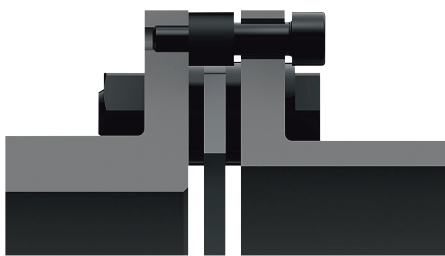
Version for avoiding leakage currents between the connected units



Slipping hubs for overload protection against brief high-frequency torque shock loads



Vertical support for avoiding excessive axial loading of the plate packs by the weight of the intermediate spacer



Axial backlash limiter

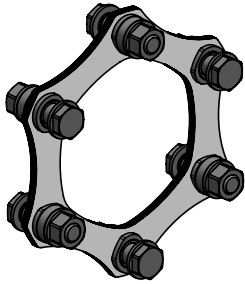


Brake disk/brake drum

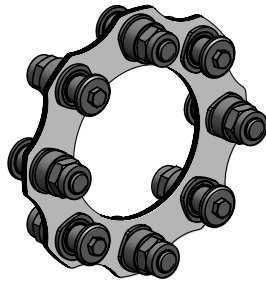


PLATE PACK

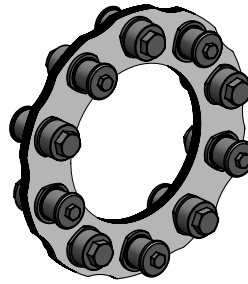
Selection and order data



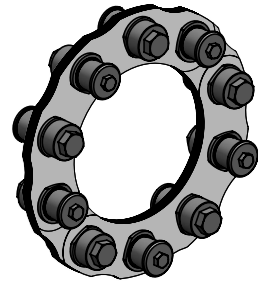
Sizes 86-6 to 343-6
(hexagon plates)



Sizes 219-8 to 631-8
(octagon plates)



Sizes 495-10 to 631-10
(decagon plates)



Sizes 694-10 to 988-10
(decagon plates/segment)

Mainly ring plates are used for plate packs. Sizes 694-10 to 988-10 plate packs are designed with segmented plates.

6

Dimensions in mm		Mass moment of inertia		Article No.	Weight
Size	S1	J			
DA		kgm ²		m	kg
86-6	8,0	0,00018	2LC0370-0LP00-0AA0	0,17	
103-6	8,4	0,00032	2LC0370-1LP00-0AA0	0,19	
122-6	8,8	0,001	2LC0370-2LP00-0AA0	0,43	
133-6	9,6	0,0014	2LC0370-3LP00-0AA0	0,49	
159-6	11,6	0,0033	2LC0370-4LP00-0AA0	0,8	
174-6	12,8	0,0047	2LC0370-5LP00-0AA0	0,93	
184-6	14,6	0,0078	2LC0370-6LP00-0AA0	1,38	
203-6	15,0	0,012	2LC0370-7LP00-0AA0	1,79	
217-6	15,4	0,018	2LC0370-8LP00-0AA0	2,25	
251-6	20,6	0,037	2LC0371-0LP00-0AA0	3,61	
268-6	22,0	0,056	2LC0371-1LP00-0AA0	4,83	
291-6	22,8	0,08	2LC0371-2LP00-0AA0	5,78	
318-6	23,2	0,13	2LC0371-3LP00-0AA0	8,12	
343-6	24,0	0,17	2LC0371-4LP00-0AA0	8,68	
219-8	12,2	0,028	2LC0380-0LP00-0AA0	3,58	
241-8	12,6	0,042	2LC0380-1LP00-0AA0	4,67	
262-8	13,8	0,067	2LC0380-2LP00-0AA0	6,05	
285-8	15,2	0,11	2LC0380-3LP00-0AA0	8,28	
302-8	17,2	0,15	2LC0380-4LP00-0AA0	10,3	
321-8	21,0	0,22	2LC0380-5LP00-0AA0	13,6	
354-8	23,6	0,34	2LC0380-6LP00-0AA0	17	
387-8	26,0	0,49	2LC0380-7LP00-0AA0	20,2	
411-8	29,6	0,7	2LC0380-8LP00-0AA0	26	
447-8	32,6	1,01	2LC0381-0LP00-0AA0	31,5	
495-8	33,8	1,54	2LC0381-1LP00-0AA0	38,7	
546-8	40,0	2,57	2LC0381-2LP00-0AA0	52,9	
587-8	45,0	3,74	2LC0381-3LP00-0AA0	67,2	
631-8	48,8	5,38	2LC0381-4LP00-0AA0	85	

Dimensions in mm		Mass moment of inertia	Article No.	Weight
Size	S1	J		m
DA		kgm ²		kg
495-10	33,8	1,76	2LC0390-0LP00-0AA0	43,4
546-10	40	2,9	2LC0390-1LP00-0AA0	58,5
587-10	45	4,19	2LC0390-2LP00-0AA0	73,7
631-10	48,8	5,98	2LC0390-3LP00-0AA0	92,6
694-10	58	11,8	2LC0390-4LP00-0AA0	148
734-10	63	16,3	2LC0390-5LP00-0AA0	182
790-10	66	23,4	2LC0390-6LP00-0AA0	226
887-10	78	43,7	2LC0390-7LP00-0AA0	335
988-10	86	75,8	2LC0390-8LP00-0AA0	468

The plate pack for the ARN-6/-8 series can be supplied as a spare part at short notice.

The plate pack is supplied with screw connection included.

Order example:

N-ARPEX plate pack ARN-8, size 354-8, complete, with screw connection:

Article No.:

2LC0380-6LP00-0AA0

CLAMPING HUB

Selection and ordering data

Type 124 and 125 standard clamping hubs can be combined with any spacer of the ARN-6 series. It should be noted here that the clamping hub can be used only as an N hub (hub core outside).

Operation

N-ARPEX clamping hubs transmit torque with the aid of a flexible pressure connection. By pulling the locking ring on using the locking screws the necessary surface pressure is applied in the shaft/hub contact area. After being pulled on the locking ring rests against the clamping hub.

Transmissible torque

The clamping connections are designed so that the specified maximum torques can be transmitted. These maximum torques must not be exceeded, even in the case of overload.

Fitting clearance and surface roughness

The transmissible torques allow for the maximum fitting clearance for a quality IT6 bore and shaft and maximum surface roughness. For other shaft tolerances reduced torques or other bore tolerances must be used.

The surface roughness of the shaft must be $\leq Ra = 1.6 \mu m$.

Preferably the mating fit G6/h6 must be used.

Divergent shaft tolerances must be specified when ordering. The article no. for the specification must end in "-Z" and include the code "Y26" for the fit.

Order example:

N-ARPEX clamping hub, type 124, size 133-6,
"-Z" with additional specifications
(2LC0370-3LM90-0AA0-Z),

Shaft dia. $\varnothing D1 = 40k6$

(LOW/Overview of order codes pages 6/23 to 6/24)

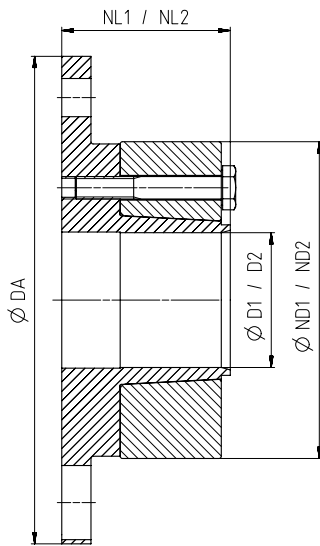
(Y26/fit specification supplied)

Article No.:

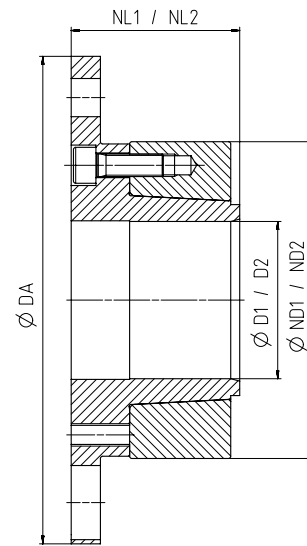
2LC0370-3LM90-0AA0-Z

LOW+Y26

{Y26:k6}



Type 124 (standard version)



Type 125

Size	Clamping hub	Dimensions in mm				Mass moment of inertia	Article No.	Weight	
		DA mm	Type	D1/D2 min.	D1/D2 max.				ND1/ND2
86-6	124	124	19	25	50	35	0,0003	2LC0370-0LM90-0AA0	0,5
	125							2LC0370-0LN90-0AA0	
103-6	124	124	25	38	67	40	0,0009	2LC0370-1LM90-0AA0	0,9
	125							2LC0370-1LN90-0AA0	
122-6	124	124	30	42	77	45	0,0021	2LC0370-2LM90-0AA0	1,5
	125							2LC0370-2LN90-0AA0	
133-6	124	124	32	50	88	50	0,0034	2LC0370-3LM90-0AA0	2,0
	125							2LC0370-3LN90-0AA0	
159-6	124	124	35	60	105	55	0,0077	2LC0370-4LM90-0AA0	3,2
	125							2LC0370-4LN90-0AA0	
174-6	124	124	40	70	120	65	0,0135	2LC0370-5LM90-0AA0	4,6
	125							2LC0370-5LN90-0AA0	
184-6	124	124	45	70	126	70	0,0195	2LC0370-6LM90-0AA0	5,9
	125							2LC0370-6LN90-0AA0	
203-6	124	124	50	80	139	75	0,0298	2LC0370-7LM90-0AA0	7,4
	125							2LC0370-7LN90-0AA0	
217-6	124	124	60	90	147	90	0,0429	2LC0370-8LM90-0AA0	9,2
	125							2LC0370-8LN90-0AA0	
251-6	124	124	70	95	168	95	0,0837	2LC0371-0LM90-0AA0	14,0
	125							2LC0371-0LN90-0AA0	
268-6	124	124	75	100	175	115	0,1236	2LC0371-1LM90-0AA0	18,5
	125							2LC0371-1LN90-0AA0	
291-6	124	124	80	120	195	125	0,1907	2LC0371-2LM90-0AA0	22,9
	125							2LC0371-2LN90-0AA0	
318-6	124	124	85	120	209	140	0,2975	2LC0371-3LM90-0AA0	31,5
	125							2LC0371-3LN90-0AA0	
343-6	124	124	95	140	234	150	0,4539	2LC0371-4LM90-0AA0	39,6
	125							2LC0371-4LN90-0AA0	

Weights and mass moments of inertia apply to a clamping hub with maximum bore D1/D2.



CLAMPING HUB

Dimensions and torques

Finished bore / shaft in standard fit	Size													
	86-6	103-6	122-6	133-6	159-6	174-6	184-6	203-6	217-6	251-6	268-6	291-6	318-6	343-6
D1 ^{G6} / _{h6}	Rated coupling torque T _{KN}													
	Nm													
mm	350	500	950	1250	2100	2400	3800	5000	6200	10500	13800	18200	23000	28000
mm	Maximum transmissible torque of the clamping hub													
	Nm													
19	400	-	-	-	-	-	-	-	-	-	-	-	-	-
20	460	-	-	-	-	-	-	-	-	-	-	-	-	-
22	470	-	-	-	-	-	-	-	-	-	-	-	-	-
24	350	-	-	-	-	-	-	-	-	-	-	-	-	-
25	370	480	-	-	-	-	-	-	-	-	-	-	-	-
28	-	870	-	-	-	-	-	-	-	-	-	-	-	-
30	-	1150	1770	-	-	-	-	-	-	-	-	-	-	-
32	-	1140	1830	2300	-	-	-	-	-	-	-	-	-	-
35	-	570	1420	2360	3050	-	-	-	-	-	-	-	-	-
38	-	830	1720	3040	2710	-	-	-	-	-	-	-	-	-
40	-	-	1370	2610	3660	3680	-	-	-	-	-	-	-	-
42	-	-	1670	2930	2180	4020	-	-	-	-	-	-	-	-
45	-	-	-	2120	3750	4110	5780	-	-	-	-	-	-	-
48	-	-	-	2480	4160	4930	6200	-	-	-	-	-	-	-
50	-	-	-	2240	2300	4300	5840	7190	-	-	-	-	-	-
55	-	-	-	-	3310	5370	6410	7970	-	-	-	-	-	-
60	-	-	-	-	3260	3730	5370	8840	7570	-	-	-	-	-
65	-	-	-	-	-	4700	6240	8890	10390	-	-	-	-	-
70	-	-	-	-	-	4150	5920	8460	10640	14050	-	-	-	-
75	-	-	-	-	-	-	-	7960	9590	15350	20710	-	-	-
80	-	-	-	-	-	-	-	7340	8850	13510	20120	31840	-	-
85	-	-	-	-	-	-	-	-	7890	16370	21130	31230	36420	-
90	-	-	-	-	-	-	-	-	6290	14300	20810	33300	39050	-
95	-	-	-	-	-	-	-	-	-	13310	18570	33530	35940	54230
100	-	-	-	-	-	-	-	-	-	-	14440	31710	37500	56580
110	-	-	-	-	-	-	-	-	-	-	-	29020	35200	56900
120	-	-	-	-	-	-	-	-	-	-	-	22600	31490	53580
130	-	-	-	-	-	-	-	-	-	-	-	-	-	50910
140	-	-	-	-	-	-	-	-	-	-	-	-	-	43600

The maximum transmissible torque of the clamping hub must not be exceeded! Further clamping hub sizes and higher torques on request.

Permissible shaft misalignments on types NEN/ NHN, BEB, MCECM/ MCHCM and MFEFM/ MFHFM

The permissible shaft misalignments ΔK_a , ΔK_r and ΔK_w are maximum values and must not all occur at the same time. The specified axial misalignments apply to the complete coupling. The permissible angular misalignments have been specified per coupling joint. As all N-ARPEX types are designed to be double-jointed, there is a direct interrelation between radial and angular misalignment.

$$\text{NEN/ NHN:} \quad \Delta K_r = (S - S1) * \tan(\Delta K_w)$$

$$\text{BEB, MCECM/ MCHCM} \\ \text{and MFEFM/ MFHFM:} \quad \Delta K_r = (LZ + S1) * \tan(\Delta K_w)$$

To determine the permissible misalignment, values must, if necessary, be converted.

Size	Permissible angular misalignment $\pm\Delta K_w$											
	0,0°	0,1°	0,2°	0,3°	0,4°	0,5°	0,6°	0,7°	0,8°	0,9°	1,0°	
DA	Permissible axial misalignment $\pm\Delta K_a$ in mm											
86-6	1,2	1,1	1,0	0,8	0,7	0,6	0,5	0,4	0,2	0,1	0,0	
103-6	1,4	1,3	1,1	1,0	0,8	0,7	0,6	0,4	0,3	0,1	0,0	
122-6	2,0	1,8	1,6	1,4	1,2	1,0	0,8	0,6	0,4	0,2	0,0	
133-6	2,2	2,0	1,8	1,5	1,3	1,1	0,9	0,7	0,4	0,2	0,0	
159-6	2,6	2,3	2,1	1,8	1,6	1,3	1,0	0,8	0,5	0,3	0,0	
174-6	3,0	2,7	2,4	2,1	1,8	1,5	1,2	0,9	0,6	0,3	0,0	
184-6	3,2	2,9	2,6	2,2	1,9	1,6	1,3	1,0	0,6	0,3	0,0	
203-6	3,4	3,1	2,7	2,4	2,0	1,7	1,4	1,0	0,7	0,3	0,0	
217-6	3,4	3,1	2,7	2,4	2,0	1,7	1,4	1,0	0,7	0,3	0,0	
251-6	4,1	3,7	3,3	2,9	2,5	2,1	1,6	1,2	0,8	0,4	0,0	
268-6	4,2	3,8	3,4	2,9	2,5	2,1	1,7	1,3	0,8	0,4	0,0	
291-6	4,6	4,1	3,7	3,2	2,8	2,3	1,8	1,4	0,9	0,5	0,0	
318-6	5,0	4,5	4,0	3,5	3,0	2,5	2,0	1,5	1,0	0,5	0,0	
343-6	5,3	4,8	4,2	3,7	3,2	2,7	2,1	1,6	1,1	0,5	0,0	
219-8	1,7	1,28	0,85	0,43	0,0	-	-	-	-	-	-	-
241-8	1,9	1,43	0,95	0,48	0,0	-	-	-	-	-	-	-
262-8	2,1	1,58	1,05	0,53	0,0	-	-	-	-	-	-	-
285-8	2,2	1,65	1,10	0,55	0,0	-	-	-	-	-	-	-
302-8	2,4	1,80	1,20	0,60	0,0	-	-	-	-	-	-	-
321-8	2,5	1,88	1,25	0,63	0,0	-	-	-	-	-	-	-
354-8	3	2,25	1,50	0,75	0,0	-	-	-	-	-	-	-
387-8	3,3	2,48	1,65	0,83	0,0	-	-	-	-	-	-	-
411-8	3,4	2,55	1,70	0,85	0,0	-	-	-	-	-	-	-
447-8	2,5	1,88	1,25	0,63	0,0	-	-	-	-	-	-	-
495-8	3	2,25	1,50	0,75	0,0	-	-	-	-	-	-	-
546-8	3,4	2,55	1,70	0,85	0,0	-	-	-	-	-	-	-
587-8	3,6	2,70	1,80	0,90	0,0	-	-	-	-	-	-	-
631-8	3,8	2,85	1,90	0,95	0,0	-	-	-	-	-	-	-
495-10	2	1,33	0,67	0,0	-	-	-	-	-	-	-	-
546-10	2,3	1,53	0,77	0,0	-	-	-	-	-	-	-	-
587-10	2,4	1,60	0,80	0,0	-	-	-	-	-	-	-	-
631-10	2,5	1,67	0,83	0,0	-	-	-	-	-	-	-	-
694-10	2,7	1,35	0,0	-	-	-	-	-	-	-	-	-
734-10	2,8	1,40	0,0	-	-	-	-	-	-	-	-	-
790-10	3	1,50	0,0	-	-	-	-	-	-	-	-	-
887-10	3,5	1,75	0,0	-	-	-	-	-	-	-	-	-
988-10	3,9	1,95	0,0	-	-	-	-	-	-	-	-	-

OTHER DATA

Technical data

Length-dependent specifications of types NEN/ NHN, BEB, MCECM/MCHCM and MFEFM/MFHFM

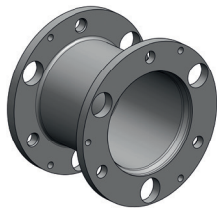
A variant with an E-spacer is standardly provided for for each N-ARPEX type. This has been machined all over in accordance with the requirements of API 610 and 671. Particularly for large shaft distances S and therefore for correspondingly long intermediate spacer it is usual to leave the inside and outside diameters of the tube in the condition in which it was delivered. These spacers are then referred to as H-spacers.

If a coupling is fitted with an H-spacer, the type designation changes accordingly. For example, an NEN becomes an NHN, an MFEFM becomes an MFHFM. No version with an H-spacer is provided for for the BEB type. Length-dependent technical specifications for the various coupling types are shown on the following table.

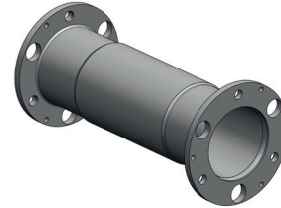
The shaft distance S must be specified in mm. The specifications with regard to weight and mass moment of inertia refer to the whole coupling with maximum bores D1/ D2.

The values for torsional stiffness apply to the whole coupling (not including the hubs and customer shafts) and refer to the rated coupling torque T_{KN} . For determination of torsional stiffness for a specific operating point outside the nominal range Flender must be consulted.

Configuration with E-spacer

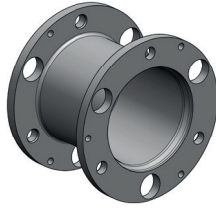


Configuration with H-spacer

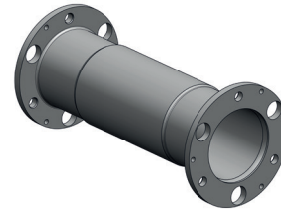


DA	Type	m kg	J kgm ²	C _T MNm/rad	DA	Type	m kg	J kgm ²	C _T MNm/rad
86-6	NEN	1,55 + 0,003 x S	0,001 + 0,000002 x S	1/(1/0,08 + S/15)	86-6	NHN	1,11 + 0,005 x S	0,001 + 0,000003 x S	1/(1/0,05 + S/25)
	BEB	1,42 + 0,003 x S	0,001 + 0,000002 x S	1/(1/0,06 + S/15)		-	-	-	-
	MCECM	2,64 + 0,003 x S	0,003 + 0,000002 x S	1/(1/0,09 + S/15)		MCHCM	2,13 + 0,005 x S	0,003 + 0,000003 x S	1/(1/0,06 + S/25)
	MFEFM	5,54 + 0,003 x S	0,01 + 0,000002 x S	1/(1/0,09 + S/15)		MFHFM	5,03 + 0,005 x S	0,01 + 0,000003 x S	1/(1/0,06 + S/25)
103-6	NEN	2,52 + 0,005 x S	0,004 + 0,000004 x S	1/(1/0,11 + S/42)	103-6	NHN	1,91 + 0,008 x S	0,003 + 0,000007 x S	1/(1/0,09 + S/68)
	BEB	2,01 + 0,005 x S	0,003 + 0,000004 x S	1/(1/0,11 + S/42)		-	-	-	-
	MCECM	4 + 0,005 x S	0,006 + 0,000004 x S	1/(1/0,12 + S/42)		MCHCM	3,28 + 0,008 x S	0,006 + 0,000007 x S	1/(1/0,1 + S/68)
	MFEFM	7,28 + 0,005 x S	0,017 + 0,000004 x S	1/(1/0,12 + S/42)		MFHFM	6,56 + 0,008 x S	0,016 + 0,000007 x S	1/(1/0,1 + S/68)
122-6	NEN	4,39 + 0,007 x S	0,009 + 0,000008 x S	1/(1/0,26 + S/82)	122-6	NHN	3,72 + 0,01 x S	0,008 + 0,000012 x S	1/(1/0,21 + S/122)
	BEB	4,19 + 0,007 x S	0,008 + 0,000008 x S	1/(1/0,2 + S/82)		-	-	-	-
	MCECM	6,78 + 0,007 x S	0,015 + 0,000008 x S	1/(1/0,29 + S/82)		MCHCM	6 + 0,01 x S	0,014 + 0,000012 x S	1/(1/0,22 + S/122)
	MFEFM	12,6 + 0,007 x S	0,042 + 0,000008 x S	1/(1/0,29 + S/82)		MFHFM	11,82 + 0,01 x S	0,041 + 0,000012 x S	1/(1/0,22 + S/122)
133-6	NEN	5,5 + 0,009 x S	0,013 + 0,000014 x S	1/(1/0,33 + S/142)	133-6	NHN	4,52 + 0,013 x S	0,012 + 0,000022 x S	1/(1/0,28 + S/221)
	BEB	5,09 + 0,009 x S	0,011 + 0,000014 x S	1/(1/0,27 + S/142)		-	-	-	-
	MCECM	8,44 + 0,009 x S	0,023 + 0,000014 x S	1/(1/0,36 + S/142)		MCHCM	7,29 + 0,013 x S	0,021 + 0,000022 x S	1/(1/0,29 + S/221)
	MFEFM	15,86 + 0,009 x S	0,064 + 0,000014 x S	1/(1/0,36 + S/142)		MFHFM	14,71 + 0,013 x S	0,062 + 0,000022 x S	1/(1/0,29 + S/221)
159-6	NEN	8,54 + 0,011 x S	0,028 + 0,000023 x S	1/(1/0,54 + S/234)	159-6	NHN	7,17 + 0,017 x S	0,025 + 0,000037 x S	1/(1/0,45 + S/373)
	BEB	8 + 0,011 x S	0,026 + 0,000023 x S	1/(1/0,45 + S/234)		-	-	-	-
	MCECM	14,35 + 0,011 x S	0,055 + 0,000023 x S	1/(1/0,6 + S/234)		MCHCM	12,76 + 0,017 x S	0,051 + 0,000037 x S	1/(1/0,47 + S/373)
	MFEFM	21,37 + 0,011 x S	0,068 + 0,000023 x S	1/(1/0,6 + S/234)		MFHFM	19,78 + 0,017 x S	0,064 + 0,000037 x S	1/(1/0,47 + S/373)
174-6	NEN	10,57 + 0,013 x S	0,042 + 0,000039 x S	1/(1/0,64 + S/394)	174-6	NHN	8,79 + 0,02 x S	0,036 + 0,000065 x S	1/(1/0,55 + S/652)
	BEB	11,36 + 0,013 x S	0,041 + 0,000039 x S	1/(1/0,52 + S/394)		-	-	-	-
	MCECM	17,54 + 0,013 x S	0,08 + 0,000039 x S	1/(1/0,68 + S/394)		MCHCM	15,46 + 0,02 x S	0,073 + 0,000065 x S	1/(1/0,57 + S/652)
	MFEFM	25,02 + 0,013 x S	0,146 + 0,000039 x S	1/(1/0,68 + S/394)		MFHFM	22,95 + 0,02 x S	0,139 + 0,000065 x S	1/(1/0,57 + S/652)
184-6	NEN	13,94 + 0,017 x S	0,065 + 0,000059 x S	1/(1/1 + S/597)	184-6	NHN	12,36 + 0,023 x S	0,059 + 0,000083 x S	1/(1/0,89 + S/839)
	BEB	15,1 + 0,017 x S	0,066 + 0,000059 x S	1/(1/0,81 + S/597)		-	-	-	-
	MCECM	23,12 + 0,017 x S	0,081 + 0,000059 x S	1/(1/1,11 + S/597)		MCHCM	21,18 + 0,023 x S	0,074 + 0,000083 x S	1/(1/0,95 + S/839)
	MFEFM	36,59 + 0,017 x S	0,267 + 0,000059 x S	1/(1/1,11 + S/597)		MFHFM	34,65 + 0,023 x S	0,259 + 0,000083 x S	1/(1/0,95 + S/839)

Configuration with E-spacer



Configuration with H-spacer

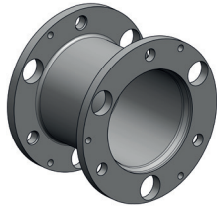


DA	Type	m kg	J kgm ²	C _T MNm/rad	DA	Type	m kg	J kgm ²	C _T MNm/rad
203-6	NEN	18,62 + 0,019 x S	0,102 + 0,00007 x S	1/(1/1,44 + S/705)	203-6	NHN	16,56 + 0,027 x S	0,093 + 0,0001 x S	1/(1/1,23 + S/1049)
	BEB	18,09 + 0,019 x S	0,096 + 0,00007 x S	1/(1/1,13 + S/705)		-	-	-	-
	MCECM	29,96 + 0,019 x S	0,185 + 0,00007 x S	1/(1/1,65 + S/705)		MCHCM	27,42 + 0,027 x S	0,174 + 0,0001 x S	1/(1/1,33 + S/1049)
	MFEFM	49,06 + 0,019 x S	0,414 + 0,00007 x S	1/(1/1,65 + S/705)		MFHFM	46,52 + 0,027 x S	0,403 + 0,0001 x S	1/(1/1,33 + S/1049)
217-6	NEN	21,68 + 0,019 x S	0,137 + 0,000087 x S	1/(1/1,84 + S/870)	217-6	NHN	18,96 + 0,03 x S	0,123 + 0,00014 x S	1/(1/1,52 + S/1413)
	BEB	21,93 + 0,019 x S	0,131 + 0,000087 x S	1/(1/1,43 + S/870)		-	-	-	-
	MCECM	36,46 + 0,019 x S	0,262 + 0,000087 x S	1/(1/2,11 + S/870)		MCHCM	33,11 + 0,03 x S	0,245 + 0,00014 x S	1/(1/1,63 + S/1413)
	MFEFM	59,53 + 0,019 x S	0,579 + 0,000087 x S	1/(1/2,11 + S/870)		MFHFM	56,18 + 0,03 x S	0,562 + 0,00014 x S	1/(1/1,63 + S/1413)
251-6	NEN	32,32 + 0,032 x S	0,271 + 0,00018 x S	1/(1/2,24 + S/1827)	251-6	NHN	29,54 + 0,042 x S	0,253 + 0,00025 x S	1/(1/2,05 + S/2505)
	BEB	35,42 + 0,032 x S	0,276 + 0,00018 x S	1/(1/1,85 + S/1827)		-	-	-	-
	MCECM	56,48 + 0,032 x S	0,539 + 0,00018 x S	1/(1/2,45 + S/1827)		MCHCM	53 + 0,042 x S	0,516 + 0,00025 x S	1/(1/2,18 + S/2505)
	MFEFM	101,1 + 0,032 x S	1,397 + 0,00018 x S	1/(1/2,45 + S/1827)		MFHFM	97,57 + 0,042 x S	1,374 + 0,00025 x S	1/(1/2,18 + S/2505)
268-6	NEN	44,91 + 0,02 x S	0,434 + 0,00013 x S	1/(1/2,78 + S/2063)	268-6	NHN	41,38 + 0,043 x S	0,41 + 0,00028 x S	1/(1/2,52 + S/2803)
	BEB	44,58 + 0,02 x S	0,425 + 0,00013 x S	1/(1/2,27 + S/2063)		-	-	-	-
	MCECM	73,71 + 0,02 x S	0,8 + 0,00013 x S	1/(1/3,07 + S/2063)		MCHCM	68,56 + 0,043 x S	0,765 + 0,00028 x S	1/(1/2,69 + S/2803)
	MFEFM	131,4 + 0,02 x S	2,07 + 0,00013 x S	1/(1/3,07 + S/2063)		MFHFM	126,3 + 0,043 x S	2,035 + 0,00028 x S	1/(1/2,69 + S/2803)
291-6	NEN	55,18 + 0,042 x S	0,634 + 0,00034 x S	1/(1/3,77 + S/3400)	291-6	NHN	51,32 + 0,056 x S	0,598 + 0,00046 x S	1/(1/3,48 + S/4627)
	BEB	56,23 + 0,042 x S	0,624 + 0,00034 x S	1/(1/3,17 + S/3400)		-	-	-	-
	MCECM	87,66 + 0,042 x S	1,124 + 0,00034 x S	1/(1/4,09 + S/3400)		MCHCM	82,87 + 0,056 x S	1,08 + 0,00046 x S	1/(1/3,67 + S/4627)
	MFEFM	176,8 + 0,042 x S	3,213 + 0,00034 x S	1/(1/4,09 + S/3400)		MFHFM	171,4 + 0,056 x S	3,163 + 0,00046 x S	1/(1/3,67 + S/4627)
318-6	NEN	72,12 + 0,059 x S	0,979 + 0,0005 x S	1/(1/5,13 + S/5040)	318-6	NHN	67,86 + 0,074 x S	0,936 + 0,00065 x S	1/(1/4,81 + S/6527)
	BEB	69,81 + 0,059 x S	0,922 + 0,0005 x S	1/(1/4,29 + S/5040)		-	-	-	-
	MCECM	121,4 + 0,059 x S	1,89 + 0,0005 x S	1/(1/5,72 + S/5040)		MCHCM	115,6 + 0,074 x S	1,832 + 0,00065 x S	1/(1/5,2 + S/6527)
	MFEFM	203,7 + 0,059 x S	4,214 + 0,0005 x S	1/(1/5,72 + S/5040)		MFHFM	198 + 0,074 x S	4,157 + 0,00065 x S	1/(1/5,2 + S/6527)
343-6	NEN	89,26 + 0,075 x S	1,394 + 0,00081 x S	1/(1/5,26 + S/8178)	343-6	NHN	84,41 + 0,091 x S	1,332 + 0,001 x S	1/(1/5,07 + S/10323)
	BEB	87,3 + 0,075 x S	1,322 + 0,00081 x S	1/(1/4,55 + S/8178)		-	-	-	-
	MCECM	145,8 + 0,075 x S	2,639 + 0,00081 x S	1/(1/5,62 + S/8178)		MCHCM	139,3 + 0,091 x S	2,556 + 0,001 x S	1/(1/5,33 + S/10323)
	MFEFM	261,5 + 0,075 x S	6,626 + 0,00081 x S	1/(1/5,62 + S/8178)		MFHFM	255 + 0,091 x S	6,542 + 0,001 x S	1/(1/5,33 + S/10323)
219-8	NEN	28,17 + 0,027 x S	0,177 + 0,000089 x S	1/(1/3,98 + S/889)	219-8	NHN	26,88 + 0,035 x S	0,172 + 0,00012 x S	1/(1/3,35 + S/1176)
	MCECM	44,48 + 0,027 x S	0,338 + 0,000089 x S	1/(1/6,11 + S/889)		MCHCM	42,52 + 0,035 x S	0,33 + 0,00012 x S	1/(1/4,3 + S/1176)
	MFEFM	71,89 + 0,027 x S	0,703 + 0,000089 x S	1/(1/6,11 + S/889)		MFHFM	69,94 + 0,035 x S	0,695 + 0,00012 x S	1/(1/4,3 + S/1176)
241-8	NEN	36,79 + 0,032 x S	0,276 + 0,00013 x S	1/(1/4,69 + S/1264)	241-8	NHN	34,62 + 0,044 x S	0,266 + 0,00018 x S	1/(1/3,88 + S/1760)
	MCECM	61,04 + 0,032 x S	0,56 + 0,00013 x S	1/(1/6,74 + S/1264)		MCHCM	57,91 + 0,044 x S	0,546 + 0,00018 x S	1/(1/4,73 + S/1760)
	MFEFM	91,45 + 0,032 x S	1,074 + 0,00013 x S	1/(1/6,74 + S/1264)		MFHFM	88,32 + 0,044 x S	1,06 + 0,00018 x S	1/(1/4,73 + S/1760)
262-8	NEN	46,53 + 0,04 x S	0,414 + 0,00019 x S	1/(1/5,4 + S/1884)	262-8	NHN	44,21 + 0,054 x S	0,402 + 0,00025 x S	1/(1/4,72 + S/2549)
	MCECM	78,23 + 0,04 x S	0,846 + 0,00019 x S	1/(1/7,22 + S/1884)		MCHCM	74,72 + 0,054 x S	0,828 + 0,00025 x S	1/(1/5,65 + S/2549)
	MFEFM	120,1 + 0,04 x S	1,692 + 0,00019 x S	1/(1/7,22 + S/1884)		MFHFM	116,5 + 0,054 x S	1,673 + 0,00025 x S	1/(1/5,65 + S/2549)
285-8	NEN	61,59 + 0,051 x S	0,656 + 0,00028 x S	1/(1/7,04 + S/2836)	285-8	NHN	59,68 + 0,064 x S	0,643 + 0,00035 x S	1/(1/6,46 + S/3534)
	MCECM	100,8 + 0,051 x S	1,315 + 0,00028 x S	1/(1/9,31 + S/2836)		MCHCM	97,63 + 0,064 x S	1,296 + 0,00035 x S	1/(1/7,87 + S/3534)
	MFEFM	155 + 0,051 x S	2,552 + 0,00028 x S	1/(1/9,31 + S/2836)		MFHFM	151,8 + 0,064 x S	2,533 + 0,00035 x S	1/(1/7,87 + S/3534)
302-8	NEN	78,21 + 0,062 x S	0,948 + 0,00039 x S	1/(1/9,87 + S/3948)	302-8	NHN	75,6 + 0,078 x S	0,928 + 0,00049 x S	1/(1/8,95 + S/4945)
	MCECM	122,3 + 0,062 x S	1,774 + 0,00039 x S	1/(1/13,4 + S/3948)		MCHCM	118,1 + 0,078 x S	1,744 + 0,00049 x S	1/(1/11,1 + S/4945)
	MFEFM	182 + 0,062 x S	3,359 + 0,00039 x S	1/(1/13,4 + S/3948)		MFHFM	177,7 + 0,078 x S	3,329 + 0,00049 x S	1/(1/11,1 + S/4945)
321-8	NEN	96,07 + 0,066 x S	1,317 + 0,0005 x S	1/(1/13,9 + S/5053)	321-8	NHN	92,41 + 0,086 x S	1,285 + 0,00065 x S	1/(1/12,2 + S/6577)
	MCECM	150 + 0,066 x S	2,469 + 0,0005 x S	1/(1/20,1 + S/5053)		MCHCM	144,2 + 0,086 x S	2,419 + 0,00065 x S	1/(1/15,4 + S/6577)
	MFEFM	216,6 + 0,066 x S	4,48 + 0,0005 x S	1/(1/20,1 + S/5053)		MFHFM	210,8 + 0,086 x S	4,43 + 0,00065 x S	1/(1/15,4 + S/6577)
354-8	NEN	129,1 + 0,079 x S	2,163 + 0,00079 x S	1/(1/18,2 + S/7977)	354-8	NHN	126 + 0,098 x S	2,129 + 0,00098 x S	1/(1/16,7 + S/9874)
	MCECM	191,4 + 0,079 x S	3,866 + 0,00079 x S	1/(1/24,7 + S/7977)		MCHCM	186 + 0,098 x S	3,809 + 0,00098 x S	1/(1/20,8 + S/9874)
	MFEFM	286,5 + 0,079 x S	7,246 + 0,00079 x S	1/(1/24,7 + S/7977)		MFHFM	281,2 + 0,098 x S	7,189 + 0,00098 x S	1/(1/20,8 + S/9874)

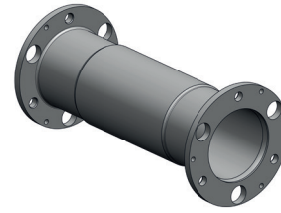


OTHER DATA

Configuration with E-spacer



Configuration with H-spacer



DA	Type	m kg	J kgm ²	C _T MNm/rad	DA	Type	m kg	J kgm ²	C _T MNm/rad
387-8	NEN	169,6 + 0,093 x S	3,414 + 0,0012 x S	1/(1/25,3 + S/11742)	387-8	NHN	164,5 + 0,122 x S	3,343 + 0,0015 x S	1/(1/22,8 + S/15253)
	MCECM	242,5 + 0,093 x S	5,88 + 0,0012 x S	1/(1/31,5 + S/11742)		MCHCM	234,9 + 0,122 x S	5,777 + 0,0015 x S	1/(1/26,4 + S/15253)
	MFEFM	351,7 + 0,093 x S	10,62 + 0,0012 x S	1/(1/31,5 + S/11742)		MFHFM	344,1 + 0,122 x S	10,51 + 0,0015 x S	1/(1/26,4 + S/15253)
411-8	NEN	201,9 + 0,113 x S	4,565 + 0,0015 x S	1/(1/29,4 + S/15183)	411-8	NHN	196,8 + 0,141 x S	4,49 + 0,0019 x S	1/(1/27,1 + S/18813)
	MCECM	287,1 + 0,113 x S	7,821 + 0,0015 x S	1/(1/36 + S/15183)		MCHCM	279,5 + 0,141 x S	7,712 + 0,0019 x S	1/(1/31,3 + S/18813)
	MFEFM	415,8 + 0,113 x S	14,1 + 0,0015 x S	1/(1/36 + S/15183)		MFHFM	408,1 + 0,141 x S	13,99 + 0,0019 x S	1/(1/31,3 + S/18813)
447-8	NEN	260,7 + 0,129 x S	6,985 + 0,0021 x S	1/(1/38 + S/21062)	447-8	NHN	255,1 + 0,157 x S	6,883 + 0,0026 x S	1/(1/35,1 + S/25615)
	MCECM	367,1 + 0,129 x S	11,74 + 0,0021 x S	1/(1/46,5 + S/21062)		MCHCM	358,7 + 0,157 x S	11,59 + 0,0026 x S	1/(1/40,9 + S/25615)
	MFEFM	534,1 + 0,129 x S	21,22 + 0,0021 x S	1/(1/46,5 + S/21062)		MFHFM	525,6 + 0,157 x S	21,07 + 0,0026 x S	1/(1/40,9 + S/25615)
495-8	NEN	354,4 + 0,157 x S	11,61 + 0,0033 x S	1/(1/46,4 + S/33418)	495-8	NHN	345 + 0,2 x S	11,39 + 0,0042 x S	1/(1/43 + S/42683)
	MCECM	497,5 + 0,157 x S	19,74 + 0,0033 x S	1/(1/54,5 + S/33418)		MCHCM	483,5 + 0,2 x S	19,42 + 0,0042 x S	1/(1/48,2 + S/42683)
	MFEFM	693,8 + 0,157 x S	33,95 + 0,0033 x S	1/(1/54,5 + S/33418)		MFHFM	679,8 + 0,2 x S	33,62 + 0,0042 x S	1/(1/48,2 + S/42683)
546-8	NEN	483,3 + 0,212 x S	19,43 + 0,0056 x S	1/(1/59 + S/56448)	546-8	NHN	474 + 0,255 x S	19,16 + 0,0068 x S	1/(1/56,3 + S/67807)
	MCECM	663,8 + 0,212 x S	32,27 + 0,0056 x S	1/(1/67 + S/56448)		MCHCM	649,6 + 0,255 x S	31,86 + 0,0068 x S	1/(1/62,2 + S/67807)
	MFEFM	923,1 + 0,212 x S	55,39 + 0,0056 x S	1/(1/67 + S/56448)		MFHFM	908,9 + 0,255 x S	54,99 + 0,0068 x S	1/(1/62,2 + S/67807)
587-8	NEN	600,7 + 0,279 x S	27,94 + 0,0076 x S	1/(1/67,3 + S/76570)	587-8	NHN	590 + 0,324 x S	27,6 + 0,0088 x S	1/(1/65 + S/88708)
	MCECM	821,9 + 0,279 x S	45,85 + 0,0076 x S	1/(1/75,3 + S/76570)		MCHCM	806 + 0,324 x S	45,37 + 0,0088 x S	1/(1/71,2 + S/88708)
	MFEFM	1147 + 0,279 x S	79,25 + 0,0076 x S	1/(1/75,3 + S/76570)		MFHFM	1131 + 0,324 x S	78,77 + 0,0088 x S	1/(1/71,2 + S/88708)
631-8	NEN	731,9 + 0,302 x S	39,04 + 0,01 x S	1/(1/79,6 + S/102143)	631-8	NHN	715,1 + 0,361 x S	38,39 + 0,012 x S	1/(1/76,3 + S/123294)
	MCECM	1006 + 0,302 x S	64,52 + 0,01 x S	1/(1/88,2 + S/102143)		MCHCM	981,7 + 0,361 x S	63,61 + 0,012 x S	1/(1/82,6 + S/123294)
	MFEFM	1441 + 0,302 x S	114,7 + 0,01 x S	1/(1/88,2 + S/102143)		MFHFM	1417 + 0,361 x S	113,8 + 0,012 x S	1/(1/82,6 + S/123294)
495-10	NEN	355,1 + 0,157 x S	11,7 + 0,0033 x S	1/(1/113 + S/33418)	495-10	NHN	345,7 + 0,2 x S	11,47 + 0,0042 x S	1/(1/94,7 + S/42683)
	MFEFM	693 + 0,157 x S	33,97 + 0,0033 x S	1/(1/176 + S/33418)		MFHFM	678,9 + 0,2 x S	33,65 + 0,0042 x S	1/(1/124 + S/42683)
546-10	NEN	483,7 + 0,212 x S	19,56 + 0,0056 x S	1/(1/138 + S/56448)	546-10	NHN	474,4 + 0,255 x S	19,28 + 0,0068 x S	1/(1/124 + S/67807)
	MFEFM	921,8 + 0,212 x S	55,43 + 0,0056 x S	1/(1/190 + S/56448)		MFHFM	907,5 + 0,255 x S	55,03 + 0,0068 x S	1/(1/156 + S/67807)
587-10	NEN	600,5 + 0,279 x S	28,09 + 0,0076 x S	1/(1/165 + S/76570)	587-10	NHN	589,9 + 0,324 x S	27,76 + 0,0088 x S	1/(1/152 + S/88708)
	MFEFM	1145 + 0,279 x S	79,29 + 0,0076 x S	1/(1/223 + S/76570)		MFHFM	1129 + 0,324 x S	78,81 + 0,0088 x S	1/(1/191 + S/88708)
631-10	NEN	731,3 + 0,302 x S	39,23 + 0,01 x S	1/(1/187 + S/102143)	631-10	NHN	714,5 + 0,361 x S	38,57 + 0,012 x S	1/(1/169 + S/123294)
	MFEFM	1438 + 0,302 x S	114,8 + 0,01 x S	1/(1/241 + S/102143)		MFHFM	1414 + 0,361 x S	113,9 + 0,012 x S	1/(1/204 + S/123294)
694-10	NEN	1057 + 0,39 x S	69,77 + 0,015 x S	1/(1/293 + S/154224)	694-10	NHN	1028 + 0,487 x S	68,47 + 0,019 x S	1/(1/257 + S/193881)
	MFEFM	1950 + 0,39 x S	188,1 + 0,015 x S	1/(1/412 + S/154224)		MFHFM	1906 + 0,487 x S	186,2 + 0,019 x S	1/(1/322 + S/193881)
734-10	NEN	1265 + 0,45 x S	94,03 + 0,02 x S	1/(1/373 + S/196935)	734-10	NHN	1229 + 0,563 x S	92,27 + 0,025 x S	1/(1/325 + S/247708)
	MFEFM	2314 + 0,45 x S	248,7 + 0,02 x S	1/(1/542 + S/196935)		MFHFM	2260 + 0,563 x S	246,1 + 0,025 x S	1/(1/414 + S/247708)
790-10	NEN	1587 + 0,53 x S	136,9 + 0,027 x S	1/(1/467 + S/270335)	790-10	NHN	1544 + 0,663 x S	134,4 + 0,034 x S	1/(1/409 + S/340076)
	MFEFM	2919 + 0,53 x S	363,4 + 0,027 x S	1/(1/677 + S/270335)		MFHFM	2852 + 0,663 x S	359,6 + 0,034 x S	1/(1/522 + S/340076)
887-10	NEN	2335 + 0,687 x S	256 + 0,042 x S	1/(1/644 + S/418343)	887-10	NHN	2278 + 0,844 x S	252 + 0,051 x S	1/(1/568 + S/517255)
	MFEFM	4197 + 0,687 x S	665,8 + 0,042 x S	1/(1/944 + S/418343)		MFHFM	4107 + 0,844 x S	659,8 + 0,051 x S	1/(1/734 + S/517255)
988-10	NEN	3264 + 0,975 x S	447,8 + 0,067 x S	1/(1/856 + S/675886)	988-10	NHN	3192 + 1,154 x S	441,8 + 0,08 x S	1/(1/774 + S/807126)
	MFEFM	5736 + 0,975 x S	1129 + 0,067 x S	1/(1/1229 + S/675886)		MFHFM	5620 + 1,154 x S	1120 + 0,08 x S	1/(1/1006 + S/807126)

Options

The order codes shown on the following tables indicate the bore size D1, or D2. This is standardly designed with the bore tolerance H7 with a keyway to DIN 6885-1 P9 and a set screw. In the case of the clamping hubs the order codes shown indicate the shaft diameter with tolerance h6. For additional options please refer to the required order codes in [section 3 of catalog MD 10.1](#).

Bore diameter metric in mm								
Bore diameter	Order code for bore diameter		Bore diameter	Order code for bore diameter		Bore diameter	Order code for bore diameter	
	ØD1 H7	ØD2 H7		ØD1 H7	ØD2 H7		ØD1 H7	ØD2 H7
6	L0A	M0A	60	L1E	M1E	190	L2C	M2C
7	L0B	M0B	65	L1F	M1F	195	L3F	M3F
8	L0C	M0C	70	L1G	M1G	200	L2D	M2D
9	L0D	M0D	75	L1H	M1H	210	L3G	M3G
10	L0E	M0E	80	L1J	M1J	220	L2E	M2E
11	L0F	M0F	85	L1K	M1K	230	L3H	M3H
12	L0G	M0G	90	L1L	M1L	240	L2F	M2F
14	L0H	M0H	95	L1M	M1M	250	L2G	M2G
16	L0J	M0J	100	L1N	M1N	260	L2H	M2H
18	L0K	M0K	105	L1P	M1P	270	L3J	M3J
19	L0L	M0L	110	L1Q	M1Q	280	L2J	M2J
20	L0M	M0M	115	L1R	M1R	290	L3K	M3K
22	L0N	M0N	120	L1S	M1S	300	L2K	M2K
24	L0P	M0P	125	L1T	M1T	320	L2L	M2L
25	L0Q	M0Q	130	L1U	M1U	340	L2M	M2M
28	L0R	M0R	135	L2X	M2X	360	L2N	M2N
30	L0S	M0S	140	L1V	M1V	380	L2P	M2P
32	L0T	M0T	145	L3A	M3A	400	L2Q	M2Q
35	L0U	M0U	150	L1W	M1W	420	L2R	M2R
38	L0V	M0V	155	L3B	M3B	440	L2S	M2S
40	L0W	M0W	160	L1X	M1X	450	L2T	M2T
42	L0X	M0X	165	L3C	M3C	460	L2U	M2U
45	L1A	M1A	170	L2A	M2A	480	L2V	M2V
48	L1B	M1B	175	L3D	M3D	500	L2W	M2W
50	L1C	M1C	180	L2B	M2B			
55	L1D	M1D	185	L3E	M3E			

Bore tolerance to DIN ISO 286								
Tolerance specification	Order code for specifying bore tolerance		Tolerance specification	Order code for specifying bore tolerance		Tolerance specification	Order code for specifying bore tolerance	
	ØD1	ØD2		ØD1	ØD2		ØD1	ØD2
H7	L10	M10	N7	L15	M15	J6	L24	M24
F7	L11	M11	P7	L16	M16	K6	L25	M25
J7	L12	M12	E7	L18	M18	M6	L26	M26
K7	L13	M13	F6	L21	M21	N6	L27	M27
M7	L14	M14	H6	L22	M22	P6	L28	M28
G7	L17	M17	G6	L23	M23			



BORE SPECIFICATIONS

Bore diameter imperial in inches								
Bore diameter	Order code for bore diameter		Bore diameter	Order code for bore diameter		Bore diameter	Order code for bore diameter	
	ØD1 H7	ØD2 H7		ØD1 H7	ØD2 H7		ØD1 H7	ØD2 H7
0,1875	L5A	M5A	2,1875	L6K	M6K	4,1875	L7T	M7T
0,25	L5B	M5B	2,25	L6L	M6L	4,25	L7U	M7U
0,3125	L5C	M5C	2,3125	L6M	M6M	4,375	L7V	M7V
0,375	L5D	M5D	2,375	L6N	M6N	4,4375	L7W	M7W
0,5	L5E	M5E	2,4375	L6P	M6P	4,5	L7X	M7X
0,5625	L5F	M5F	2,5	L6Q	M6Q	4,75	L8A	M8A
0,625	L5G	M5G	2,5625	L6R	M6R	4,875	L8B	M8B
0,6875	L5H	M5H	2,625	L6S	M6S	4,9375	L8C	M8C
0,75	L5J	M5J	2,6875	L6T	M6T	5	L8D	M8D
0,8125	L5K	M5K	2,75	L6U	M6U	5,1875	L8E	M8E
0,875	L5L	M5L	2,8125	L6V	M6V	5,25	L8F	M8F
0,9375	L5M	M5M	2,875	L6W	M6W	5,4375	L8G	M8G
1	L5N	M5N	2,9375	L6X	M6X	5,5	L8H	M8H
1,0625	L5P	M5P	3	L7A	M7A	5,75	L8J	M8J
1,125	L5Q	M5Q	3,0625	L7B	M7B	5,9375	L8K	M8K
1,1875	L5R	M5R	3,125	L7C	M7C	6	L8L	M8L
1,25	L5S	M5S	3,1875	L7D	M7D	6,25	L8M	M8M
1,3125	L5T	M5T	3,25	L7E	M7E	6,5	L8N	M8N
1,375	L5U	M5U	3,3125	L7F	M7F	6,75	L8P	M8P
1,4375	L5V	M5V	3,375	L7G	M7G	7	L8Q	M8Q
1,5	L5W	M5W	3,4375	L7H	M7H	7,25	L8R	M8R
1,5625	L5X	M5X	3,5	L7J	M7J	7,5	L8S	M8S
1,625	L6A	M6A	3,5625	L7K	M7K	7,75	L8T	M8T
1,6875	L6B	M6B	3,625	L7L	M7L	8	L8U	M8U
1,75	L6C	M6C	3,6875	L7M	M7M	9	L8V	M8V
1,8125	L6D	M6D	3,75	L7N	M7N	10	L8W	M8W
1,875	L6E	M6E	3,8125	L7P	M7P	11	L8X	M8X
1,9375	L6F	M6F	3,875	L7Q	M7Q	12	L9A	M9A
2	L6G	M6G	3,9375	L7R	M7R	13	L9B	M9B
2,0625	L6H	M6H	4	L7S	M7S	14	L9C	M9C
2,125	L6J	M6J	4,125	L9E	M9E	15	L9D	M9D

