

L-force

PC-based Automation



reliable, productive automation

Our commitment to you

If you are looking for effective and easy solutions for the implementation of your machine and drive concepts or want to optimise existing concepts and cut your costs, Lenze is your ideal partner.

We have more than 60 years' experience at the cutting edge of drive and automation technology.



Drive and automation technology from Lenze keep things moving – for example in the areas of materials handling, robotics and component handling as well as in packaging facilities for the intralogistics and automotive sectors and the food and beverage industries.

Lenze | about us

We can offer you automation solutions, including control, visualisation and drive technology, from one source. Our drive systems will improve the performance of your machines. From project planning to commissioning, we have the know-how. Our international sales and service network can provide you with expert help and advice at any time.

Cut your process costs and increase your ability to compete. Let us analyse your drive technology tasks and support you with made-to-measure solutions.

We can take an integrated approach to projects thanks to the scalability of our products and the scope of the overall portfolio. We can get the best from your machines and systems.

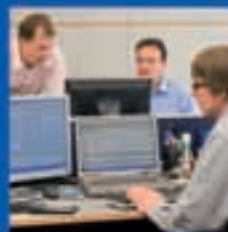

At your side all over the world – with thorough and professional support from our motivated team.

Lenze | Your future is our drive

L-force – Your future is our drive

In order to cut your costs, save you time and increase your efficiency, through L-force we have made a unique product philosophy reality. This generation of drive and automation technology perfectly combines innovation, flexibility, usability and a systematic approach.

L-force is innovation

Every day we are working on better solutions to offer you more options and (added) value.

L-force is flexibility

Performance, functional range, software and service – we deliver just the right combination.

L-force is usability

Prepared solutions and simple and function-focused engineering simplify commissioning for you.

L-force is systematic

Everything about L-force is perfectly coordinated.

Let's shape the future together.

L-force is an integrated program of components, solutions, systems and services. This overview shows our full range with individual product and solution segments.

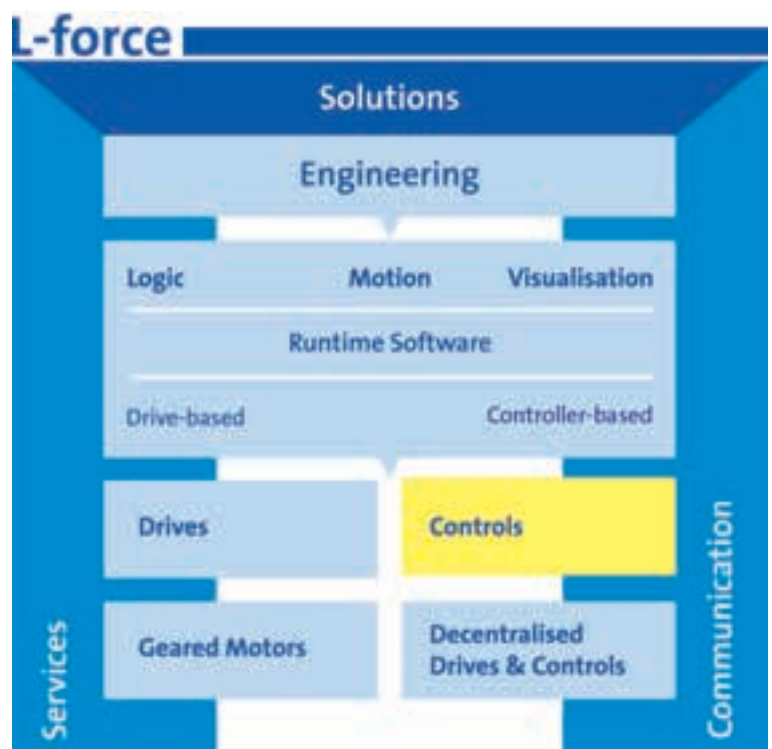

Automation | Tailor-made solutions

Are you looking for...

- ▶ a strong technology partner for drive and automation technology?
- ▶ a more efficient way of engineering the electrical parts of your machines?
- ▶ compliance with open standards?
- ▶ tried-and-tested solutions you can rely on for complex drive tasks?
- ▶ ways of implementing tailor-made solutions for a wide range of industry sectors and applications, quickly and cost-effectively?

...and how do you benefit?

- ▶ optimised support from a reliable technology partner
- ▶ complete product range covering all aspects of drive and automation technology
- ▶ reliable and powerful products
- ▶ improved availability through a reduction in individual components
- ▶ coordinated components ensure greater security in your system
- ▶ tailor-made solutions for a wide range of industry sectors and applications

...then you can rely on drive and automation technology from Lenze

- ▶ logic based on IEC 61131-3
- ▶ motion based on PLCopen Part 1+2
- ▶ centralised PC-based solutions
- ▶ operation and monitoring in close proximity to the machine right through to the SCADA system, integrated with VisiWinNET®

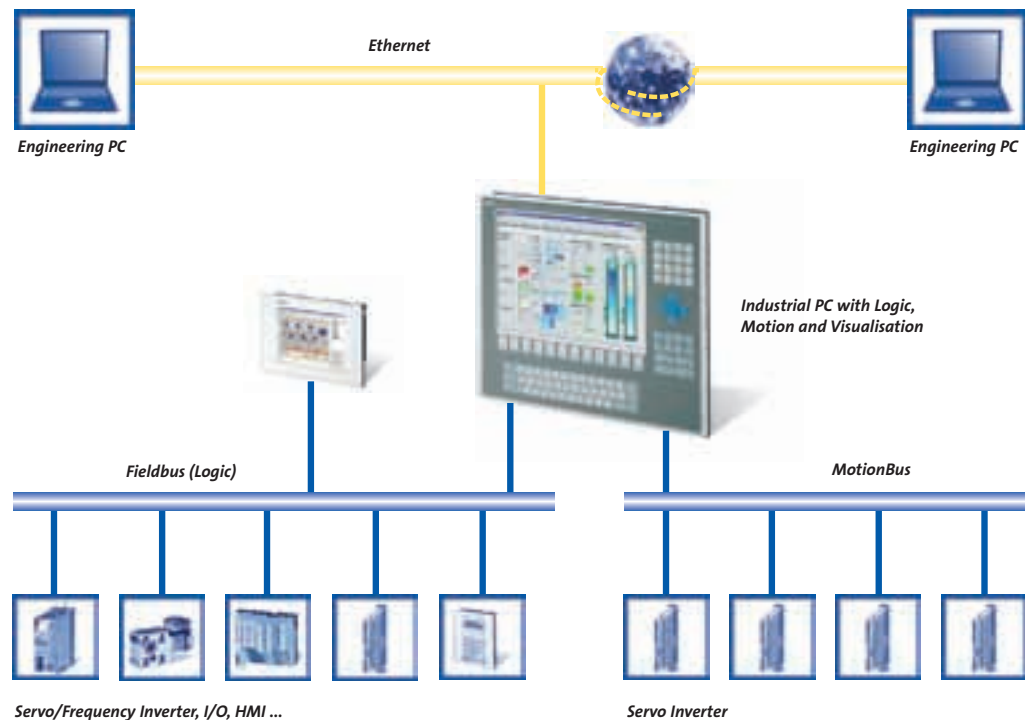

Systematic | Drive and automation technology

Cutting-edge products and complete drive and automation solutions for mechanical and systems engineering – that is what Lenze stands for. We deliver the solutions that customers really need for their applications.

Building on distributed and centralised automation architectures, we offer our customers integrated and comprehensive control technology, from intelligent servo controllers and motion controllers through to PC-based systems.

The control technology segment is complemented by a broad range of visualisation products, from conventional operating and display units to PC solutions. Finally, the range of I/O systems offers two useful product concepts.

In the drive technology sector we offer our customers frequency and servo inverters with power ratings up to 400 kW. This means that we can support both centralised control cabinet solutions and distributed drive concepts, such as motor inverters with IP65 protection. Corresponding to the various inverters we offer both standard three-phase AC motors and synchronous and asynchronous servo motors, all of which can be combined with a variety of gearbox designs.

We have extensive applications expertise from many different industry sectors. This knowledge and the experience we gain from ongoing discussions with our customers is channelled back into the specification of our products and systems.

We also offer a comprehensive customer support service, including advice on developing your automation solution, training courses, help with commissioning your system, a worldwide helpline, and our own systems engineering facility.

Overview | Our product range



Controls and industrial PCs



Software, I/O and visualisation



Frequency inverters



Servo inverters



Decentralised drive technology



Standard three-phase AC motors, synchronous and asynchronous servo motors



Gearboxes and geared motors

Automation | Solution portfolio

Our modular system platform, comprising hardware and software elements, allows us to implement tailor-made solutions for a wide variety of industry sectors and applications, quickly and cost-effectively.

Control technology

Intelligent machine controls

Controls are regarded as the key element of automation solutions. Whether you are looking for a distributed or centralised control concept – you will find the right solution at Lenze. From small control systems to industrial PCs with SoftMotion and visualisation, we have everything you need to automate your machines.

No matter which solution you choose, the programming will be based on standards such as IEC 61131-3 and PLCopen.



Visualisation

From the HMI to the SCADA system

Visualisation systems represent the interface between people and machines – from simple text display and high-resolution touch panels to the SCADA system.

For more demanding requirements we offer the .NET-based VisiWinNET®, a modular and scalable visualisation system covering our entire range of solutions, from HMIs with Windows® CE through to industrial PCs with distributed command stations.

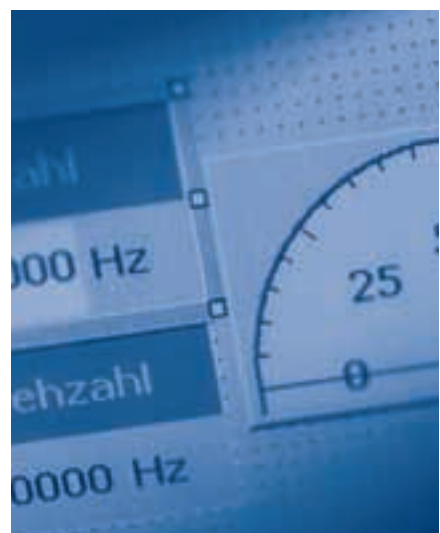

Industrial PC

The hardware basis for automation

Industrial PCs have become an indispensable part of the world of automation. Rugged and cost-effective hardware, universal software and protocol standards and modern operating systems with real-time capability lay the foundations for the productive integration of PC technology into an ever-increasing range of industrial applications.

Based on a rigorously implemented platform strategy, the product range covers industrial PCs, rugged IP65 operating panels and thin-client solutions as well as comprehensive PC-based automation systems.



I/O system

Compact and clever

The degree of automation of machines and installations is growing all the time, and the increasing numbers of peripherals mean that wiring requirements are escalating.

Decentralised I/O systems can help you regain control.

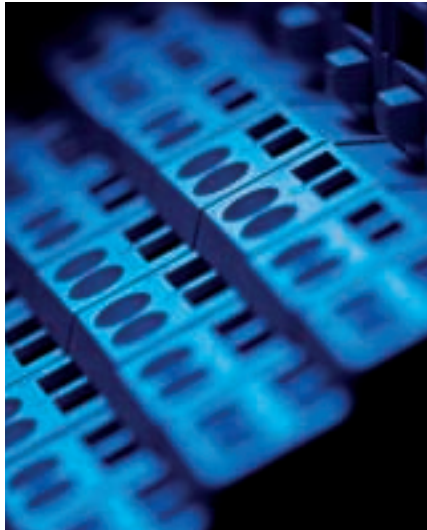

Logic

IEC 61131-3

PLCopen

Motion

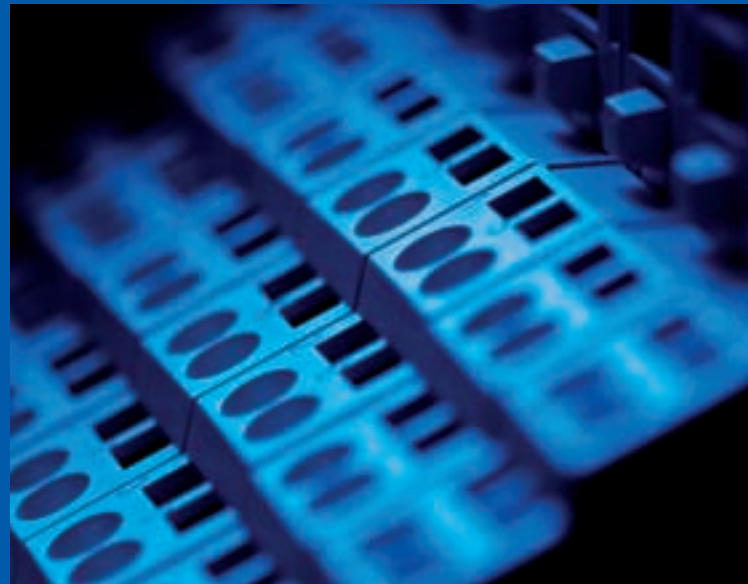
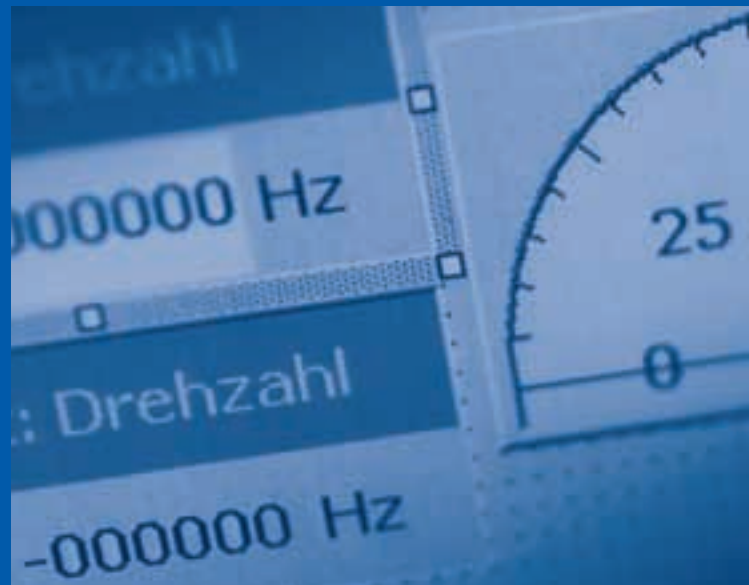

Contents | Automation solutions

Control technology

1

Visualisation

2

Industrial PC

3

I/O system

4

Logic

IEC 61131-3

PLCopen

Motion

Control technology

Intelligent machine controls

Introduction _____ 1-2

PC-based Automation _____ 1-5

System overview

Products

Communication

Engineering _____ 1-9

PLC Designer

Web-based parameter setting

Backup & Restore

VisiWinNET®

Engineer

Overview of control technology _____ 1-11

Architectures

In control technology a fundamental distinction is made between PC-/controller-based and drive-based architectures. The latter are mainly used for distributed or highly modular systems. Machine modules with a relatively small number of axes and with strictly limited functions, which can be influenced by very few external signals, can operate entirely autonomously in this way and require no separate control system. In such cases the drive contains both the motor control and all other control functions, including motion control and logic.

By contrast, the control function for a PC-/controller-based architecture is located in a higher-level centralised unit. In this case the motion control function can be located either in the drive or in the control system.

The most suitable location for the motion control function depends on the motion control method used. In the case of coordinated movements the function must always be located in the controller, whereas for synchronised movements either option is both conceivable and reasonable, and both are commonly found in practice.

There is very little difference between controller- and PC-based automation architectures in terms of structure. Whereas with a PC-based system the visualisation runs on the same hardware as that used for the control function, for a controller-based system it is often located in a separate visualisation unit. However, when it comes to the actual control task the difference is irrelevant, so the two architectures are covered together in the following section.

Regardless of the form of motion control required by your application or the automation architecture you prefer, you will find that Lenze has the right solution for every task.

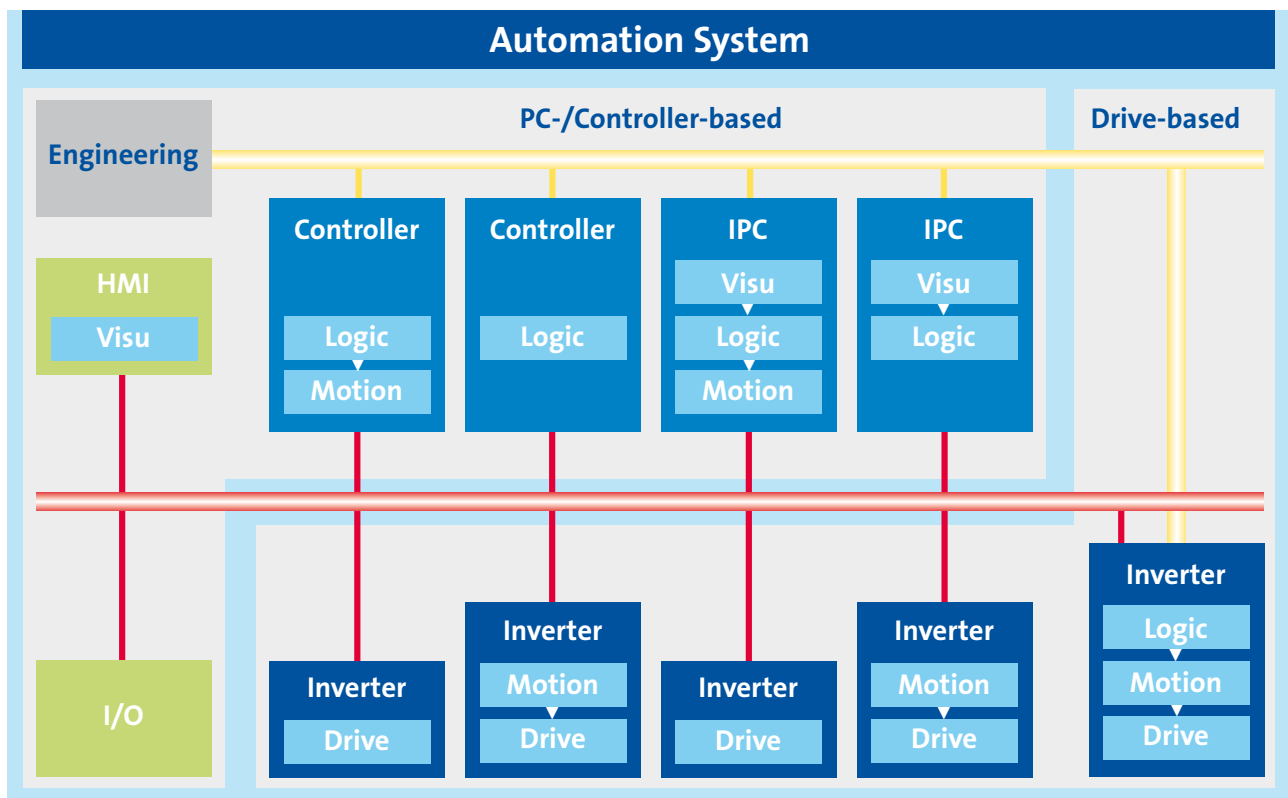

Number of axes

An important criterion when it comes to selecting the automation architecture is the number of axes. While the drive-based approach is very suitable in cases where the number of axes is limited, a centralised topology offers clear advantages once the number of axes reaches about 6 or more.

Where the number of axes is greater than 10, it is common to find hybrid forms using a mix of drive- and PC-/controller-based automation, which combine the advantages of strictly limited and self-contained machine modules with a centralised control concept.

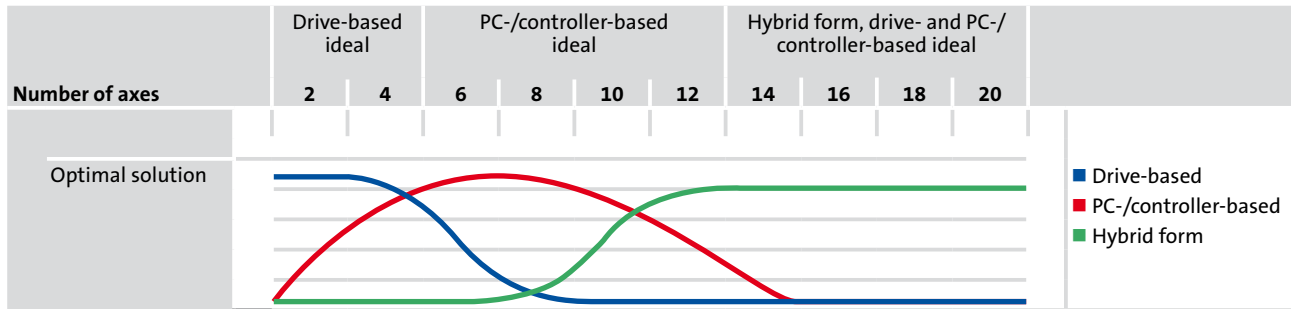

Motion control

Another criterion influencing the choice of automation architecture is the method of motion control.

► Independent motion tasks

Independent motion tasks can be executed without a close temporal association with other axes. Examples include speed control systems, for tool drives for example, and point-to-point positioning systems. Tasks like these are common in many materials handling applications. This type of requirement can be implemented very effectively within the drive system.

► Synchronised motion tasks

In synchronised motion tasks a derived movement follows a master movement. The master movement is not directly influenced by the derived movements. Typical tasks include electrical shafts, winding, and cam applications. This type of motion task is commonly found in continuous production processes and in cyclic production machines. Both forms of architecture are possible in such cases.

► Coordinated movements

Coordinated movements control multiple axes synchronously with one another. These tend to be multi-dimensional path movements such as those found in machine tools and robots. This is clearly an area for PC-/controller-based automation.

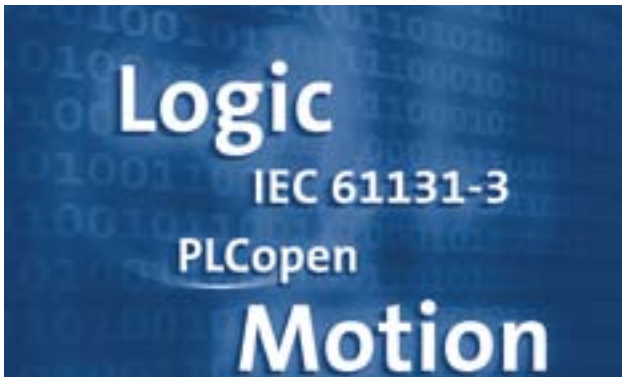

Movement type	Independent movements	Synchronised movements	Coordinated movements	
	Movement is independent of other axes ► Speed control ► Point-to-point positioning	Movement of one axis is synchronised with a master movement ► Electrical shafts ► Winding ► Cams	Multiple axes move synchronously with one another ► Multi-dimensional path movements	
Applications	► Conveyor belts ► Materials handling systems (e.g. storage and retrieval units, gantry systems)	► Continuous production processes ► Cyclic production machines	► Machine tools ► Robots	
Ideal implementation method	Implementation in drive (drive-based)			Implementation in central control unit (PC-/controller-based)

Runtime software



The control functionalities are described via the runtime software. Alongside the various classes, scaling also exists within the runtime environments, so you only need to pay for those functionalities you actually need. The performance data for the individual software versions can be determined only in combination with the chosen hardware platform.

1

Runtime software	Versions available
 <p>L-force Logic</p>	<p>LPC 1000</p> <ul style="list-style-type: none"> ▶ PLC functionality in accordance with IEC 61131-3 ▶ 6 languages: <ul style="list-style-type: none"> – Instruction list (IL) – Ladder diagram (LD) – Function block diagram (FBD) – Structured text (ST) – Sequential function chart (SFC) – Continuous function chart (CFC) ▶ Multitasking ▶ Based on the tried-and-tested CoDeSys
 <p>L-force Motion</p>	<p>MPC 1200</p> <ul style="list-style-type: none"> ▶ Motion based on PLCopen Part 1 + 2 ▶ NC in accordance with 3 interpolated axes (3 D) ▶ NC transformations: gantry, tripod and Scara via libraries ▶ G-code interpreter module (DIN 66025) ▶ Electronic cam ▶ Electronic cam group <p>This software is only supplied together with L-force Logic</p>
 <p>L-force Visu</p>	<p>VisiWinNET®</p> <ul style="list-style-type: none"> ▶ VisiWinNET® Compact CE ▶ Operating system-dependent runtime software, installed on the destination hardware ▶ Scaling via the number of power tags

PC-based Automation

A comprehensive range of hardware platforms, runtime environments and accessories is available in the area of PC-based automation.

- ▶ Based on industrial PCs with Windows® CE
- ▶ Choice of designs
- ▶ Performance capability of the control technology is dependent on the performance of the individual hardware platform
- ▶ Scaling of the functional range via runtime software
- ▶ Can be combined with the VisiWinNET® visualisation system on the same hardware

Features of PC-based automation

- ▶ Industrial PC as a gateway for data exchange between the engineering PC and the field devices (depending on the bus system)
- ▶ Backup and restore mechanisms via USB flash drive
- ▶ Logbook of errors and messages

Depending on the application area, the first step is to decide on the hardware platform on which your control system will run. Then you can configure the appropriate hardware and software for your control PC.

The multitasking and real-time capabilities of Windows® CE ensure a balanced and deterministic distribution of computing time between the control system and the other applications. The high degree of accuracy of the system means that even highly dynamic processes can be controlled.

Programming is carried out using the tried-and-tested PLC Designer V2.x, which is supplied free of charge with every industrial PC.

Field devices supported



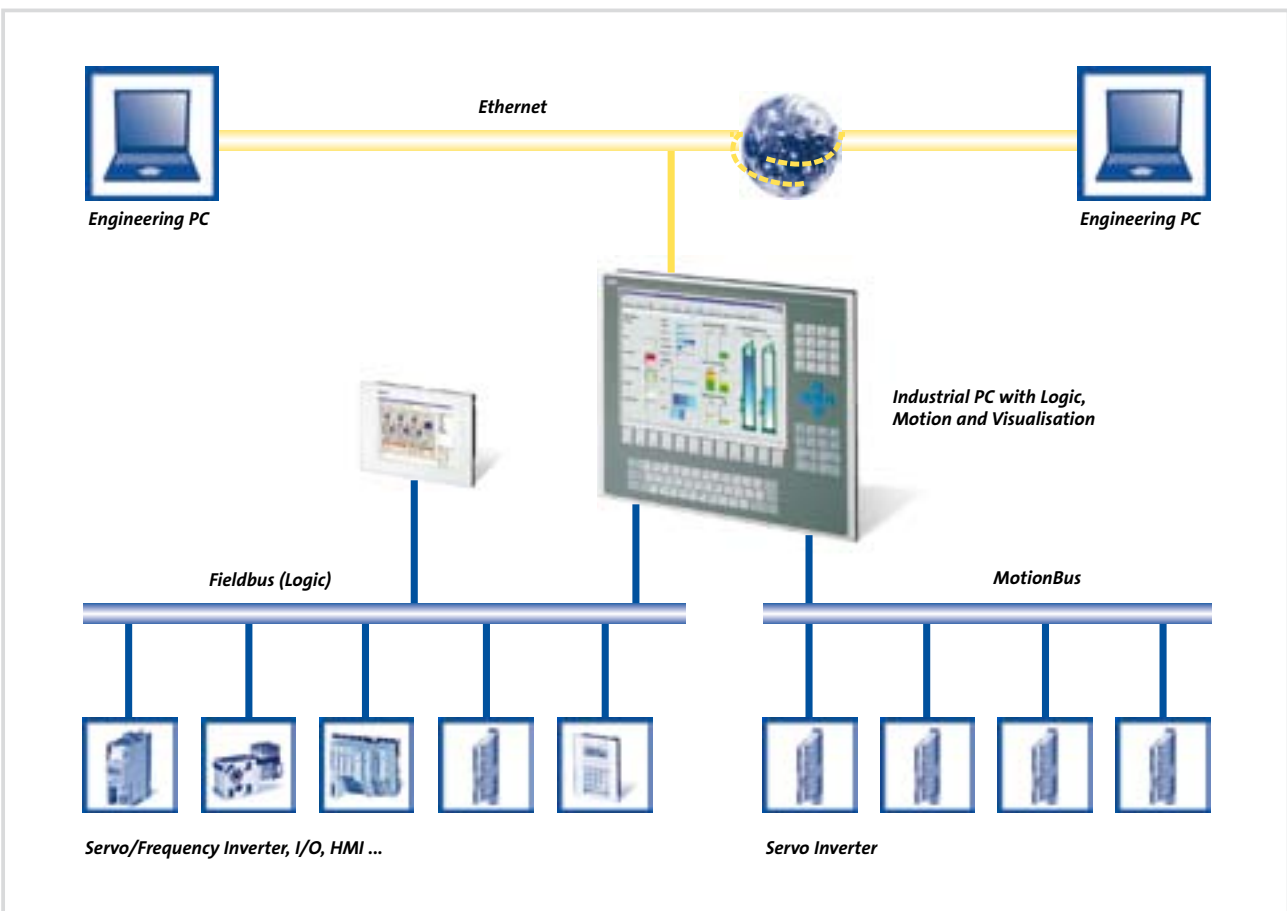

- ▶ Servo Drives 9400
- ▶ ECS servo system
- ▶ Inverter Drives 8400
- ▶ I/O system IP20
- ▶ I/O system 1000

Other field devices can be integrated via the device description file.



Products

1

HMI with Windows® CE		Versions available
	Embedded Line	<p>EL 100 PLC (EL 103 ECO, EL 105m – EL110)</p> <ul style="list-style-type: none"> ▶ 8.9 cm (3.5") to 26.4 cm (10.4") ▶ Integrated CAN interface ▶ Ethernet on board ▶ For L-force Logic (LPC 1000) ▶ For L-force Visu (VisiWinNET® Compact CE Runtime)
Industrial PC systems		Versions available
	Embedded Line	<p>EL 1800 – EL 9800</p> <ul style="list-style-type: none"> ▶ 26.4 cm (10.4") to 48.3 cm (19") ▶ Various front/keyboard versions ▶ Interfaces: <ul style="list-style-type: none"> – 2-way CAN (1 x Logic, 1 x Motion) – 4-way CAN (1 x Logic, 3 x Motion) – 1-way PROFIBUS (Logic) ▶ Ethernet on board ▶ For L-force Logic (LPC 1000) ▶ For L-force Motion (MPC 1200) ▶ For L-force Visu (VisiWinNET® Compact CE Runtime)
	Command Station	<p>CS 5800 – CS 9800</p> <ul style="list-style-type: none"> ▶ 38.1 cm (15") to 48.3 cm (19") ▶ Various front/keyboard versions <ul style="list-style-type: none"> – stand-alone, all-round IP65 protection – flexible support arm mounting ▶ Interfaces: <ul style="list-style-type: none"> – 2-way CAN (1 x Logic, 1 x Motion) – 1-way PROFIBUS (Logic) ▶ Ethernet on board ▶ For L-force Logic (LPC 1000) ▶ For L-force Motion (MPC 1200) ▶ For L-force Visu (VisiWinNET® Compact CE Runtime)
	Control cabinet PC	<p>CPC 2800</p> <ul style="list-style-type: none"> ▶ Control cabinet mounting ▶ Monitor panel available as screen <ul style="list-style-type: none"> – MP DVI (Embedded Line design) – CS DVI (Command Station design) ▶ Interfaces: <ul style="list-style-type: none"> – 2-way CAN (1 x Logic, 1 x Motion) – 4-way CAN (1 x Logic, 3 x Motion) – 1-way PROFIBUS (Logic) ▶ Ethernet on board ▶ For L-force Logic (LPC 1000) ▶ For L-force Motion (MPC 1200) ▶ For L-force Visu (VisiWinNET® Compact CE Runtime)

For detailed hardware system features of these industrial PCs, please refer to chapter 2 "Visualisation" or chapter 3 "Industrial PC"

PC-based automation with CANopen

CANopen

- ▶ Separation of motion and logic bus
- ▶ Up to 4 synchronised motion buses possible
- ▶ Cost-effective solution for average performance with limited number of axes
- ▶ 1 ms cycle time
- ▶ Industrial PC as a gateway for data exchange between engineering PC and field devices

Up to 4 CAN buses

A maximum of 3 drive controllers can be operated synchronously on one CAN bus at a baud rate of 1 MBit/s with a cycle time of 1 ms. For that reason there are a number of CAN buses available which are suitable for motion applications and which are synchronised with one another. The number of addressable drive controllers therefore increases with the number of bus lines.

The use of a separate CAN bus for pure logic control always makes sense, as this avoids any disruption to a drive controller by another CANopen node (e.g. an HMI).

CANopen or system bus (CAN)

The Lenze 8200 vector, 9300 and ECS device ranges feature an on-board system bus (CAN) connection. The protocol used here represents a subset of CANopen. So although the devices are not compliant with CANopen, they can still be operated under L-force controls on a CANopen-compatible control system, with other CANopen-compatible nodes if required.

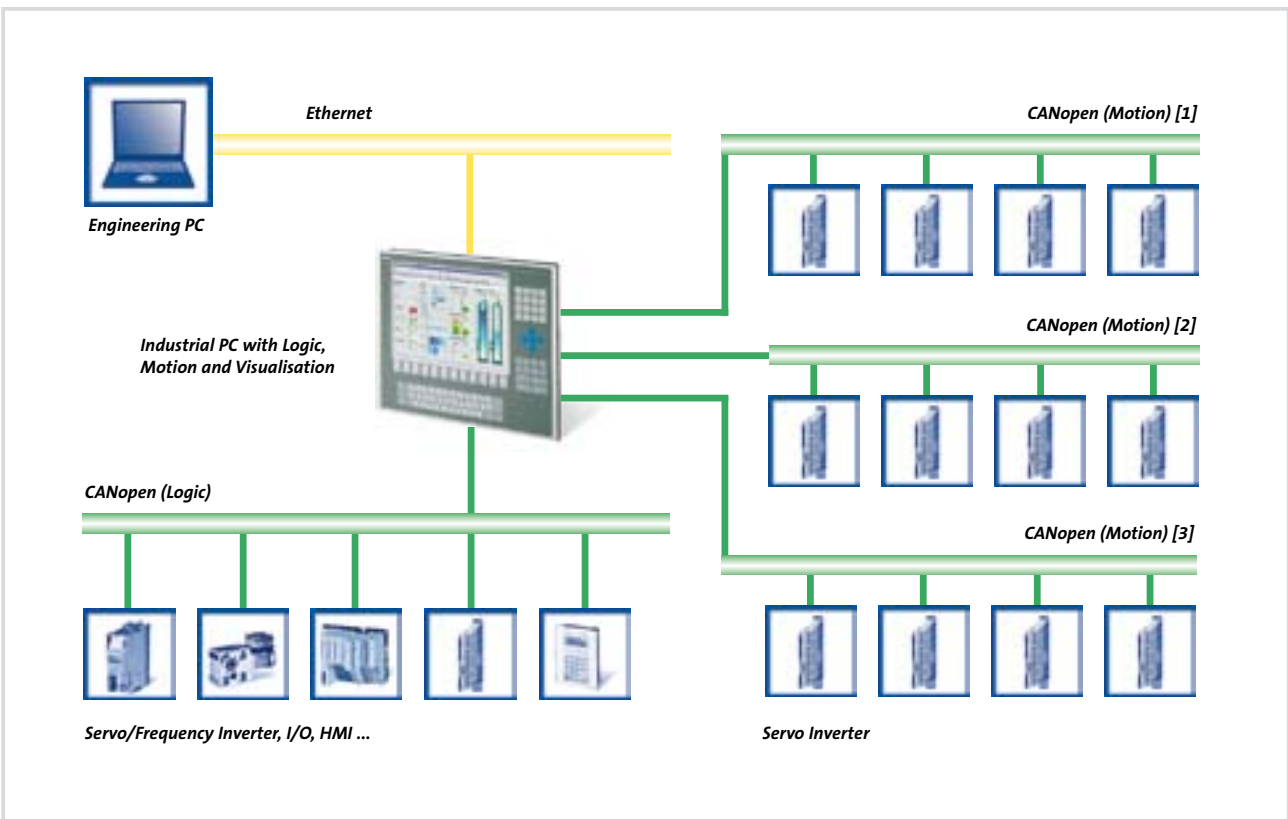
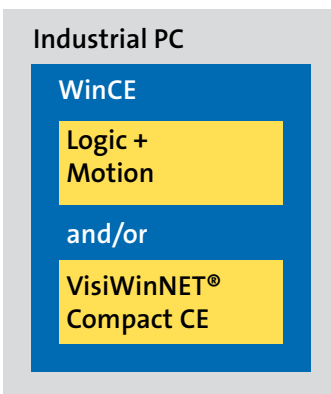

PC-based automation with PROFIBUS



- ▶ Soft PLC with L-force Logic (LPC1000) functional range
- ▶ Can be combined with motion buses
- ▶ Integration of devices using DDF (device description file)

Tried-and-tested technology

PROFIBUS is the most widely used fieldbus in today's automation technology industry. The choice of available field devices is immense. The expansion of control technology to include PROFIBUS means that this diversity is now also available within L-force Logic.

Possible combinations

To allow tried-and-tested PROFIBUS-automated system components to be integrated into the Lenze control world and at the same time to benefit from the advantages of PC-based automation, Lenze offers a number of possible combinations. For instance, the logic field devices can be addressed via PROFIBUS, while up to 2 CAN buses can be operated in parallel as a motion bus (not with Command Station). This also ensures a smooth transition when switching from PROFIBUS to other bus systems.

Industrial PC

WinCE

Logic

and/or

VisiWinNET®
Compact CE



Engineering PC

Ethernet



Industrial PC with Logic,
Motion and Visualisation

PROFIBUS



Servo/Frequency Inverter, I/O, HMI, etc.

Engineering

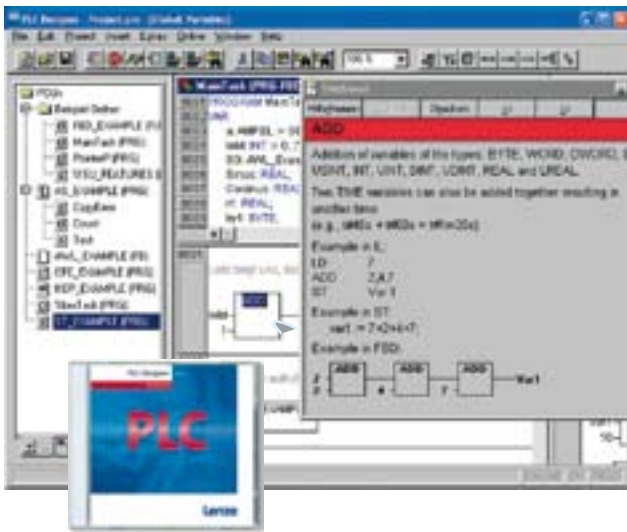

PLC Designer

Lenze uses PLC Designer as its central engineering software for control technology. This is based on the familiar CoDeSys and offers the following features:

- ▶ Programming of Logic & Motion in accordance with IEC 61131-3 (IL, LD, FBD, ST, SFC and CFC editor)
- ▶ Certified function blocks in accordance with PLCopen Part 1 + 2
- ▶ NC component library
- ▶ Graphical DIN 66025 editor (G-Code) with DXF import
- ▶ Cam editor

PLC Designer is bundled with every industrial PC and every HMI with Windows® CE which has been configured for use for L-force Logic & Motion. It can also be downloaded free of charge from the download area on the Internet.

www.Lenze.com



Web-based parameter setting

All industrial PCs from the area of PC-based automation have an integrated web server with pre-prepared pages for the following actions:

- ▶ Configuration and diagnostics of IPCs
- ▶ Access to all IPC parameters
- ▶ Access to integrated IPC logbook

All major commissioning and diagnostics work can therefore be undertaken without a separate PC program; all that is required is a web browser.

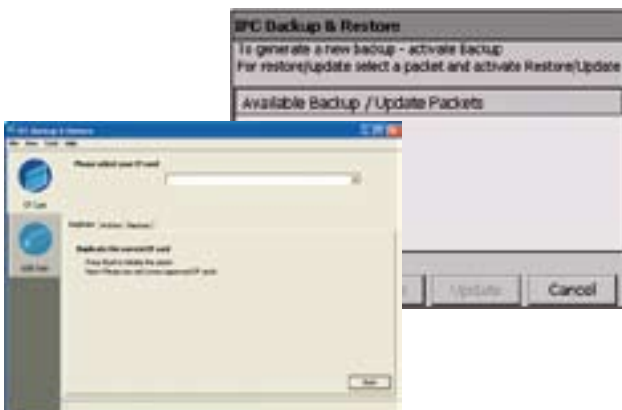

Backup & Restore

Backup & Restore is a free, easy-to-use software application for backing up the data on your industrial PCs:

- ▶ Preparing a USB flash drive in order to perform backup or restore operations on the IPC
- ▶ Loading updates onto a CF card
- ▶ Formatting
- ▶ Creating a bootable CF card
- ▶ Copying CF cards
- ▶ Archiving a CF card on the PC and restoring the CF card

You will find Backup & Restore on the CD that is supplied with every industrial PC. Suitable USB flash drives can be found on page 3-49.



VisiWinNET®

VisiWinNET® is a complete, integrated visualisation software platform for mechanical and systems engineering which can be used to create visualisation applications for a very wide range of applications. The strength of VisiWinNET® lies in its scalability and in the fact that it combines a runtime and developer system.

The following versions are available for use with L-force Logic & Motion:

- ▶ VisiWinNET® Compact CE runtime
- ▶ VisiWinNET® Smart development package (graphical):
 - simple applications
 - full-graphics integrated development environment
- ▶ VisiWinNET® Professional development package (Visual Studio .NET)
 - fully integrated into "Visual Studio .NET"
 - programming in "VB .NET" and "C#"
 - free programming (e.g. database access)

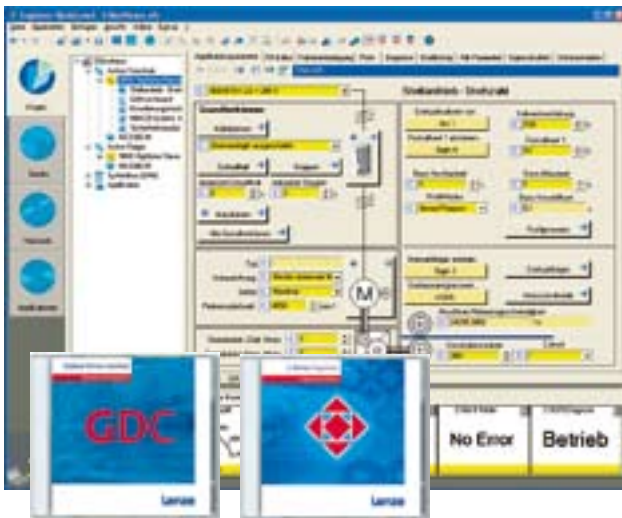

Engineer

The Engineer can be used for parameter setting, configuration and diagnostics of drive controllers. It can also be used for parameter setting of industrial PCs if required.





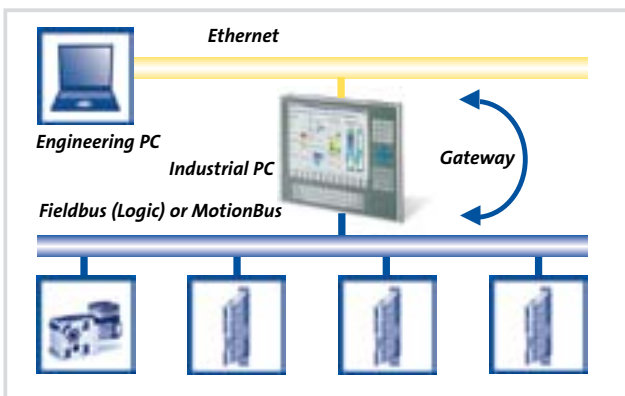



Global Drive Control (GDC)

GDC can be used for parameter setting for older-generation drive controllers.



In combination with the gateway function on the IPC it is also possible to access field devices located on a bus below the IPC (apart from PROFIBUS). This eliminates the need for direct access to the CAN bus, for example, with a special bus interface.

System overview

Control system		Control technology				Field devices			
System components	Hardware	HMI	Industrial PC		I/O systems	Servo inverters		Frequency inverter	
		with Windows® CE	Embedded Line	Command Station		Control cabinet PC			
	Device range								
		EL 100 PLC	EL 1800 - 9800	CS 5800 - 9800	CPC 2800	I/O system 1000	9400 Servo Drives	ECS servo system	Inverter Drives 8400
Software									
Runtime software									
L-force Visu									
	VisiWinNET® Compact CE	●	●	●	●				
L-force Logic									
	LPC 1000	●	●	●	●	●	●	●	●
L-force Motion									
	MPC 1200		●	●	●		●	●	
Engineering									
	PLC Designer	●	●	●	●				
	Web-based parameter setting		●	●	●				
	Backup & Restore		●	●	●				
Visualisation									
	VisiWinNET® Smart	●	●	●	●				
	VisiWinNET® Professional	●	●	●	●				
	Engineer		●	●	●	●	●		●
	Global Drive Control (GDC)							●	
Communication									
	CANopen	●	●	●	●	●	●	●	●
	PROFIBUS		●	●	●	●	● ¹⁾	● ¹⁾	●

¹⁾ Only as a node of L-force Logic

Drehzahl

000000 Hz

Drehzahl

0000000 Hz



Visualisation

From text display and touchscreen through to SCADA system

HMI and industrial PCs

Introduction	2-2
Visualisation systems	2-5
System overview	
Products	
System architectures	2-7
HMI with Windows® CE	2-11
Order data	
VisiWinNET® runtime software	2-15
Order data	
VisiWinNET® engineering software	2-16
Features	
Tools	
Order data	
HMI series EPM-H	2-21
Designs	
Visualisation software	
Rated data	
Accessories	
Overview of visualisation technology	2-28

Architectures

As the complexity of machines continues to grow, object-oriented systems for process visualisation are now an indispensable part of many installations.

Visualisation or Human Machine Interface (HMI) is the interface between people and machines, from simple text display and high-resolution touchscreens to the SCADA system. We can offer a comprehensive, graded range of products to suit every requirement.

Tailor-made runtime systems

Visualisation applications handle these tasks. The range of requirements covered by these systems is just as varied as the installations themselves. It extends from HMIs located in close proximity to the machines, via control and monitoring, through to complex SCADA systems with the various stations operating as client or viewer. Runtime systems are used on industrial PCs or on HMIs with Windows® CE.

Openness

The runtime systems of L-force Visu finally remove the barriers imposed by proprietary visualisation systems. Drawing on innovative technologies, the L-force Visu runtime systems offer a uniform, integrated visualisation software platform for mechanical and systems engineering. From the simple label field through to the complex display of trends, the VisiWinNET® visualisation system provides all the key elements to facilitate simple interface design as component packages. These templates and ready-made examples allow applications to be created quickly and efficiently. In addition, custom functions can be added to the system via the object-oriented .NET system environment.

Tried-and-tested systems for simple tasks

The HMI series EPM-H offers a choice between text, graphics, a simple touch display or a hand-held display. These operating and display devices can be programmed within an integrated development environment, the HMI Designer, and individually configured for their specific applications.

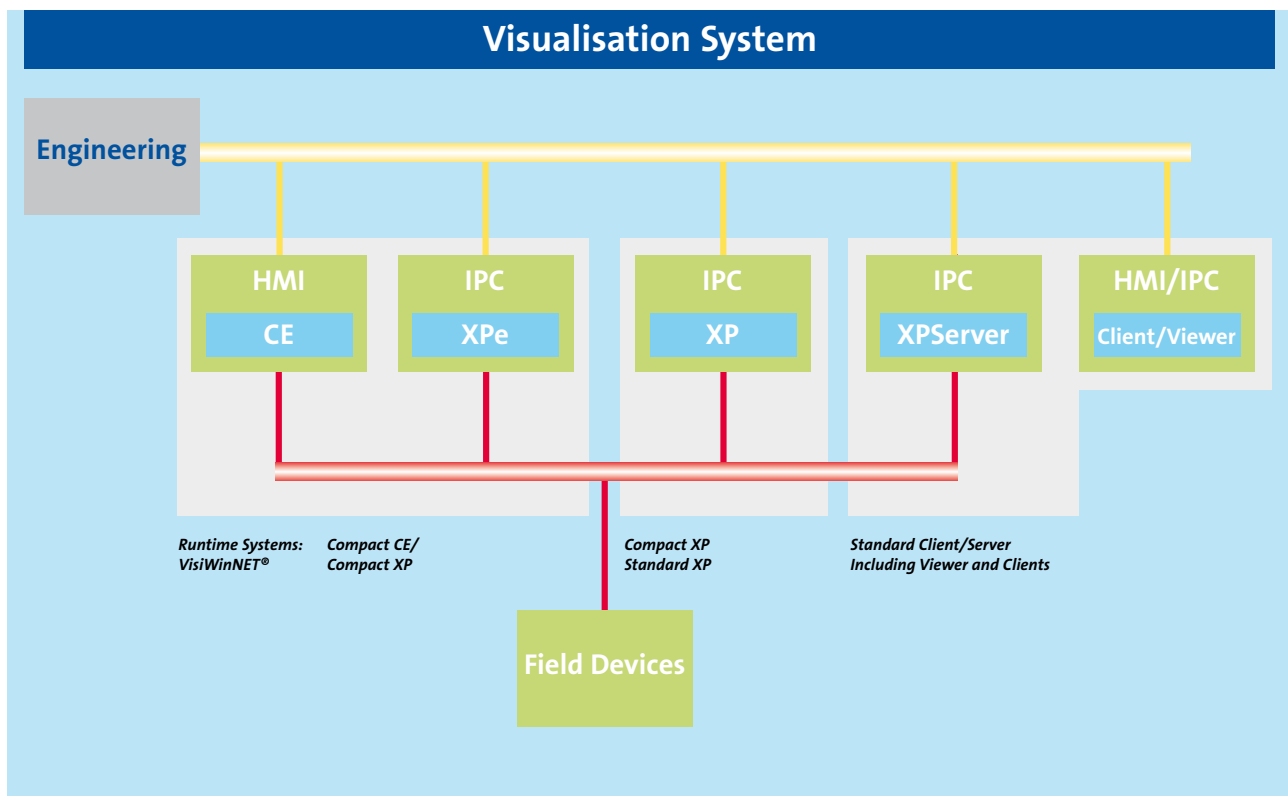



Process visualisation systems

Visualisation systems	Features/Notes
<p>The diagram shows a monitor and a server rack connected to a horizontal line labeled 'Fieldbus'. From this line, four vertical lines connect to four separate icons representing fieldbus devices.</p>	<p>Single-location solution</p> <p>In a single-location application the visualisation IPC communicates directly with a control system or with the lower-level fieldbus devices.</p>
<p>The diagram shows a monitor connected to a horizontal line labeled 'Fieldbus'. From this line, four vertical lines connect to four separate icons representing fieldbus devices.</p>	<p>Control system</p> <p>Visualisation directly on the control IPC with a connection to the L-force Logic & Motion</p> <p>→ Chapter 1: Control technology</p>
<p>The diagram shows two monitors connected to a horizontal line labeled 'Ethernet'. This line connects to a server rack. Below the server rack is a horizontal line labeled 'Fieldbus', which is connected to four separate icons representing fieldbus devices.</p>	<p>Client/server solution</p> <p>The client/server system is a classical SCADA application (Supervisory Control and Data Acquisition). Typical of this application is a central PC (server) for data management (alarm system, recipe control, trend management).</p> <p>Operation and monitoring of the machine or installation takes place via distributed client devices.</p>

Runtime software



All visualisation applications are executed within a runtime environment. The licence required for this purpose depends on the operating system of the destination hardware.

The licensing of the runtime systems can be handled by means of a dongle for the USB interface or a licence file associated with the MAC address of the network interface card.

2

VisiWinNET® Compact

VisiWinNET® Compact CE / Compact XP
Runtime system for Windows® CE, Windows® XP and Windows® Embedded Standard 2009.
The runtime software requires very little memory capacity and is intended specifically for systems with limited processor power. A typical application area is operation and monitoring in close proximity to the machine.

VisiWinNET® Standard

- ▶ VisiWinNET® Standard XP
Runtime system for Windows® XP or Windows® Embedded Standard 2009 for applications requiring a medium to high performance level.
- ▶ VisiWinNET® Standard Client/Server (C/S)
Runtime system for Windows® XP as a client/server system. It offers the full range of functions of VisiWinNET® Standard, but all common information is administered centrally on a server.
Simple workstations function as clients under Windows® CE or Windows® XP.

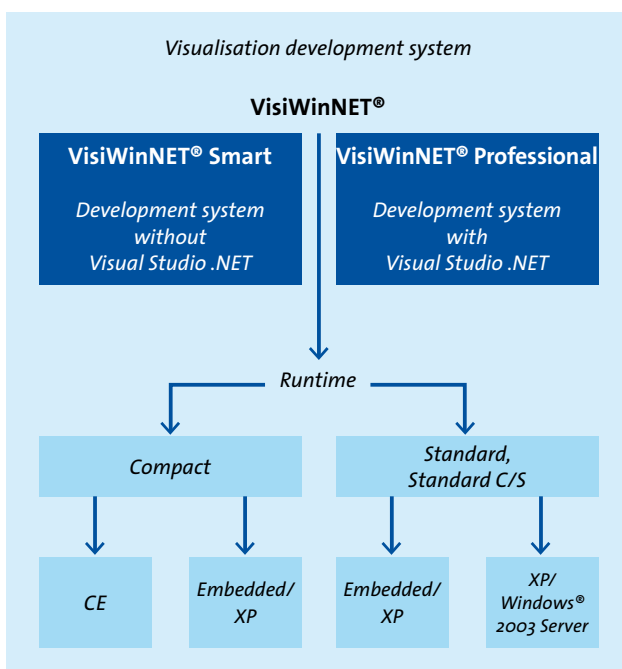

The L-force Visu VisiWinNET® comprises the development software for creating applications and an operating system-dependent runtime component for installation on the destination hardware.



L-force Visu runtime systems

Applications

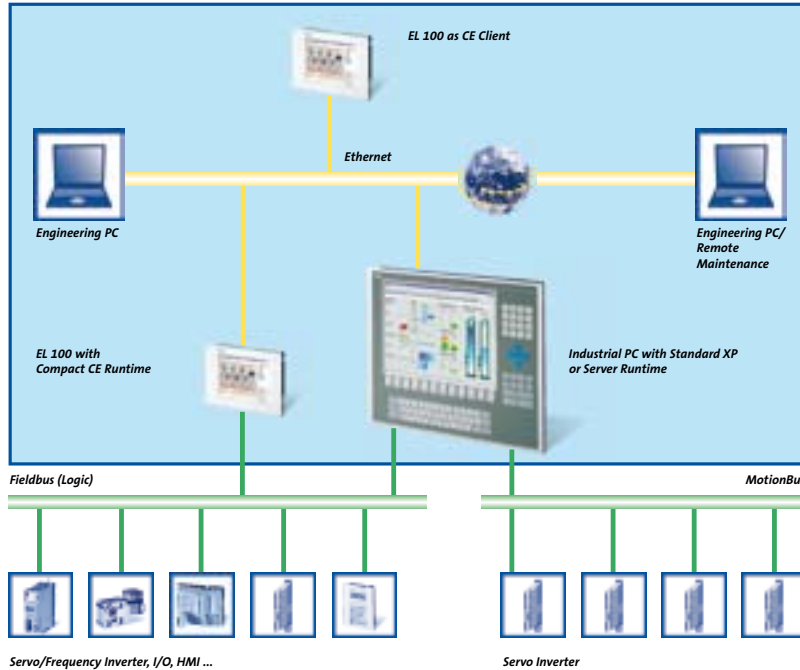

Vertical communication



VisiWinNET® supports all visualisation solutions with its single and multiple location runtime system applications. The VisiWinNET® Standard and C/S runtime versions provide an OPC server interface for the integration of machines into a higher-level host system (ERP) and for data exchange between individual machine and plant components.



Comparison of the functional range of VisiWinNET® runtime systems

Application	Simple operate & monitor functions under Windows® CE	Operate & monitor functions under Windows® Embedded	Visualisation under Windows® XP for complex machine operation	Client/server applications for control station solutions
Target system	Windows® CE	Windows® Embedded Standard 2009	Windows® XP	Windows® XP or Windows® Server 2003
Runtime version	Compact CE	Compact XP	Standard XP	Standard XP/CS
Client/server	Client only	No	No	Yes
Development system(s)	VisiWinNET® Professional or Smart			
Microsoft® Visual Studio .NET required	Only for VisiWinNET® Professional	Only for VisiWinNET® Professional	Only for VisiWinNET® Professional	Only for VisiWinNET® Professional
Functional comparison				
Use of Word, Excel and Outlook	No	Yes	Yes	Yes
Printing	PCL printer only	Yes	Yes	Yes
History/archive/trends	Online + history (depending on memory capacity)	Online + history (depending on memory capacity)	Online + history	Online + history
Alarm history	Yes	Yes	Yes	Yes
Logging	No	No	Yes	Yes
Number of pages	Depends on memory capacity	Depends on memory capacity	Unlimited	Unlimited
Objects per image	Depends on memory capacity	Depends on memory capacity	Unlimited	Unlimited
System is OPC server	No	No	Yes	Yes
Connection via OPC	Yes	Yes	Yes	Yes
Connection via driver	Yes (VisiWinNET® driver only)	Yes (VisiWinNET® driver only)	Yes	Yes
Number of power tags	Max. 2000	Max. 2000	Unlimited	Unlimited
Logic	Restricted under VisiWinNET® Smart Custom system extensions possible with VisiWinNET® Professional			Yes
Recipes	XML	XML	XML/MDB	XML/MDB
Colour gradients	No	No	Option	Option
Transparency	No	No	Option	Option
FDA	Restricted	Restricted	Yes	Yes
Database handling	Only if application was developed with VisiWinNET® Professional			Yes

Products

HMI with Windows® CE		Versions available
	Embedded Line	EL 100 (EL 103 ECO, EL 105m – EL110) <ul style="list-style-type: none"> ▶ 8.9 cm (3.5") to 26.4 cm (10.4") ▶ Integrated CAN or MPI interface ▶ Ethernet on board ▶ For L-force Visu (VisiWinNET® Compact CE Runtime)
	Command Station	CS 5800 – CS 9800 <ul style="list-style-type: none"> ▶ 38.1 cm (15") to 48.3 cm (19") ▶ Various front/keyboard versions <ul style="list-style-type: none"> – stand-alone, all-round IP65 protection – flexible support arm mounting ▶ Interfaces: <ul style="list-style-type: none"> – 2-way CAN – MPI/PROFIBUS ▶ Ethernet on board ▶ For L-force Visu (VisiWinNET® Compact CE, Compact XP, or Standard XP Runtime)
	Embedded Line	EL 1800 – EL 9800 <ul style="list-style-type: none"> ▶ 26.4 cm (10.4") to 48.3 cm (19") ▶ Various front/keyboard versions ▶ Interfaces: <ul style="list-style-type: none"> – 2-way CAN – 4-way CAN – MPI/PROFIBUS ▶ Ethernet on board ▶ For L-force Visu (VisiWinNET® Compact CE, Compact XP, or Standard XP Runtime)
	Control cabinet PC	CPC 2800 <ul style="list-style-type: none"> ▶ Control cabinet mounting ▶ Monitor panel available as screen <ul style="list-style-type: none"> – MP DVI (Embedded Line design) – CS DVI (Command Station design) ▶ Interfaces: <ul style="list-style-type: none"> – 2-way CAN – 4-way CAN – MPI/PROFIBUS ▶ Ethernet on board ▶ For L-force Visu (VisiWinNET® Compact CE, Compact XP, or Standard XP Runtime)

For detailed hardware system features of these industrial PCs, please refer to chapter 3 "Industrial PC".



Visualisation technology with CANopen





CANopen

- ▶ Access to field devices and control systems
- ▶ Access to SDOs/PDOs
- ▶ Import of visualisation variables from EDS or GDC files possible.

Visualisation with CANopen

Visualisation applications can be implemented on EL 100 series HMIs and x800 series IPCs with coupling of field devices and control systems via CANopen.

In addition to visualisation on the IPC, EL 100 series devices can obtain their data directly from the CANopen logic bus and/or visualise data from the L-force control system via TCP/IP.

Hardware including operating system			HMI	Embedded Line	Industrial PC	
			with Windows® CE		Command Station	Control cabinet PC
Device range:			 EL 100	 EL 1800 – EL 9800	 CS 5800 - 9800	 CPC 2800
Software	L-force Visu	Runtime software				
		VisiWinNET® Compact CE	●	●	●	●
		VisiWinNET® Compact XP		●	●	●
		VisiWinNET® Standard XP		●	●	●
Communication	CANopen	Integrated interface	●			
		MC-CAN2		●	●	●

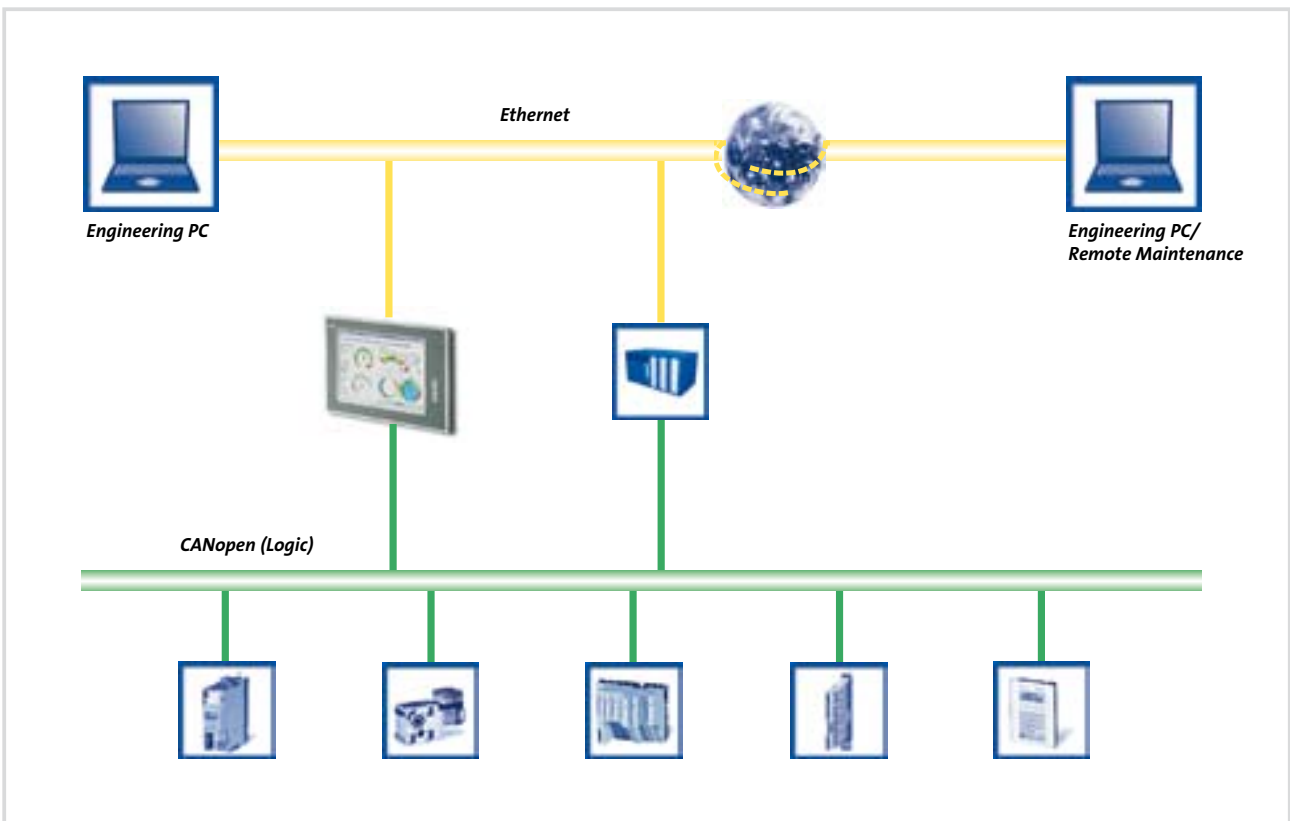

Visualisation technology with PROFIBUS/MPI







- ▶ Coupling to the MPI/PROFIBUS interface of a control system
- ▶ Import of variables from an S7 project possible

Visualisation with PROFIBUS/MPI

With Lenze IPCs and EL 100 series HMIs, visualisation applications can also be implemented on PROFIBUS or with direct coupling to the MPI interface of a control system.

To simplify creation of the application, it is also possible to import all variables from an S7 PLC program.

Communication drivers are available for all L-force runtime systems.

Hardware including operating system			HMI with Windows® CE	Embedded Line	Industrial PC Command Station	Control cabinet PC
						
Device range:			EL 100	EL 1800 – EL 9800	CS 5800 - 9800	CPC 2800
Software	L-force Visu	Runtime software				
		VisiWinNET® Compact CE	●	●	●	●
		VisiWinNET® Compact XP		●	●	●
		VisiWinNET® Standard XP		●	●	●
Communication	PROFIBUS	Integrated interface	●			
		MC-MPI		●	●	●

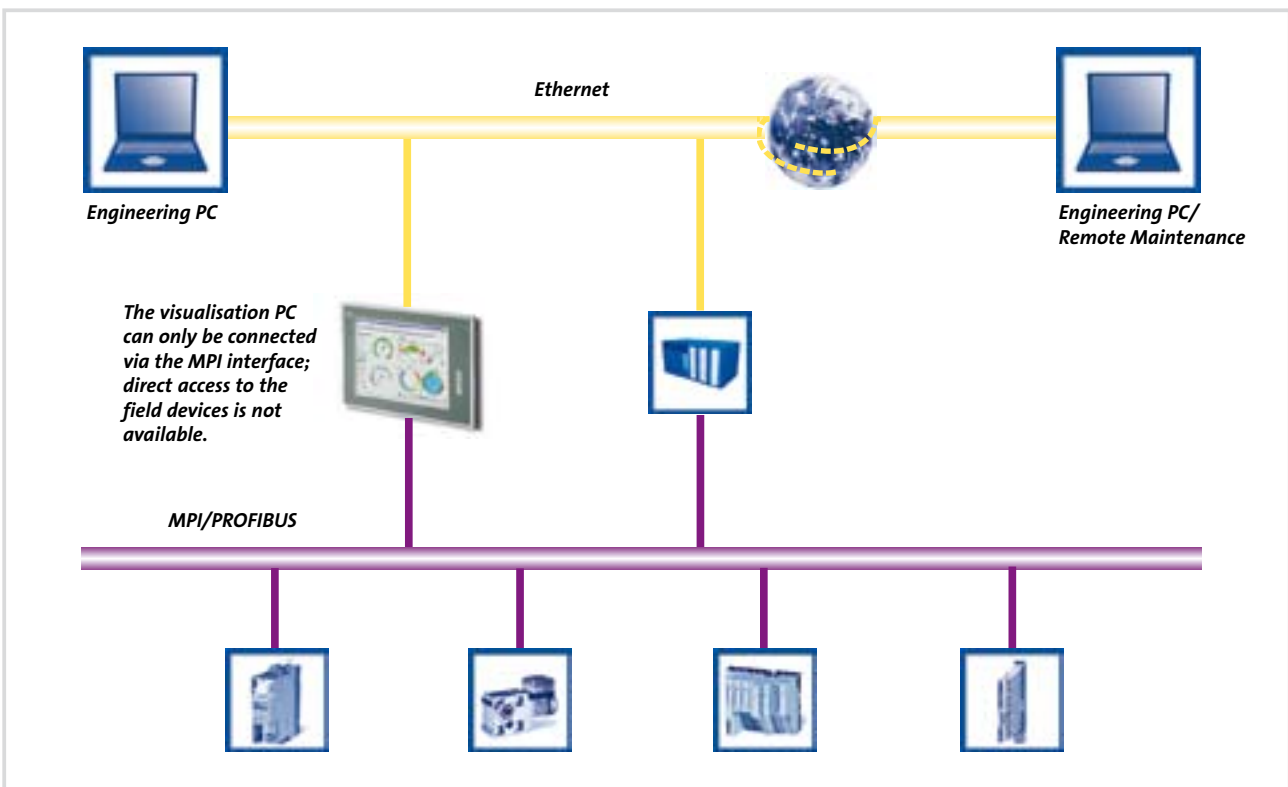



Visualisation technology with PROFINET







- ▶ Coupling to the PROFINET interface of a control system
- ▶ Access to Siemens S7-300/400 control systems and to VIPA control systems via PROFINET (RFC 1006)
- ▶ Import of variables from an S7 project
- ▶ PROFINET connection via the standard Ethernet interface (S7 TCP/IP communication drivers)

Visualisation with PROFINET

With Lenze IPCs, visualisation applications can be implemented at the PROFINET interface of a control system.

To simplify creation of the application, it is also possible to import all variables from an S7 PLC program.

Communication drivers are available for all L-force runtime systems.

Hardware including operating system		HMI with Windows® CE	Embedded Line	Industrial PC	
				Command Station	Control cabinet PC
Device range:		 EL 100	 EL 1800 – EL 9800	 CS 5800 - 9800	 CPC 2800
Software	L-force Visu Runtime software				
	VisiWinNET® Compact CE	●	●	●	●
	VisiWinNET® Compact XP		●	●	●
	VisiWinNET® Standard XP		●	●	●
Communication	PROFINET Standard Ethernet interface	●	●	●	●

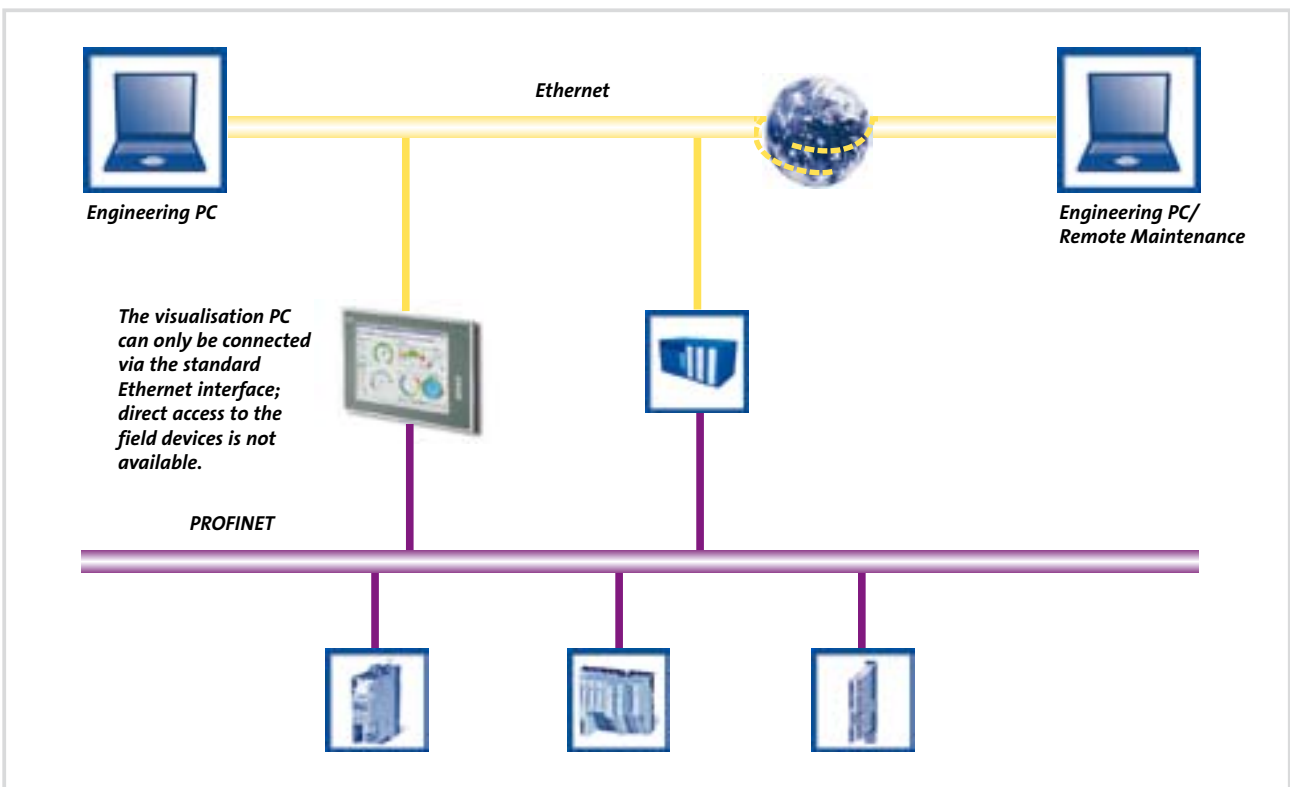

Visualisation technology via Ethernet





- ▶ Connection to all PLCs with S7-compatible Ethernet interfaces (MPI via TCP/IP) such as Siemens, VIPA, SAIA
- ▶ Import of variables from an S7 project
- ▶ Continuous remote maintenance possible via TCP/IP

Visualisation with TCP/IP

With Lenze IPCs, visualisation applications can be implemented for control systems with a Siemens-compatible Ethernet interface (MPI via TCP/IP). This type of communication can also be used for connecting to a PROFIBUS interface. This option is possible with Siemens, VIPA and SAIA control systems.

To simplify creation of the application, it is also possible to import all variables from an S7 PLC program.

Communication drivers are available for all L-force runtime systems.

Hardware including operating system			HMI with Windows® CE	Embedded Line	Industrial PC	
					Command Station	Control cabinet PC
						
Device range:			EL 100	EL 1800 – EL 9800	CS 5800 - 9800	CPC 2800
Software	L-force Visu	Runtime software				
		VisiWinNET® Compact CE	●	●	●	●
		VisiWinNET® Compact XP		●	●	●
		VisiWinNET® Standard XP		●	●	●
Communication	Ethernet	Integrated interface	●	●	●	●

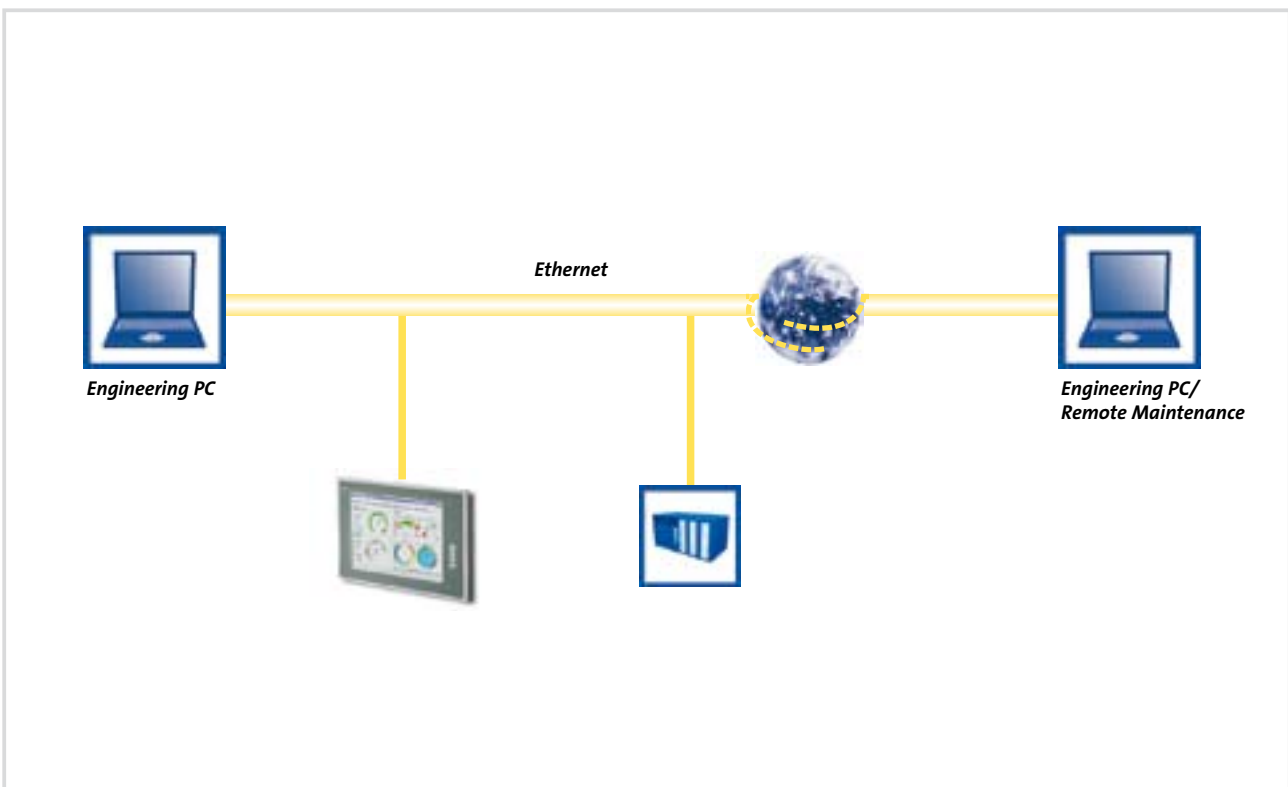









HMIs with Windows® CE – EL 100 series







The EL 100 series HMIs with Windows® CE are graphical touchscreen devices. With display sizes ranging from 8.9 cm (3.5") to 26.4 cm (10.4") they are cost-effective yet high-performance complete systems for operation and monitoring functions.

These HMIs come with tried-and-tested IPC standard interfaces and offer a wide variety of communication options with both Lenze products and other control systems. They are also available with an integrated control system as an option (see chapter 1):

Rated data

Type	EL 103 ECO	EL 105 mono	EL 105 colour	EL 106	EL 108	EL 110	EL 110s
							
Display							
Type	TFT 64k colours 8.9 cm (3.5")	STN 16 grey scale 14.5 cm (5.7")	TFT 64k colours 14.5 cm (5.7")	TFT 64k colours 16.3 cm (6.4")	TFT 64k colours 20.3 cm (8")	TFT 64 colours 26.4 cm (10.4")	TFT 64k colours 26.4 cm (10.4")
Touchscreen	resistive						
Resolution [pixels]	320 x 240	320 x 240	320 x 240	640 x 480	640 x 480	640 x 480	800 x 600
CPU	XScale PXA 270						
User memory	Flash (Standard / PLC) RAM (Standard / PLC)		32 MB / 64 MB 64 MB / 128 MB				
Interfaces	Serial port USB Ethernet		RS232 Host (A) / Device (B) 10 / 100MBit / RJ45				
Fieldbus HMI devices Fieldbus PLC devices	CAN CAN		CAN/MPI CAN				
Clock	Yes, buffer time 2 weeks		Yes, with back-up battery, off time 7 years at 25°C				
DC supply voltage U _{DC} [V]	24 ± 25 %						
Power input at DC 24 V [W]	5.0	6.0	7.2	7.2	12	12	12
Operating system	Windows® CE 5.0						
Dimensions							
Height H [mm]	104	155	155	155	180	220	220
Width W [mm]	130	210	210	210	250	275	275
Depth D [mm]	34	50	50	50	50	50	50
Weight [kg]	0.4	1.1	1.1	1.2	1.5	2.0	2.0
System features	<ul style="list-style-type: none"> ▶ Approval: UL 508, CSA C22 2, EN 61000 6-2(4), EN 55022, EN 55024 ▶ Enclosure: front IP65, rear IP20, UL type rating 1, 2 and 5 ▶ Front construction: aluminium with polyester foil, according to DIN 42115 ▶ Cover construction: sheet steel, zinc-plated ▶ Temperature range: operation: HMI devices 0-50°C, PLC devices 0-40°C, storage 0-60°C ▶ Relative humidity: 10% to 90%, non-condensing ▶ Maximum altitude: 3000 m above sea level 						

Functions

Type	EL 103 ECO	EL 105 mono	EL 105 colour	EL 106	EL 108	EL 110	EL 110s
							
Visualisation functions							
Online languages	According to preference						
Password	According to preference						
Dynamic texts	Yes						
Bitmaps	Import option during configuration						
Graphical symbols	Static/dynamic						
Alarms	Yes						
Messages	Yes						
Alarm buffer	Yes						
Recipes	Yes						
Trend display	Line graph						
Number of power tags	500					1000	
PLC functions (IEC 61131-3)							
IL, FBD, LD, ST, SFC and CFC editor	Yes			Yes			
Program code	256 kB			2 MB			
Data memory, variables	64 kB			1 MB			
Data memory, global variables	64 kB			512 kB			
Flags	4 kB			4 kB			
Input (process image)	1 kB			4 kB			
Output (process image)	1 kB			4 kB			
Retain data	16 kB			128 kB			
Integrated UPS for saving retain data in flash memory	Yes			Yes			

Differences between Windows® CE Core and Professional Plus

	Description	Windows® CE 5.0 Core	Windows® CE 5.0 Professional	Windows® CE 5.0 Professional Plus
Web server		+	+	+
Remote desktop: VNC		+	+	+
FTP server		+	+	+
RAS server		-	+	+
Telnet		+	+	+
ActiveSync file transfer		+	+	+
Internet Explorer 6		-	-	+
Registry editor		+	+	+
WordPad		-	+	+
USB keyboard driver		+	+	+
HP printer driver: PCL		+	+	+
File viewer	Excel, image, PDF, PowerPoint and Word viewer	-	-	+
HMI start manager		+	+	+
.NET Compact Framework 2.0		+	+	+
USB support		+	+	+
Touchscreen driver		+	+	+
TCP/IP		+	+	+
CAN	Driver, Control Panel applet	+	+	+
MPI	Driver, Control Panel applet	+	+	+
Soft keyboard		+	+	+
Control panels		+	+	+
Network tools	Ping, Tracert, Netstat, Net	+	+	+
Visual Studio communication components	CommandClient2, Clientsshutdown	+	+	+







Order data

Embedded Line EL 100 ECO with visualisation

			Order code	
	EL 103 ECO	8.9 cm (3.5") TFT display, colour (320 x 240)	3390-	<input type="checkbox"/> <input type="checkbox"/>
	Communication interfaces	CAN		1
	Operating system	Windows® CE 5.0 Core (English) Windows® CE 5.0 Professional Plus (English)		1 2
	Runtime L-force Visu	VisiWinNET® Compact CE		
	Order code	Your solution:	<input type="checkbox"/> <input type="checkbox"/> <input type="checkbox"/> <input type="checkbox"/>	<input type="checkbox"/> <input type="checkbox"/>

Order data

Embedded Line EL 100 with visualisation





			Order code	
	EL 105	14.5 cm (5.7") STN display, monochrome (320 x 240) 14.5 cm (5.7") TFT display, colour (320 x 240)	3250- 3251-	<input type="checkbox"/> <input type="checkbox"/> <input type="checkbox"/> <input type="checkbox"/>
	EL 106	16.3 cm (6.4") TFT display, colour (640 x 480)	3252-	<input type="checkbox"/> <input type="checkbox"/>
	EL 108	20.3 cm (8.0") TFT display, colour (640 x 480)	3253-	<input type="checkbox"/> <input type="checkbox"/>
	EL 110 EL 110s	26.4 cm (10.4") TFT display, colour (640 x 480) 26.4 cm (10.4") TFT display, colour (800 x 600)	3254- 3258-	<input type="checkbox"/> <input type="checkbox"/> <input type="checkbox"/> <input type="checkbox"/>
	Communication interfaces	CAN MPI		1 2
	Operating system	Windows® CE 5.0 Core (English) Windows® CE 5.0 Professional Plus (English)		1 2
	Runtime L-force Visu	VisiWinNET® Compact CE		
	Order code	Your solution:	<input type="checkbox"/> <input type="checkbox"/> <input type="checkbox"/> <input type="checkbox"/>	<input type="checkbox"/> <input type="checkbox"/>

Order data





Embedded Line EL 100 ECO PLC with control technology

			Order code		
	EL 103 ECO PLC	8.9 cm (3.5") TFT display, colour (320 x 240)	3391-	<input type="checkbox"/>	<input type="checkbox"/>
	Communication interfaces	CAN		1	
	Operating system	Windows® CE 5.0 Core (English) Windows® CE 5.0 Professional Plus (English)			1 2
	Runtime L-force Logic L-force Visu	LPC 1000 (soft PLC) VisiWinNET® Compact CE			
	Order code	Your solution:	<input type="checkbox"/> <input type="checkbox"/> <input type="checkbox"/> <input type="checkbox"/>	<input type="checkbox"/>	<input type="checkbox"/>

Embedded Line EL 100 PLC with control technology

			Order code		
	EL 105 PLC	14.5 cm (5.7") STN display, monochrome (320 x 240) 14.5 cm (5.7") TFT display, colour (320 x 240)	3350- 3351-	<input type="checkbox"/> <input type="checkbox"/>	<input type="checkbox"/> <input type="checkbox"/>
	EL 106 PLC	16.3 cm (6.4") TFT display, colour (640 x 480)	3352-	<input type="checkbox"/>	<input type="checkbox"/>
	EL 108 PLC	20.3 cm (8.0") TFT display, colour (640 x 480)	3353-	<input type="checkbox"/>	<input type="checkbox"/>
	EL 110 PLC EL 110s PLC	26.4 cm (10.4") TFT display, colour (640 x 480) 26.4 cm (10.4") TFT display, colour (800 x 600)	3354- 3355-	<input type="checkbox"/> <input type="checkbox"/>	<input type="checkbox"/> <input type="checkbox"/>
	Communication interfaces	CAN		1	
	Operating system	Windows® CE 5.0 Core (English) Windows® CE 5.0 Professional Plus (English)			1 2
	Runtime L-force Logic L-force Visu	LPC 1000 (soft PLC) VisiWinNET® Compact CE			
	Order code	Your solution:	<input type="checkbox"/> <input type="checkbox"/> <input type="checkbox"/> <input type="checkbox"/>	<input type="checkbox"/>	<input type="checkbox"/>

Embedded Line EL 100 accessories

			Order code		
	SD card	SD card 128 MB standard quality SD card 256 MB standard quality SD card 512 MB standard quality SD card 1 GB standard quality			EPCZEMSS1 EPCZEMSS2 EPCZEMSS3 EPCZEMSS4
	CAN bus plug	"Node" CAN bus plug - Sub-D, 90° - Screw terminals			EPM-T950
		"Termination" CAN bus plug - Sub-D, 90° - Screw terminals - Integrated terminating resistor			EPM-T951
		"Straight" CAN bus plug - Sub-D, 180° - Screw terminals - Switchable terminating resistor			EPM-T952
		"Switch" CAN bus plug - Sub-D, 90° - Tension spring terminal - Switchable terminating resistor			EWZ0046



Order data

VisiWinNET® runtime systems

Can be ordered separately for all non-bundled systems

Item description			Order code			
VisiWinNET® 50	50 power tags	Compact CE	7700	4410	6	005
		Compact XP	7700	4420	6	005
VisiWinNET® 100	100 power tags	Compact CE	7700	4410	6	010
		Compact XP	7700	4420	6	010
VisiWinNET® 250	250 power tags	Compact CE	7700	4410	6	025
		Compact XP	7700	4420	6	025
		Standard XP	7700	4430	<input type="checkbox"/>	025
		Standard client/server	7700	4440	<input type="checkbox"/>	025
VisiWinNET® 500	500 power tags	Compact CE	7700	4410	6	050
		Compact XP	7700	4420	6	050
		Standard XP	7700	4430	<input type="checkbox"/>	050
		Standard client/server	7700	4440	<input type="checkbox"/>	050
VisiWinNET® 1000	1000 power tags	Compact CE	7700	4410	6	100
		Compact XP	7700	4420	6	100
		Standard XP	7700	4430	<input type="checkbox"/>	100
		Standard client/server	7700	4440	<input type="checkbox"/>	100
VisiWinNET® 2000	2000 power tags	Compact CE	7700	4410	6	200
		Compact XP	7700	4420	6	200
		Standard XP	7700	4430	<input type="checkbox"/>	200
		Standard client/server	7700	4440	<input type="checkbox"/>	200
VisiWinNET® 4000	4000 power tags	Standard XP	7700	4430	<input type="checkbox"/>	400
		Standard client/server	7700	4440	<input type="checkbox"/>	400
VisiWinNET® 64000	64000 power tags	Standard XP	7700	4430	<input type="checkbox"/>	999
		Standard client/server	7700	4440	<input type="checkbox"/>	999
VisiWinNET® Client	Operate + monitor (client) for Windows® XP	Additional client for client/server applications (standard C/S for Win XP)	7700	4440	<input type="checkbox"/>	001
VisiWinNET® Viewer	Monitor (viewer) for Windows® XP	Additional client for client/server applications (standard C/S for Win XP)	7700	4440	<input type="checkbox"/>	002
Licensing	USB dongle				5	
	Licence file tied to hardware *) ¹				6	
Order code	Your solution:		<input type="checkbox"/> <input type="checkbox"/> <input type="checkbox"/> <input type="checkbox"/>	<input type="checkbox"/> <input type="checkbox"/> <input type="checkbox"/> <input type="checkbox"/>	<input type="checkbox"/>	<input type="checkbox"/> <input type="checkbox"/> <input type="checkbox"/>

^{*)} Standard licensing procedure for all bundled systems

VisiWinNET® engineering software

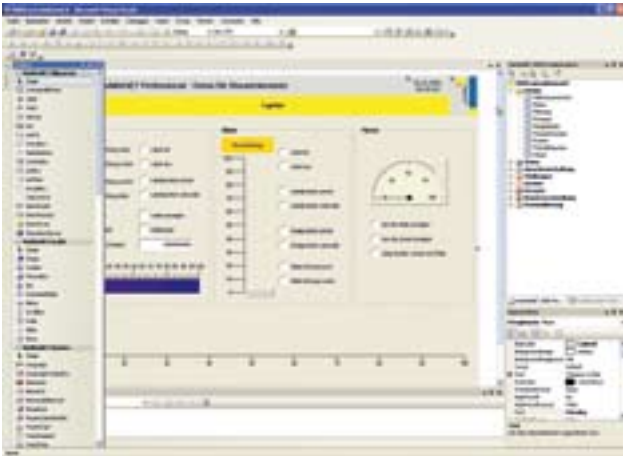

VisiWinNET®
As a supplier of complete systems for the drive and automation technology sector, we of course attach particular importance to the usability of your installation. VisiWinNET® is an innovative visualisation system which satisfies the high quality standards you have come to expect from all Lenze products. What's more, the coupling of VisiWinNET® to a Lenze system allows direct import of process variables for added convenience.

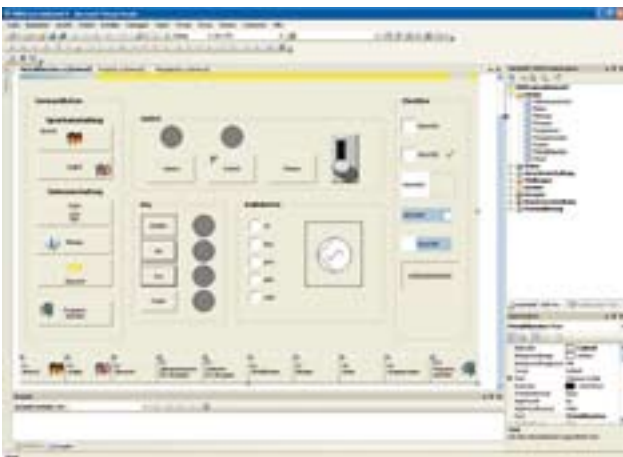

Openness
VisiWinNET® finally removes the barriers imposed by proprietary visualisation systems. Drawing on innovative technologies and tried-and-tested standards, VisiWinNET® is a uniform, integrated visualisation software platform for mechanical and systems engineering.

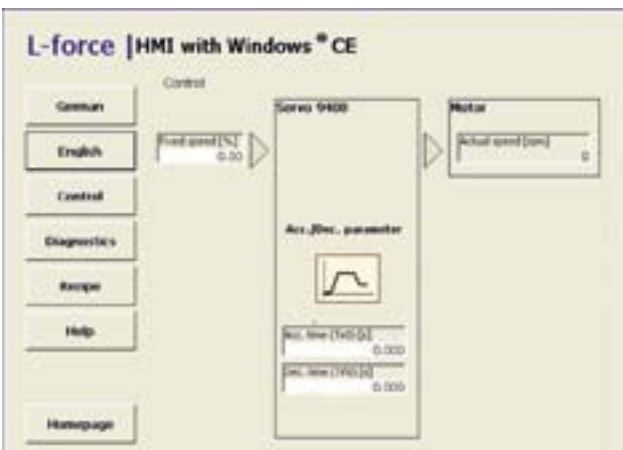

Flexibility
The greatest strength of the VisiWinNET® system lies in the fact that it is fully integrated into Microsoft® Visual Studio .NET. It provides access to all Windows® functions, multimedia, databases and the Office environment. The object-oriented script languages C# and Visual Basic.NET are also available. In this way VisiWinNET® can be used to execute custom tasks which are difficult to implement with ready-made visualisation functions.



VisiWinNET® overview

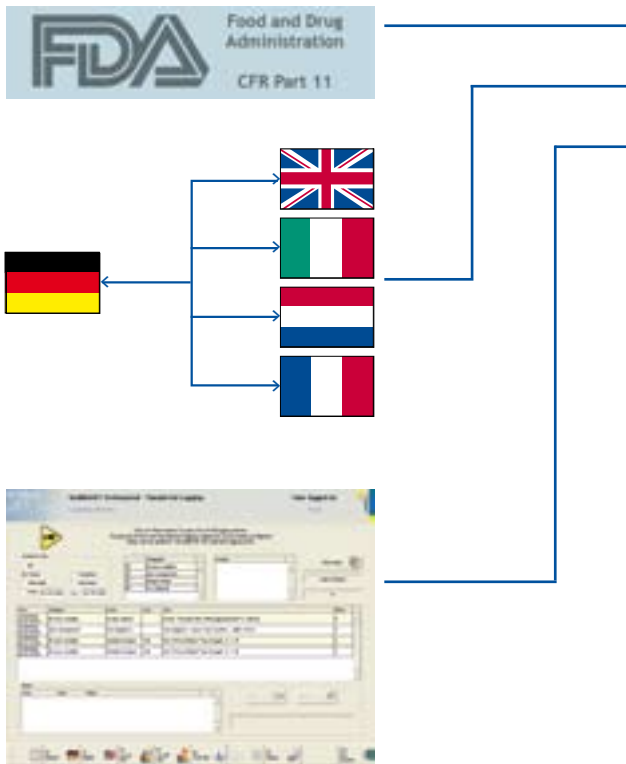

Features

- ▶ Worldwide validation with integrated FDA CFR Part 11 conformity (VisiWinNET® Professional only)
- ▶ Unicode-based language and unit switching for all languages worldwide
- ▶ Extensive diagnostics options with cross-reference lists, trend recording and process value tracking
- ▶ Numerous visualisation functions: reporting system, archiving, user management, recipe system, logging, and much more

Structure

- ▶ Excellent compatibility through the use of standard operating systems
- ▶ Scalability in terms of operating system and efficiency

Communication

- ▶ Communication across processes and remote maintenance options through the use of open protocol standards
- ▶ Continuous communication from the fieldbus through to control station and applications planning

Workflow

- ▶ Can be used for applications ranging from a simple system for creating operation and monitoring applications on HMIs through to complex SCADA systems
- ▶ VisiWinNET® Smart offers simple and flexible extension options using VB.NET scripts.
- ▶ Ready-made templates and control elements which can be modified at any time

VisiWinNET® tools

Development software

To enable individual tasks to be covered as fully as possible, VisiWinNET® is available in two independent versions.

VisiWinNET® Smart

VisiWinNET® Smart is a user-friendly visualisation system for creating simple interfaces. It is suitable for use as a flexible tool for creating simple applications or as a service tool. VisiWinNET® Smart has its own full-graphics integrated development environment and includes ready-made templates to help users. A particular strength of the system is that it can be used in conjunction with VisiWinNET® Professional.



Features of VisiWinNET® Smart

- ▶ For simple operation and monitoring applications
- ▶ For applications in close proximity to machines

VisiWinNET® Professional

The VisiWinNET® Professional system is fully integrated into the Microsoft® Visual Studio .NET development environment and provides the basis for creating visualisation and SCADA application with high levels of functionality. Ready-made templates and modules support the flexible creation of applications by drag and drop. The system allows custom programming modifications based on Visual Basic .NET and C# where required. In this way it can be used to implement company-specific and complex tasks which standard visualisation functions cannot handle.



Features of VisiWinNET® Professional

- ▶ For complex operation and monitoring applications
- ▶ For client/server-based SCADA systems
- ▶ For custom and company-specific programming
- ▶ For linking to databases or other Office programs
- ▶ For the use of complex reporting functions



VisiWinNET® toolkit system

Visualisation toolkit



Intelligent combination

Using the .NET functions and object-oriented programming it is possible to implement custom control elements and machine modules and to combine them to create an individual visualisation module.

A true visualisation system

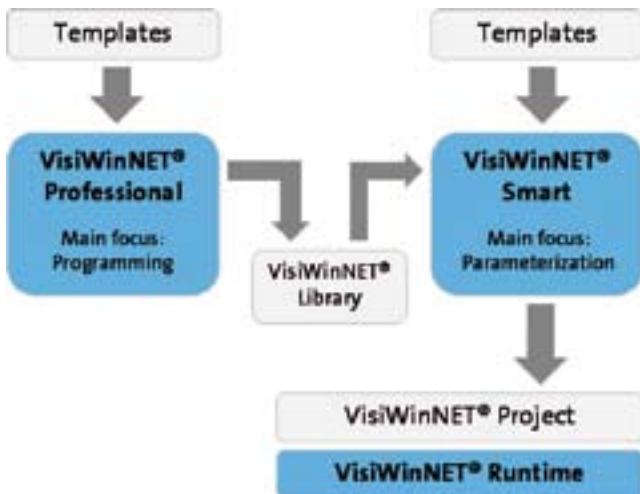

The efficiency of L-force Visu VisiWinNET® is highlighted when VisiWinNET® Smart and Professional are used together.

VisiWinNET® Professional can be used to develop specific machine modules and control elements which are then integrated in Smart with the aid of the VisiWinNET® configurator where they are put to further use.

This convenient function allows users to create commonly occurring functions in accordance with their own requirements.

Order data

VisiWinNET® engineering software





Development environment

- ▶ Development system for single-location applications (Compact, Standard) or client/server applications (Standard XP Client/Server)
- ▶ Documentation in German/English
- ▶ All communication drivers included in delivery

Item description	Development	Runtime				Order code			
		Windows® CE	Windows® Embedded	Windows® XP	Windows® XP Client/Server				
VisiWinNET® Smart	▶ Operating system Windows® XP development	<input checked="" type="checkbox"/>				7710	100	06	<input type="checkbox"/>
		<input checked="" type="checkbox"/>	<input checked="" type="checkbox"/>			7710	110	06	<input type="checkbox"/>
		<input checked="" type="checkbox"/>	<input checked="" type="checkbox"/>	<input checked="" type="checkbox"/>		7710	120	06	<input type="checkbox"/>
		<input checked="" type="checkbox"/>	<input checked="" type="checkbox"/>	<input checked="" type="checkbox"/>	<input checked="" type="checkbox"/>	7710	130	06	<input type="checkbox"/>
Upgrade	▶ from CE to XPe	<input checked="" type="checkbox"/>	<input checked="" type="checkbox"/>			7710	101	06	<input type="checkbox"/>
	▶ from XPe to XP	<input checked="" type="checkbox"/>	<input checked="" type="checkbox"/>	<input checked="" type="checkbox"/>		7710	111	06	<input type="checkbox"/>
	▶ from XP to XP Client/Server	<input checked="" type="checkbox"/>	<input checked="" type="checkbox"/>	<input checked="" type="checkbox"/>	<input checked="" type="checkbox"/>	7710	131	06	<input type="checkbox"/>
VisiWinNET® Professional	▶ Operating system Windows® XP development "MS Visual Studio .NET" 2005 or 2008 is also required!	<input checked="" type="checkbox"/>				on request			<input type="checkbox"/>
		<input checked="" type="checkbox"/>	<input checked="" type="checkbox"/>						<input type="checkbox"/>
		<input checked="" type="checkbox"/>	<input checked="" type="checkbox"/>	<input checked="" type="checkbox"/>					<input type="checkbox"/>
		<input checked="" type="checkbox"/>	<input checked="" type="checkbox"/>	<input checked="" type="checkbox"/>	<input checked="" type="checkbox"/>				<input type="checkbox"/>
Upgrade	▶ from CE to XPe	<input checked="" type="checkbox"/>	<input checked="" type="checkbox"/>			on request			<input type="checkbox"/>
	▶ from XPe to XP	<input checked="" type="checkbox"/>	<input checked="" type="checkbox"/>	<input checked="" type="checkbox"/>					<input type="checkbox"/>
	▶ from XP to XP Client/Server	<input checked="" type="checkbox"/>	<input checked="" type="checkbox"/>	<input checked="" type="checkbox"/>	<input checked="" type="checkbox"/>				<input type="checkbox"/>
Licensing	USB dongle Licence file tied to hardware					on request			5 <input type="checkbox"/>
Order code	Your solution:					□□□□	□□□	□□	<input type="checkbox"/>



Designs

EPM-H		Versions available
	Text display	Text displays are a low-cost and compact solution for simple applications. Their narrow mounting depth makes them ideal where space is at a premium. The two- to four-line displays are backlit and include a system bus as standard as well as various system and function keys.
	Graphics display	Graphics displays combine cost-effectiveness, functionality and maximum user-friendliness in a modern design. The compact units with integrated system bus are able to manage recipes and display data in graphical format. Production trends are immediately apparent, allowing machine processes to be optimised.
	Touchscreen	Our range of touchscreens covers all requirements, from a low-cost entry-level solution to a 10.4" TFT version for more challenging visualisation applications. All units feature a system bus and have an highly flexible user interface.
	Hand-held	For direct local operation and monitoring. The ability to use the console directly whilst in sight of the machine or workpiece speeds up the commissioning process considerably. The lightweight construction and touchscreen design make the console very easy to operate.

Visualisation software





HMI Designer – one software for all EPM-H devices

HMI Designer provides a uniform integrated development environment for all of the operating and display units described above.

- ▶ **Project planning**
The clearly laid-out programming environment, featuring a project manager, project editor and script editor, integrates device configurations for Lenze drive controllers, simplifying project planning and subsequent operation.
- ▶ **Handling**
The tool allows export and import of all texts for simple translation into other languages. Once variables and recipes have been created, they can be copied to other devices within the HMI product range.

Text display

Rated data

Order designation	EPM-H310	EPM-H312	EPM-H315
			
Display	Text, LED-backlit LC display	Text, LED-backlit LC display	Text, LED-backlit LC display
Type			
Display size [mm]	73.5 x 11.5	73.5 x 11.5	70.4 x 20.8
Lines x characters	2 x 20	4 x 20	4 x 20
Text character matrix [pixels]	5 x 7	5 x 7	5 x 7
Character size [mm]	3.2 x 5.5	2.95 x 4.75	2.95 x 4.75
User memory			
Application program	48 kB	256 kB	256 kB
Interfaces			
Serial port ASP8	RS 232	RS 232	RS 232
Fieldbus	CAN system bus	CAN system bus	CAN system bus
Clock			
Real-time clock with date	No	No	No
DC supply voltage			
U_{DC} [V]	24 (+18 ... 32)	24 (+18 ... 32)	24 (+18 ... 32)
Power input at 24 V DC			
[W]	5	5	15
System features	<ul style="list-style-type: none"> ▶ Conformity: Electromagnetic compatibility (89/336/EEC) ▶ Approvals: UL 508, cULus, File No. E189179 ▶ Enclosure: front IP65 ▶ Climatic conditions, permissible humidity: non-condensing, humidity < 85 % ▶ Climate requirements: -20 °C ... +60 °C, storage (EN 60721-3-1), -20 °C ... +60 °C transport (EN 60721-3-2), 0 °C ... +50 °C operation (EN 60721-3-3) ▶ Emitted interference EN 61000-6-4 ▶ Immunity to interference EN 61000-6-2 		
Functions			
Online languages	4	4	6
Password	No	No	10 levels
Bit password	8 bit	8 bit	8 bit
Pages/help	127/127	127/127	1024/1024
Variables per page	12	12	32
Variable format	DEC, HEX, BIN, BCD, Floating point	DEC, HEX, BIN, BCD, Floating point	DEC, HEX, BIN, BCD, Floating point
Dynamic texts	Yes	Yes	Yes
Alarms	No	No	No
Messages	128	128	1024
Alarm buffer	No	No	No
Recipes	No	No	No
System and function keys	8/5	6/4	20/5
Dimensions			
Height H [mm]	86	86	188
Width W [mm]	166	166	148
Depth D [mm]	41	41	41
Weight			
m [kg]	0.5	0.5	0.7





Graphics display

Rated data

Order designation		EPM-H410
		
Display		Graphics, LED-backlit LC display
Type		132 x 39
Display size	[mm]	240 x 64
Resolution	[pixels]	2 x 10/4 x 20/8 x 40
Lines x characters		6 x 8/12 x 16/24 x 32
Text character matrix	[pixels]	3.2 x 4.2/6.5 x 8.5/12.7 x 17
Character size	[mm]	
User memory		
Application program		512 kB
Interfaces		
Serial port ASP8		RS232
Fieldbus		CAN system bus
Clock		
Real-time clock with date		Yes, with back-up battery
DC supply voltage		
	U _{DC} [V]	24 (+18 ... 32)
Power input		
at 24 V DC	[W]	11
System features		<ul style="list-style-type: none"> ▶ Conformity: Electromagnetic compatibility (89/336/EEC) ▶ Approvals: UL 508, cULus, File No. E189179 ▶ Enclosure: front IP65 ▶ Climatic conditions, permissible humidity: non-condensing, humidity < 85% ▶ Climate requirements: -20 °C ... +60 °C, storage (EN 60721-3-1), -20 °C ... +60 °C transport (EN 60721-3-2), 0 °C ... +50 °C operation (EN 60721-3-3) ▶ Emitted interference EN 61000-6-4 ▶ Immunity to interference EN 61000-6-2
Functions		
Online languages		8
Password		10 levels
Bit password		8 bit
Pages/help		1024/1024
Variables per page		80
Variable format		DEC, HEX, BIN, BCD, Floating point
Dynamic texts		Yes
Bitmaps		Import option during configuration
Graphical symbols		Static/dynamic
Alarms		1024
Messages		1024
Alarm buffer		256
Recipes	[kb]	128
Trend display		Line or point
System and function keys		25/24
Dimensions		
Height	H [mm]	196
Width	W [mm]	252
Depth	D [mm]	65
Weight		
	m [kg]	1.5

Touchscreen



Rated data

Order designation	EPM-H502	EPM-H505	EPM-H507
			
Display	Graphics, LCD 4 grey scale STN 4"	Graphics, LCD 4 blue scale STN 5.6"	Graphics, LCD 16 colours STN 5.6"
Type	94.5 x 54.5	115.2 x 86.4	115.2 x 86.4
Display size [mm]	Matrix 20 x 8 (12 x 16 pixels each)	Matrix 20 x 16 (16 x 15 pixels each)	Matrix 20 x 16 (16 x 15 pixels each)
Resolution [pixels]	240 x 128	320 x 240	320 x 240
Lines x characters	4 x 10/8 x 20/16 x 40	4 x 10/8 x 20/16 x 40	4 x 10/8 x 20/16 x 40
Text character matrix [pixels]	6 x 8/12 x 16/24 x 32	8 x 15/ 16 x 30 / 32 x 60	8 x 15 / 16 x 30 / 36 x 60
Character size [mm]	2.3 x 5.2/4.6 x 5.8/9.1 x 11.7	2.8 x 5.2/5.6 x 10.4/11.2 x 20.8	2.8 x 5.2 / 5.6 x 10.4 / 11.2 x 20.8
Service life of background lighting [h]		45000	45000
User memory			
Application program	640 kB	640 kB	960 kB
Interfaces			
Serial port ASP8	RS232	RS232	RS232
Fieldbus	CAN system bus	CAN system bus	CAN system bus
Clock			
Real-time clock with date	Yes	No	Yes
DC supply voltage			
U _{DC} [V]	24 (+18 ... 32)	24 (+18 ... 32)	24 (+18 ... 32)
Power input at 24 V DC			
[W]	10	10	10
System features	<ul style="list-style-type: none"> ▶ Conformity: Electromagnetic compatibility (89/336/EEC) ▶ Approvals: UL 508, cULus, File No. E189179 ▶ Enclosure: front IP65 ▶ Climatic conditions, permissible humidity: non-condensing, humidity < 85% ▶ Climate requirements: -20 °C ... +60°C, storage (EN 60721-3-1), -20 °C ... +60 °C transport (EN 60721-3-2), 0 °C ... +50 °C operation (EN 60721-3-3) ▶ Emitted interference EN 61000-6-4 ▶ Immunity to interference EN 61000-6-2 		
Functions			
Online languages	4	4	6
Password	10 levels	10 levels	10 levels
Bit password	8 bit	8 bit	8 bit
Pages/help	64/64	64/64	150/150
Variables per page	32	34	34
Variable format	DEC, HEX, BIN, BCD, Floating point	DEC, HEX, BIN, BCD, Floating point	DEC, HEX, BIN, BCD, Floating point
Dynamic texts	Yes	Yes	Yes
Bitmaps	Import option during configuration	Import option during configuration	Import option during configuration
Graphics symbols	Static/dynamic	Static/dynamic	Static/dynamic
Alarms	256	No	No
Messages	256	256	256
Alarm buffer	256	No	No
Recipes [kb]	16	16	32
Trend view	Not possible	Not possible	Not possible
System and function keys	24	24	24
Dimensions			
Height H [mm]	100	158	158
Width W [mm]	166	210	210
Depth D [mm]	43,6	60	60
Weight			
m [kg]	0.5	1.4	1.4





Touchscreen

Rated data

Order designation	EPM-H510	EPM-H520	EPM-H521
			
Display Type	Graphics, LCD monochrome STN 5.5"	Graphics, LCD 256 colours TFT 10.4"	Graphics, LCD 256 colours TFT 10.4"
Display size [mm]	123 x 68	211.2 x 158.4	211.2 x 158.4
Touchscreen	Matrix 20 x 8 (12 x 16 pixels each)	Matrix 40 x 30 (16 x 16 pixels each)	Matrix 40 x 30 (16 x 16 pixels each)
Resolution [pixels]	240 x 128	640 x 480	640 x 480
Lines x characters	4 x 10/8 x 20/16 x 40	7 x 20 / 15 x 40 / 30 x 80	7 x 20 / 15 x 40 / 30 x 80
Text character matrix	6 x 8/12 x 16/24 x 32	8 x 16 / 16 x 32 / 32 x 64	8 x 16 / 16 x 32 / 32 x 64
Character size [mm]	3 x 4 / 6 x 8 / 12 x 16	2.7 x 5.4 / 5.4 x 10.7 / 10.7 x 21.4	2.7 x 5.4 / 5.4 x 10.7 / 10.7 x 21.4
Service life of background lighting	Up to 25°C [h]	15000	30000
User memory			
Application program	512 kB	640 kB	960 kB
Interfaces			
Serial port ASP8	RS232	RS232	RS232
Parallel port LPT	---	Centronics	Centronics
Fieldbus	CAN system bus	CAN system bus	CAN system bus
Clock			
Real-time clock with date	Yes, with back-up battery	Yes, with back-up battery	Yes, with back-up battery
DC supply voltage			
U _{DC} [V]	24 (+18 ... 32)	24 (+18 ... 32)	24 (+18 ... 32)
Power input			
at 24 V DC [W]	15	15	15
System features	<ul style="list-style-type: none"> ▶ Conformity: Electromagnetic compatibility (89/336/EEC) ▶ Approvals: UL 508, cULus, File No. E189179 ▶ Enclosure: front IP65 ▶ Climatic conditions, permissible humidity: non-condensing, humidity < 85% ▶ Climate requirements: -20 °C ... +60 °C, storage (EN 60721-3-1), -20 °C ... +60 °C transport (EN 60721-3-2), 0 °C ... +50 °C operation (EN 60721-3-3) ▶ Emitted interference EN 61000-6-4 ▶ Immunity to interference EN 61000-6-2 		
Functions			
Online languages	8	8	8
Password	10 levels	10 levels	10 levels
Bit password	8 bit	8 bit	8 bit
Pages/help	1024 / 1024	1024 / 1024	1024 / 1024
Variables per page	96	304	320
Variable format	DEC, HEX, BIN, BCD, Floating point	DEC, HEX, BIN, BCD, Floating point	DEC, HEX, BIN, BCD, Floating point
Dynamic texts	Yes	Yes	Yes
Bitmaps	Import option during configuration	Import option during configuration	Import option during configuration
Graphics symbols	Static/dynamic	Static/dynamic	Static/dynamic
Alarms	1024	1024	1024
Messages	1024	1024	1024
Alarm buffer	256	256	256
Recipes [kb]	128	128	128
Trend view	Line or point	Line or point	Line or point
System and function keys	160	304	304
Dimensions			
Height H [mm]	158	260	256
Width W [mm]	210	346	336.3
Depth D [mm]	60	78	50
Weight			
m [kg]	1.3	4.0	1.9

Hand-held





Rated data

Order designation	EPM-H605	EPM-H606 *
		
Display	Graphics, LCD 4 blue scale STN 5.6"	
Type	115.2 x 86.4	
Display size [mm]	Matrix 20 x 16 (16 x 15 pixels each)	
Touchscreen	320 x 240	
Resolution [pixels]	4 x 10/8 x 20/16 x 40	
Lines x characters	8 x 15/ 16 x 30 / 32 x 60	
Text character matrix [pixels]	2.8 x 5.2/5.6 x 10.4/11.2 x 20.8	
Character size [mm]	15000	
Service life of background lighting [h]		
User memory		
Application program	640 kB	
Interfaces		
Serial	RS232	
Fieldbus	CAN system bus	
Clock		
Real-time clock with date	No	
DC supply voltage		
U_{DC} [V]	24 (+18 ... 32)	
Power input		
at 24 V DC [W]	10	
System features	<ul style="list-style-type: none"> ▶ Conformity: Electromagnetic compatibility (89/336/EEC) ▶ Approvals: UL 508, cULus, File No. E189179 ▶ Enclosure: front IP65 ▶ Climatic conditions, permissible humidity: non-condensing, humidity < 85% ▶ Climate requirements: -20 °C ... +60 °C, storage (EN 60721-3-1), -20 °C ... +60 °C transport (EN 60721-3-2), 0 °C ... +50 °C operation (EN 60721-3-3) ▶ Emitted interference EN 61000-6-4 ▶ Immunity to interference EN 61000-6-2 	
Functions		
Online languages	4	
Password	10 levels	
Bit password	8 bit	
Pages/help	128/128	
Variables per page	34	
Variable format	DEC, HEX, BIN, BCD, Floating point	
Dynamic texts	Yes	
Bitmaps	Import option during configuration	
Graphical symbols	Static/dynamic	
Alarms	None	
Messages	256	
Alarm buffer	None	
Recipes [kb]	16	
Trend display	Line or point	
System and function keys	320	
Dimensions		
Height [mm]	H [mm]	
Width [mm]	250	
Depth [mm]	W [mm]	
	222	
	D [mm]	
	97	
Weight		
m [kg]	3.0	





*) with prefabricated plug



Accessories

Item / description:		Order code
 Memory cards	Memory cards can be used to expand the graphics/ project memories of your devices:	
	Memory card 04 4 MB project memory card for the EPM-H410	EPZ-H210
	Flash module 04 4 MB graphics expansion memory card for the EPM-H520	EPZ-H220
	Flash module 08 8 MB project memory card for the EPM-H520 / -H521	EPZ-H221
 Protective foils	Use the protective foils listed below to increase the chemical resistance of the user interface:	
	Protective foil 4 , suitable for the EPM-H502	EPZ-H704
	Protective foil 6 , suitable for the EPM-H505 / -H507/ -H510 and -H515	EPZ-H706
	Protective foil 7 , suitable for the EPM-H605 / -H606	EPZ-H707
 System cables	To enable HMI Designer to be used for multiple applications we can supply the following accessories:	
	Download cable Access via PC to the device's MSP interface.	EPZ-H110
	Adapter fitting Access (together with the download cable) via PC to the device's ASP8 interface.	EPZ-H111
Plug, socket	Plugs and sockets for the system cables of the EPM-H605 and EPM-H606 hand-helds can be ordered separately. In addition, an adapter from 25-pin Sub-D to terminal strip is available for connecting to the control system.	
	Hand-held socket, 26-pin	EPZ-H610
	Hand-held plug, 26-pin	EPZ-H620
 HMI Designer	Uniform visualisation software for creation of HMI applications for the EPM-H series. - Global variables and recipe management - Optimised for Lenze systems - Complete with EPZ-H110 and EPZ-H111 cables	
	Language: German/English	ESP-HMI1-P

System overview

Visualisation system					
System components					
Hardware	HMI		Industrial PC		
	with Windows® CE		Embedded Line	Command Station	Control cabinet PC
Device range					
	EL 100	EPM-H	EL 1800 - EL 9800	CS 5800 - 9800	CPC 2800
Windows® CE					
Runtime software					
L-force Visu					
VisiWinNET® Compact CE	●		●	●	●
Engineering					
Visualisation					
VisiWinNET® Smart	●		●	●	●
VisiWinNET® Professional	●		●	●	●
Communication					
CANopen	●		●	●	●
PROFIBUS / MPI	●		●	●	●
PROFINET (via Ethernet interface)	●		●	●	●
Ethernet	●		●	●	●
Windows® Embedded Standard 2009/ Windows® XP Multilanguage					
Runtime software					
L-force Visu					
VisiWinNET® Compact XP			●	●	●
VisiWinNET® Standard, C/S			●	●	●
Engineering					
Visualisation					
VisiWinNET® Smart			●	●	●
VisiWinNET® Professional			●	●	●
Communication					
PROFIBUS / MPI			●	●	●
PROFINET (via Ethernet interface)			●	●	●
Ethernet			●	●	●
Without Windows® system					
Engineering					
HMI Designer		●			
Communication					
CANopen		●			





Industrial PC

Tailor-made IPC solutions

Introduction	3-2
Embedded Line	3-6
Industrial PC: EL 1800 - 9800	
Command Station	3-16
Industrial PC: CS 5800 - 9800	
Control cabinet PC	3-28
Industrial PC: CPC 2800	3-30
Industrial PC: Controller 3241 C	3-38
Industrial PC: CPC 5100	3-40
Industrial PC: CPC 9100	3-42
Thin Client	3-44
Monitor Panel	3-46
Transmission system	3-48
IPC accessories	3-49

Introduction

Platform strategy



Our philosophy is to provide you with a fast and cost-effective way of achieving a tailor-made IPC solution. Our consistently applied platform strategy makes it possible to configure industrial PC and control solutions individually and ensures almost unlimited scalability in terms of performance, display size, functionality, etc.

IPC platform



- ▶ Computer units
 - Design: built-in panel PC, stand-alone units or control cabinet IPCs
 - Centralised or distributed solutions
- ▶ Operating systems
- ▶ Processor modules
- ▶ Front modules: operating units

Computer units

Designs

Industrial PC		Versions available
	Embedded Line	Panel PC for integration into control cabinet doors, control panels or machine enclosures
	Command Station	Stand-alone terminal with IP65 protection for direct installation in close proximity to machines
	Control cabinet PC	Control cabinet unit for direct installation in plants and machines

Centralised or distributed solution

Solutions		
		Depending on the requirements governing the installation of the industrial PCs, both "central" panel PC solutions and distributed, "separate" solutions are available:
	Centralised solution Industrial PC with display front module	Embedded Lines are compact units combining display, operation and electronics in a common housing.
	Distributed solution Control cabinet PC plus remotely located monitor panel	Distributed solutions consist of separate units: the industrial PC, which is preferably housed in a protected environment in the control cabinet, and the local operating unit. This solution offers advantages in terms of cabling, operating conditions and accessibility of the drives.

Operating systems

Lenze offers a selection of preconfigured operating systems which are specially adapted to industrial PCs. The operating systems are pre-installed and are reproducibly configured and tested, making them very efficient to use.

Microsoft® Windows® and Embedded operating systems

▶ Windows® XP Multilanguage

Plug & play multilingual operating system. Windows® XP Multilanguage comes with the following languages pre-installed: English, German, French, Spanish, Portuguese, Chinese (PRC)

All other languages available from Microsoft for XP can be installed at any time from the DVD supplied.

▶ Windows® Embedded Standard 2009

Windows® Embedded Standard 2009 is the component-based version of Windows® XP Professional, in which the system components necessary for a particular hardware and software configuration can be individually selected.

If suitably configured, Windows® XP Embedded can also be installed on Compact Flash.

▶ Windows® CE 6.0

Windows® CE 6.0 offers real-time capability and is a suitable platform for control tasks and motion control.

Its miniaturised architecture means that the system is easily accommodated on a Compact Flash memory card. It is suitable for implementing rugged systems for operation in close proximity to machines, with the additional benefit that they do not require a fan or hard disk.

Processor modules





Intel Atom processors have been developed specifically for energy-saving systems. They are ideal for use in net tools or in mobile Internet devices, for example, where highly effective power-saving mechanisms are absolutely essential.

Intel® Core™ Duo processors represent a technological breakthrough to even higher performance levels. They form the basis for demanding visualisation solutions with computationally intensive graphics elements.

Front modules

Lenze offers a choice of standard operating units with IP65 protection to cover all requirements.

These front modules comprise a support plate with decorative foil and an integrated industrial TFT display in diagonal screen sizes ranging from 26.4 cm (10.4") to 48.3 cm (19") with analog resistive touch sensor.

	Operating units				
Range of controls	Touchscreen	Touchscreen plus mounting field, 7 control elements and emergency off	Touchscreen plus F/S keys (smart keys)	Touchscreen plus Num, Alpha and F keys	Touchscreen plus Num, special, F keys and MF2 Layout: German or English
Example of front	 EL- / CS- / MP xx00	 CS- / MP xx10	 EL- / MP xx20	 EL- / CS- / MP xx50	 EL- / CS- / MP xx70

Front-face USB socket

An optional USB socket can be fitted on the front face. This does not affect the IP65 enclosure.

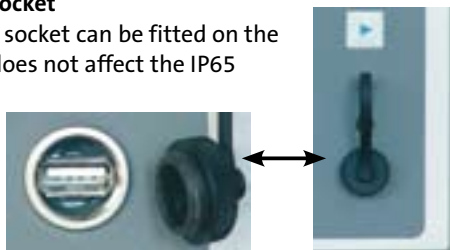

Customised solutions

The design requirements for IPCs and operating panels vary widely in different industry sectors and environmental conditions, and these cannot always be satisfied using standard components. In addition, the operator devices have to fit in with the requirements and design of the customer application.

A consistently applied platform strategy with defined interfaces in electronics and mechanics allows modules to be combined in many different ways. We are therefore able to produce an appropriate system for almost any requirement within a very short space of time.

Here are a few examples of customised systems.

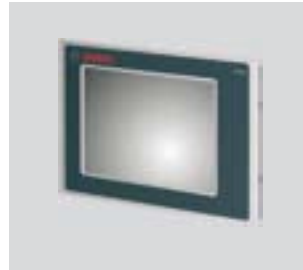

Photo: Bosch Packaging Technology



Photo: Satisloh



Photo: Technotrans



Photo: Monforts



Photo: Monforts



Photo: Vaillant



Photo: Markem-Imaje

In addition to consultancy and the preparation of performance specifications, our services include planning and engineering along with software creation and modification.

Embedded Line

Technology

Embedded Line (EL) industrial PCs are built-in panel PCs for heavy-duty, continuous use in industrial environments. The technology is based on high-performance, low-power processors which offer maximum CPU power combined with very low heat generation. This is the secret behind the compact dimensions and rugged, fanless design of Embedded Line IPCs.

Alongside the thermal design, other criteria for long-lasting, trouble-free operation under harsh industrial conditions include the choice of components and immunity to electromagnetic interference.

To ensure the availability and security of investment of our systems, we only use chipsets with long-term availability and CPUs from reputable manufacturers.

Installation

Embedded Line industrial PCs are designed to be installed in control cabinets, machine enclosures and other mounting cutouts. They feature bolts and clamping screws on the rear face to allow easy installation and secure sealing (IP65) even in harsh industrial environments.

Equipment

All Embedded Line industrial PCs feature Ethernet as well as USB and serial RS232 interfaces. They all include a slot for Compact Flash cards.





A USB connection on the front face with an IP65 cover allows fast and easy connection of peripherals, for servicing requirements for example.

Optional extras include a UPS (uninterruptible power supply) or alternatively a maintenance-free capacitor UPS (CAPS) for data backup (remanence) or for shutting down the system in the event of a power failure.



Front modules

Design, range of controls, front dimensions and display data

Front modules	Device designation	Dimensions mm (W x H) ¹⁾	Diagonal	Brightness (cd/m ²)	Resolution	MTBF (h)	Range of controls
Touchscreen 	▶ EL 1800	325 x 240	26.4 cm (10.4")	400	640 x 480	40,000	Front face, 4 keys for system control: ▶ 3 freely assignable keys (F1-F3) ▶ "Service Mode" key for adjusting the display brightness to the surroundings and for increasing the service life of the display (backlighting).
	▶ EL 1800s	325 x 240	26.4 cm (10.4")	350	800 x 600	50,000	
	▶ EL 2800	390 x 300	30.7 cm (12.1")	300	800 x 600	50,000	
	▶ EL 5800	450 x 325	38.1 cm (15")	250	1024 x 768	50,000	
	▶ EL 9800	490 x 400	48.3 cm (19")	300	1280 x 1024	50,000	
Touchscreen plus F/S keys (smart keys) 	▶ EL 5820	483 x 310 19" / 7 HE	38.1 cm (15")	250	1024 x 768	50,000	▶ F1...F12 ▶ S1...S14 (smart keys) ▶ ESC ▶ Enter ▶ Alternative labelling for S1...S14
Touchscreen plus Num, Alpha and F keys 	▶ EL 1850	365 x 240	26.4 cm (10.4")	400	640 x 480	40,000	<i>Multiple assignment:</i> ▶ A...Z ▶ Ctrl ▶ TAB ▶ Shift ▶ + - , ; \ characters ▶ 0...9 ▶ Alt ▶ Home ▶ Enter ▶ F1...F12 ▶ Del ▶ End ▶ Alpha level switching ▶ Cursor keys ▶ Space ▶ Ins ▶ PgUp ▶ Backspace ▶ ESC ▶ PgDn ▶ Print
	▶ EL 1850s	365 x 240	26.4 cm (10.4")	350	800 x 600	50,000	
	▶ EL 2850	425 x 310	30.7 cm (12.1")	300	800 x 600	50,000	
	▶ EL 5850	483 x 310 19" / 7 HE	38.1 cm (15")	250	1024 x 768	50,000	
Touchscreen plus Num, special, F keys and MF2 	▶ EL 5870	483 x 399 19" / 9 HE	38.1 cm (15")	250	1024 x 768	50,000	<i>(as above: "Touchscreen plus Num, Alpha, F keys" version)</i> plus ▶ MF2 operator keyboard, layout: German or English

¹⁾ The mounting depth depends on the device type and equipment

System features



Applications

- ▶ Industrial PC for control and visualisation
- ▶ Automation system for machines in the production process: visualisation, PLC and motion control in a single system
- ▶ Plant control, visualisation, measurement and analysis data, PDA system, web terminal and much more: applications for operations in close proximity to machines

Industrial TFT displays	26.4 cm (10.4") to 48.3 cm (19") with resistive touchscreen
Extendable by means of option cards	<ul style="list-style-type: none"> ▶ MC-ETH Ethernet 100/ 1000 MBit ▶ MC-PBM PROFIBUS Master ▶ MC-CAN2 2-way CAN ▶ MC-MPI MPI/PROFIBUS ▶ MC-ISI serial RS232/RS422/RS485
Interfaces	1 x Ethernet 10/100 MBit, 3 x USB 2.0 on rear, 1 x USB 2.0 for front module, 1 x PS/2 mouse + keyboard (combined), 1 x serial interface RS232
Cooling	<ul style="list-style-type: none"> ▶ Passive via heatsink: Atom 1,6 GHz ▶ Smart Cool: Thermostatically controlled fan with double ball race and function monitoring, MTBF 280,000 h
Operating systems	<ul style="list-style-type: none"> ▶ Microsoft® Windows® CE 6.0 for L-force runtime software ▶ Microsoft® Windows® Embedded Standard 2009 ▶ Microsoft® Windows® XP Multilanguage
Mass storage	<ul style="list-style-type: none"> ▶ Standard: Slot for external Compact Flash memory card ▶ Option: SATA hard disk (Standard: >= 160 GB, Extended: >= 80 GB for extended temperature range and continuous operation) ▶ Option: DVD writer drive (on rear face)
Voltage supply	<ul style="list-style-type: none"> ▶ 24 V DC ± 25 % ▶ Option: Integrated UPS module for external battery or (CAPS) capacitor pack (External battery/capacitor packs are accessories and must be ordered separately).
General technical data	<ul style="list-style-type: none"> ▶ Approval: UL 508, CSA C22.2, CE, EN 61000 6-2(4), EN 55022, EN 55024 ▶ Enclosure: front IP65, rear IP20 ▶ Temperature range: max. 0 to 50°C operation, -10 to 60°C storage ▶ Relative humidity: 10 to 90%, non-condensing ▶ Maximum altitude: 3000 m above sea level

Control and visualisation under Windows® CE 6.0



Standard equipment

- ▶ Display: analog resistive touchscreen
- ▶ Operating system: Windows® CE 6.0
- ▶ Processor: Intel Atom 1.6 GHz
- ▶ Main memory: >= 1024 MB
- ▶ Memory card: Compact Flash >= 512 MB
- ▶ ACU UPS Control Unit for connecting an external CAPS capacitor pack for data remanence

Versions		Order code															
EL1800	26.4 cm (10.4") TFT display, 640x480 Standard (4 F keys)	EP8GAP	3	<input type="checkbox"/>	<input type="checkbox"/>	00C40	<input type="checkbox"/>	<input type="checkbox"/>	XX-	0	1	C34	<input type="checkbox"/>	<input type="checkbox"/>	<input type="checkbox"/>	000	
EL1850	Num, Alpha, F keys			1													
EL1800S	26.4 cm (10.4") TFT display, 800x600 Standard (4 F keys)	EP8GAP	4	<input type="checkbox"/>	<input type="checkbox"/>	00C40	<input type="checkbox"/>	<input type="checkbox"/>	XX-	0	1	C34	<input type="checkbox"/>	<input type="checkbox"/>	<input type="checkbox"/>	000	
EL1850S	Num, Alpha, F keys			1													
EL2800	30.7 cm (12.1") TFT display, 800x600 Standard (4 F keys)	EP8GAP	5	<input type="checkbox"/>	<input type="checkbox"/>	00C40	<input type="checkbox"/>	<input type="checkbox"/>	XX-	0	1	C34	<input type="checkbox"/>	<input type="checkbox"/>	<input type="checkbox"/>	000	
EL2850	Num, Alpha, F keys			1													
EL5800	38.1 cm (15") TFT display, 1024x768 Standard (4 F keys)	EP8GAP	6	<input type="checkbox"/>	<input type="checkbox"/>	00C40	<input type="checkbox"/>	<input type="checkbox"/>	XX-	0	1	C34	<input type="checkbox"/>	<input type="checkbox"/>	<input type="checkbox"/>	000	
EL5820	F/S keys			1													
EL5850	Num, Alpha, F keys			4													
EL5870	Num, special, F keys, MF2 English			5													
EL9800	48.3 cm (19") TFT display, 1280x1024 Standard (4 F keys)	EP8GAP	7	1	<input type="checkbox"/>	00C40	<input type="checkbox"/>	<input type="checkbox"/>	XX-	0	1	C34	<input type="checkbox"/>	<input type="checkbox"/>	<input type="checkbox"/>	000	
				1													
Additional equipment																	
Front design																	
without front-face USB socket					3												
with front-face USB socket					4												
Option interface MC 1																	
Option interface MC 2																	
none						0	0										
MC-ETH						1	1										
MC-PBM						5	5										
MC-CAN2						9	9										
MC-ISI						D	D										
Runtime control technology																	
L-force Logic: LPC 1000													1				
L-force Motion: MPC 1200													2				
Runtime visualisation																	
none													0	0			
L-force Visu: VisiWinNET Compact CE		(max. 2000 power tags)											1				
50 power tags														1			
100 power tags														2			
250 power tags														3			
500 power tags														4			
1000 power tags														5			
2000 power tags														6			

Visualisation under Windows® CE 6.0



Windows® CE6.0

Standard equipment

- ▶ Display: analog resistive touchscreen
- ▶ Operating system: Windows® CE 6.0
- ▶ Processor: Intel Atom 1.6 GHz
- ▶ Main memory: >= 1024 MB
- ▶ Memory card: Compact Flash >= 512 MB

3

Versions		Order code														
EL1800	26.4 cm (10.4") TFT display, 640x480	EP8GAP	3	<input type="checkbox"/>	<input type="checkbox"/>	00C40	<input type="checkbox"/>	<input type="checkbox"/>	XX-	0	<input type="checkbox"/>	C340	1	<input type="checkbox"/>	000	
	Standard (4 F keys)															
EL1850	Num, Alpha, F keys															
EL1850S	26.4 cm (10.4") TFT display, 800x600	EP8GAP	4	<input type="checkbox"/>	<input type="checkbox"/>	00C40	<input type="checkbox"/>	<input type="checkbox"/>	XX-	0	<input type="checkbox"/>	C340	1	<input type="checkbox"/>	000	
	Standard (4 F keys)															
EL1850S	Num, Alpha, F keys															
EL2800	30.7 cm (12.1") TFT display, 800x600	EP8GAP	5	<input type="checkbox"/>	<input type="checkbox"/>	00C40	<input type="checkbox"/>	<input type="checkbox"/>	XX-	0	<input type="checkbox"/>	C340	1	<input type="checkbox"/>	000	
	Standard (4 F keys)															
EL2850	Num, Alpha, F keys															
EL5800	38.1 cm (15") TFT display, 1024x768	EP8GAP	6	<input type="checkbox"/>	<input type="checkbox"/>	00C40	<input type="checkbox"/>	<input type="checkbox"/>	XX-	0	<input type="checkbox"/>	C340	1	<input type="checkbox"/>	000	
	Standard (4 F keys)															
	EL5820	F/S keys														
	EL5850	Num, Alpha, F keys														
	EL5870	Num, special, F keys, MF2 English														
EL9800	48.3 cm (19") TFT display, 1280x1024	EP8GAP	7	<input type="checkbox"/>	<input type="checkbox"/>	00C40	<input type="checkbox"/>	<input type="checkbox"/>	XX-	0	<input type="checkbox"/>	C340	1	<input type="checkbox"/>	000	
EL9800	Standard (4 F keys)															
Additional equipment																
Front design																
without front-face USB socket																
with front-face USB socket			3													
Option interface MC 1																
Option interface MC 2																
none							0	0								
MC-ETH							1	1								
MC-CAN2							9	9								
MC-MPI							C	C								
MC-ISI							D	D								
UPS																
none													0			
ACU UPS Control Unit													1			
Runtime visualisation																
L-force Visu: VisiWinNET Compact CE																
50 power tags																1
100 power tags																2
250 power tags																3
500 power tags																4
1000 power tags																5
2000 power tags																6

Industrial PC

Embedded Line EL 1800 – 9800

Versions	Order code														
↓ Continued overleaf									↓	↓	↓			↓	↓
External memory card															
none									0	0					
Compact Flash >= 4 GB									C	6					
Compact Flash >= 8 GB									C	7					
Operating system															
Windows® Embedded Standard 2009															
on memory card												5			
on hard disk												6			
Runtime visualisation															
L-force Visu:															
VisiWinNET Compact XP	(max. 2000 power tags)													1	
VisiWinNET Standard XP	(min. 250 power tags)													2	
50 power tags															1
100 power tags															2
250 power tags															3
500 power tags															4
1000 power tags															5
2000 power tags															6
4000 power tags															7
64000 power tags															8

Visualisation under Windows® XP Multilanguage



Windows® XP Multilanguage

Standard equipment

- ▶ Display: analog resistive touchscreen
- ▶ Operating system: Windows® XP Multilanguage

Versions		Order code																		
EL1800	26.4 cm (10.4") TFT display, 640x480	EP 8 G A P	3	<input type="checkbox"/>	<input type="checkbox"/>	0 0	<input type="checkbox"/>	<input type="checkbox"/>	<input type="checkbox"/>	<input type="checkbox"/>	<input type="checkbox"/>	XX -	<input type="checkbox"/>	<input type="checkbox"/>	0 0 7 0	<input type="checkbox"/>	<input type="checkbox"/>	0 0 0		
	Standard (4 F keys)		1																	
EL1850	Num, Alpha, F keys		5																	
EL1800S	26.4 cm (10.4") TFT display, 800x600	EP 8 G A P	4	<input type="checkbox"/>	<input type="checkbox"/>	0 0	<input type="checkbox"/>	<input type="checkbox"/>	<input type="checkbox"/>	<input type="checkbox"/>	<input type="checkbox"/>	XX -	<input type="checkbox"/>	<input type="checkbox"/>	0 0 7 0	<input type="checkbox"/>	<input type="checkbox"/>	0 0 0		
	Standard (4 F keys)		1																	
EL1850S	Num, Alpha, F keys		5																	
EL2800	30.7 cm (12.1") TFT display, 800x600	EP 8 G A P	5	<input type="checkbox"/>	<input type="checkbox"/>	0 0	<input type="checkbox"/>	<input type="checkbox"/>	<input type="checkbox"/>	<input type="checkbox"/>	<input type="checkbox"/>	XX -	<input type="checkbox"/>	<input type="checkbox"/>	0 0 7 0	<input type="checkbox"/>	<input type="checkbox"/>	0 0 0		
	Standard (4 F keys)		1																	
EL2850	Num, Alpha, F keys		5																	
EL5800	38.1 cm (15") TFT display, 1024x768	EP 8 G A P	6	<input type="checkbox"/>	<input type="checkbox"/>	0 0	<input type="checkbox"/>	<input type="checkbox"/>	<input type="checkbox"/>	<input type="checkbox"/>	<input type="checkbox"/>	XX -	<input type="checkbox"/>	<input type="checkbox"/>	0 0 7 0	<input type="checkbox"/>	<input type="checkbox"/>	0 0 0		
	Standard (4 F keys)		1																	
	EL5820	F/S keys		4																
	EL5850	Num, Alpha, F keys		5																
	EL5870	Num, special, F keys, MF2 German		6																
	EL5870	Num, special, F keys, MF2 English		7																
EL9800	48.3 cm (19") TFT display, 1280x1024	EP 8 G A P	7	1	<input type="checkbox"/>	0 0	<input type="checkbox"/>	<input type="checkbox"/>	<input type="checkbox"/>	<input type="checkbox"/>	<input type="checkbox"/>	XX -	<input type="checkbox"/>	<input type="checkbox"/>	0 0 7 0	<input type="checkbox"/>	<input type="checkbox"/>	0 0 0		
	Standard (4 F keys)		1																	
Additional equipment																				
Front design																				
without front-face USB socket			3																	
with front-face USB socket			4																	
Processor																				
Intel Atom 1.6 GHz (fanless)																		C		
Intel Core Duo 1.66 GHz (smart cool)																			9	
Main memory																				
>= 1024 MB																			4	
>= 2048 MB ¹⁾																			5	
Mass storage, internal																				
Hard disk, standard																			3	
Hard disk, extended																			1	
Option interface MC 1																				
Option interface MC 2																				
none																			0 0	
MC-ETH																			1 1	
MC-CAN2																			9 9	
MC-MPI																			C C	
MC-ISI																			D D	
DVD unit																				
none																			0	
DVD writer drive																			1	
UPS																				
none																			0	
ACU UPS Control Unit																			1	
Runtime visualisation																				
L-force Visu: VisiWinNET Compact XP		(max. 2000 power tags)																	1	
L-force Visu: VisiWinNET Standard XP		(min. 250 power tags)																	2	
50 power tags																			1	
100 power tags																			2	
250 power tags																			3	
500 power tags																			4	
1000 power tags																			5	
2000 power tags																			6	
4000 power tags																			7	
64000 power tags																			8	

¹⁾ Only configurable with Core Duo processor.

IPC under Windows® XP Multilanguage
alternative without operating system



Windows® XP Multilanguage

Standard equipment

- ▶ Display: analog resistive touchscreen
- ▶ Operating system: Windows® XP Multilanguage

Versions		Order code																	
EL1800	26.4 cm (10.4") TFT display, 640x480	E P 8 G A P	3	<input type="checkbox"/>	<input type="checkbox"/>	00	<input type="checkbox"/>	<input type="checkbox"/>	<input type="checkbox"/>	<input type="checkbox"/>	<input type="checkbox"/>	XX-	<input type="checkbox"/>	<input type="checkbox"/>	00	<input type="checkbox"/>	000	000	
	Standard (4 F keys)		1																
EL1850	Num, Alpha, F keys		5																
EL1800S	26.4 cm (10.4") TFT display, 800x600	E P 8 G A P	4	<input type="checkbox"/>	<input type="checkbox"/>	00	<input type="checkbox"/>	<input type="checkbox"/>	<input type="checkbox"/>	<input type="checkbox"/>	<input type="checkbox"/>	XX-	<input type="checkbox"/>	<input type="checkbox"/>	00	<input type="checkbox"/>	000	000	
	Standard (4 F keys)		1																
EL1850S	Num, Alpha, F keys		5																
EL2800	30.7 cm (12.1") TFT display, 800x600	E P 8 G A P	5	<input type="checkbox"/>	<input type="checkbox"/>	00	<input type="checkbox"/>	<input type="checkbox"/>	<input type="checkbox"/>	<input type="checkbox"/>	<input type="checkbox"/>	XX-	<input type="checkbox"/>	<input type="checkbox"/>	00	<input type="checkbox"/>	000	000	
	Standard (4 F keys)		1																
EL2850	Num, Alpha, F keys		5																
EL5800	38.1 cm (15") TFT display, 1024x768	E P 8 G A P	6	<input type="checkbox"/>	<input type="checkbox"/>	00	<input type="checkbox"/>	<input type="checkbox"/>	<input type="checkbox"/>	<input type="checkbox"/>	<input type="checkbox"/>	XX-	<input type="checkbox"/>	<input type="checkbox"/>	00	<input type="checkbox"/>	000	000	
	Standard (4 F keys)		1																
	EL5820	F/S keys		4															
	EL5850	Num, Alpha, F keys		5															
	EL5870	Num, special, F keys, MF2 German		6															
EL5870	Num, special, F keys, MF2 English		7																
EL9800	48.3 cm (19") TFT display, 1280x1024	E P 8 G A P	7	1	<input type="checkbox"/>	00	<input type="checkbox"/>	<input type="checkbox"/>	<input type="checkbox"/>	<input type="checkbox"/>	<input type="checkbox"/>	XX-	<input type="checkbox"/>	<input type="checkbox"/>	00	<input type="checkbox"/>	000	000	
	Standard (4 F keys)		1																
Additional equipment																			
Front design																			
without front-face USB socket			3																
with front-face USB socket			4																
Processor																			
Intel Atom 1.6 GHz (fanless)																			C
Intel Core Duo 1.66 GHz (smart cool)																			9
Main memory																			
>= 1024 MB																			4
>= 2048 MB ¹⁾																			5
Mass storage, internal																			
Hard disk, standard																			3
Hard disk, extended																			1
Option interface MC 1																			
Option interface MC 2																			
none																			0
MC-ETH																			1
MC-CAN2 with PCAN Light licence																			B
MC-ISI																			D
DVD unit																			
none																			0
DVD writer drive																			1
UPS																			
none																			0
ACU UPS Control Unit																			1
Operating system																			
none																			0
Windows® XP Multilanguage																			7

¹⁾ Only configurable with Core Duo processor.

Command Station

Description

The Command Station (CS) is a stand-alone operator station with all-round protection against dust and water spray (IP65) in an attractive designer housing. The flat housing is machined from solid aluminium with a stainless steel mounting frame at the rear for support arm mounting or direct wall mounting.

For the flexible implementation of individual operating concepts the system offers numerous options and extension consoles, including touchscreen, function and alphanumeric keyboards, operator consoles with switching elements or MF2 keyboards in various designs.

Command Station versions

- ▶ Panel industrial PC
- ▶ Thin client
- ▶ DVI monitor panel

Application areas





With its attractive housing design, high-quality processing, flexible mounting options and easy implementation of customised input concepts, the Command Station is a flexible operating concept for a wide variety of applications, including

- ▶ Machine control
- ▶ IPC in production areas
- ▶ Industrial equipment in the chemical industry
- ▶ PDA, DNC applications
- ▶ CNC machine tools
- ▶ Airports, railway stations, information terminals
- ▶ Building services control systems
- ▶ Control stations, information points, test benches
- ▶ Access control systems



Front modules

Design, range of controls, front dimensions and display data

Front modules	Device designation	Dimensions mm (W x H x D)	Diagonal	Brightness (cd/m ²)	Resolution	MTBF (h)	Range of controls
Touchscreen 	▶ CS 5800	466 x 335 x 68	38.1 cm (15")	250	1024 x 768	50,000	Front face, 4 keys for system control: ▶ 3 freely assignable keys (F1-F3) ▶ "Service Mode" key for adjusting the display brightness to the surroundings and for increasing the service life of the display (backlighting).
	▶ CS 9800	506 x 410 x 78	48.3 cm (19")	300	1280 x 1024	50,000	
Touchscreen plus mounting field, 7 control elements and emergency off 	▶ CS 5810	466 x 430 x 78	38.1 cm (15")	250	1024 x 768	50,000	<i>as above: "Touchscreen" version plus</i> ▶ Mounting area for 7 control/switching elements (Ø 22.5 mm), installation as per EN 60947-5-1, D22 ▶ Emergency off
Touchscreen plus Num, Alpha and F keys 	▶ CS 5850	500 x 330 x 68	38.1 cm (15")	250	1024 x 768	50,000	<i>Multiple assignment:</i> ▶ A...Z ▶ Ctrl ▶ TAB ▶ Shift ▶ + - , ; \ characters ▶ 0...9 ▶ Alt ▶ Home ▶ Enter ▶ F1...F12 ▶ Del ▶ End ▶ Alpha level switching ▶ Cursor keys ▶ Space ▶ Ins ▶ PgUp ▶ Backspace ▶ ESC ▶ PgDn ▶ Print
Touchscreen plus Num, special, F keys and MF2 	▶ CS 5870	499 x 410 x 78	38.1 cm (15")	250	1024 x 768	50,000	<i>(as above: "Touchscreen plus Num, Alpha, F keys" version)</i> plus ▶ MF2 operator keyboard, layout: German or English

Modular assembly

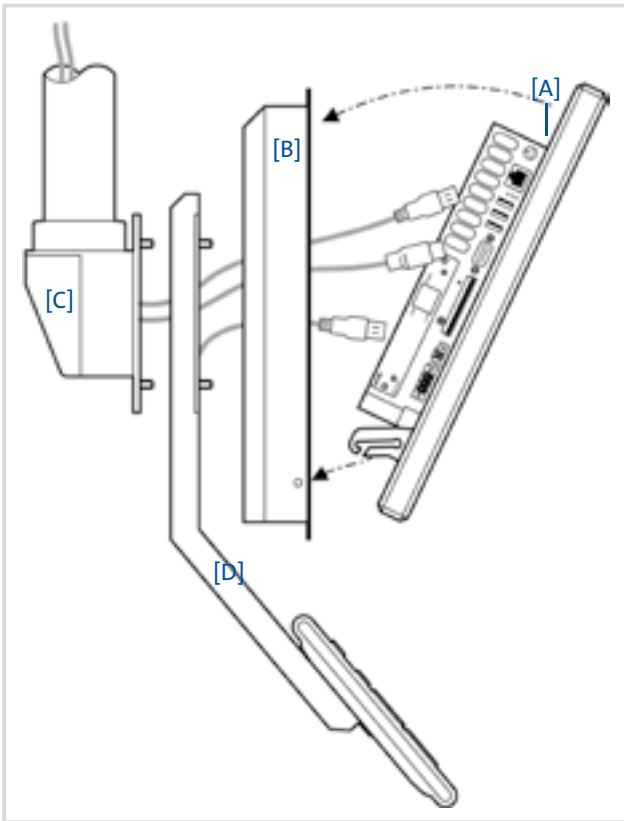

[A] **Front module**

The detachable front module (aluminium) with PC unit [A] combined with a fixed mounting frame (stainless steel) [B] makes for simple installation and wiring and allows easy access for maintenance when required.

[B] **Mounting frame**

with optional cable entries in the housing base

- ▶ Universal double cable entry point (KDL 2)
- ▶ USB connection with IP65 cap
- ▶ Connection plate (customised)

[C] **Installation, adapter**

A choice of suitable fixing adapters is available for the various mounting systems.

- ▶ VESA adapter / wall bracket
- ▶ Rittal CP-L support arm and accessories

[D] **Extension console**

in stainless steel for the optional addition of extra keyboards and control elements.

- ▶ For add-on components see overleaf

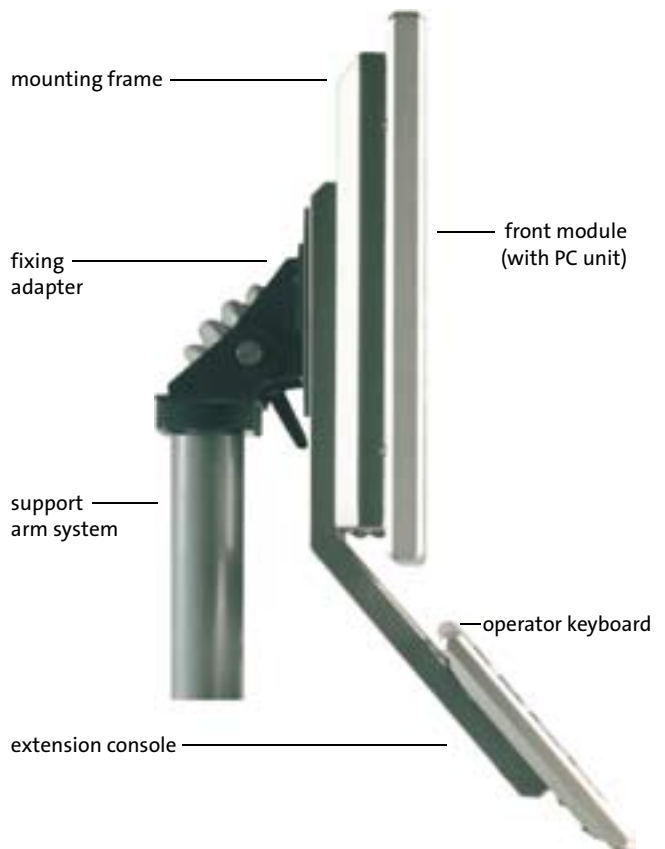

Add-on components



Operator console CSB 7 or CSB 14

Operator console with 7 or 14 switching elements and emergency off

- ▶ Switching elements can be labelled with labelling strips
- ▶ Switching level/illumination
 - CSB 7: 2 switching levels per switching element and illumination possible
 - CSB 14: 1 switching level per switching element and illumination possible
- ▶ Direct cabling into the CS housing

Additional keyboards and control elements can easily be connected to the Command Station by means of extension consoles.

- ▶ MF2 keyboard in stainless steel (IP65)
- ▶ Operator console with 7 or 14 control elements and emergency off
- ▶ Customised versions



MF2 keyboard in stainless steel (IP65)

CSB MF2 E - MF2 stainless steel keyboard

MF2 keyboard with long-stroke keys in stainless steel, enclosure IP65

- ▶ USB interface
- ▶ Direct cabling into CS housing, internal

Order data

Add-on components			Order code
	CSB 7	Fully prepared for mounting of elements, excluding switching contacts and control elements, including extension console	EPCZEBT7
	CSB 14	Fully prepared for mounting of elements, excluding switching contacts and control elements, including extension console	EPCZEBT4
	CSB MF2 E	MF2 keyboard in stainless steel with NUM block (IP65) including extension console	EPCZEBTA □□
		MF2 keyboard in stainless steel with touch pad (IP65) including extension console	EPCZEBTT □□
		MF2 keyboard in stainless steel (IP65) with trackball (IP54) including extension console	EPCZEBTB □□
Country versions	German English French US Other versions available on request		DE GB FR US
Order code	Your solution:		EPCZEBT □ □ □

System features



Applications

- ▶ Attractive aluminium operator housing, IP65 enclosure, extendable operator consoles with control elements
- ▶ Industrial PC for control and visualisation
- ▶ Automation system for machines in the production process: visualisation, PLC and motion control in a single system
- ▶ Machine operation, controls, web terminal, applications under Windows® CE, measurement and control tasks

Industrial TFT displays	38.1 cm (15") to 48.3 cm (19") with resistive touchscreen
Extendable by means of option cards	<ul style="list-style-type: none"> ▶ MC-ETH Ethernet 100/ 1000 MBit ▶ MC-PBM PROFIBUS Master ▶ MC-CAN2 2-way CAN ▶ MC-MPI MPI/PROFIBUS ▶ MC-ISI serial RS232/RS422/RS485
Interface	Internal: 1 x Ethernet 10/100 MBit, 3 x USB 2.0 on rear, 1 x PS/2 mouse + keyboard (combined), 1 x serial interface RS232 External: 1 x USB 2.0 for front module, 1 x USB 2.0 in mounting frame IP65
Cooling	▶ Smart Cool: Fan with double ball race and function monitoring, MTBF 280,000 h
Operating systems	<ul style="list-style-type: none"> ▶ Microsoft® Windows® CE 6.0 for L-force runtime software ▶ Microsoft® Windows® Embedded Standard 2009 ▶ Microsoft® Windows® XP Multilanguage
Mass storage	<ul style="list-style-type: none"> ▶ Standard: Slot for external Compact Flash memory card ▶ Option: SATA hard disk (standard: >= 160 GB, extended: >= 80 GB for extended temperature range and continuous operation)
Voltage supply	<ul style="list-style-type: none"> ▶ 24 V DC ± 25 % ▶ Option: Integrated UPS module for external battery or (CAPS) capacitor pack (External battery/capacitor packs are accessories and must be ordered separately).
General technical data	<ul style="list-style-type: none"> ▶ Approval: UL 508 (recognised), CSA C22.2 (recognised), CE, EN 61000 6-2(4), EN 55022, EN 55024 ▶ Enclosure: IP65 ▶ Temperature range: max. 0 to 45°C operation, -10 to 60°C storage ▶ Relative humidity: 10 to 90%, non-condensing ▶ Maximum altitude: 3000 m above seal level

Control and visualisation under Windows® CE 6.0



Windows® CE6.0

Standard equipment

- ▶ Display: analog resistive touchscreen
- ▶ Operating system: Windows® CE 6.0
- ▶ Processor: Intel Atom 1.6 GHz
- ▶ Main memory: >= 1024 MB
- ▶ Memory card: Compact Flash >= 512 MB
- ▶ ACU UPS Control Unit for connecting an external CAPS capacitor pack for data remanence

	Versions	Order code
	38.1 cm (15") TFT display, 1024x768	EP8GAS 6 <input type="checkbox"/> <input type="checkbox"/> <input type="checkbox"/> <input type="checkbox"/> <input type="checkbox"/> <input type="checkbox"/> C40 <input type="checkbox"/> XXX - 0 1 C34 <input type="checkbox"/> <input type="checkbox"/> <input type="checkbox"/> 000
CS5800	Standard (4 F keys)	1
CS5810	Mounting field, 7 control elements and emergency off	2
CS5850	Num, Alpha, F keys	5
CS5870	Num, special, F keys, MF2 English	7
	48.3 cm (19") TFT display, 1280x1024	EP8GAS 7 <input type="checkbox"/> <input type="checkbox"/> <input type="checkbox"/> <input type="checkbox"/> <input type="checkbox"/> <input type="checkbox"/> C40 <input type="checkbox"/> XXX - 0 1 C34 <input type="checkbox"/> <input type="checkbox"/> <input type="checkbox"/> 000
CS9800	Standard (4 F keys)	1
	Additional equipment	
	Front design	
	without front-face USB socket	3
	with front-face USB socket	4
	Mounting frame	
	No cable gland	0
	Universal double cable entry point (KDL-2)	1
	1 x USB connection in mounting frame IP65	3
	2 x USB connection in mounting frame IP65	4
	Fixing adapter	
	VESA 100	1
	VESA closed	2
	Rittal CP-L	3
	Option interface MC 1	
	none	0
	MC-ETH	1
	MC-PBM	5
	MC-CAN2	9
	MC-ISI	D
	Runtime control technology	
	L-force Logic: LPC 1000	1
	L-force Motion: MPC 1200	2
	Runtime visualisation	
	none	0 0
	L-force Visu: VisiWinNET Compact CE (max. 2000 power tags)	1
	50 power tags	1
	100 power tags	2
	250 power tags	3
	500 power tags	4
	1000 power tags	5
	2000 power tags	6

Visualisation under Windows® CE 6.0



Windows® CE6.0

Standard equipment

- ▶ Display: analog resistive touchscreen
- ▶ Operating system: Windows® CE 6.0
- ▶ Processor: Intel Atom 1.6 GHz
- ▶ Main memory: >= 1024 MB
- ▶ Memory card: Compact Flash >= 512 MB

3

Versions		Order code																				
	38.1 cm (15") TFT display, 1024x768	E	P	8	G	A	S	6	<input type="checkbox"/>	<input type="checkbox"/>	<input type="checkbox"/>	<input type="checkbox"/>	C40	<input type="checkbox"/>	XXX-	0	<input type="checkbox"/>	C340	1	<input type="checkbox"/>	000	
CS5800	Standard (4 F keys)							1														
CS5810	Mounting field, 7 control elements and emergency off							2														
CS5850	Num, Alpha, F keys							5														
CS5870	Num, special, F keys, MF2 English							7														
	48.3 cm (19") TFT display, 1280x1024	E	P	8	G	A	S	7	1	<input type="checkbox"/>	<input type="checkbox"/>	<input type="checkbox"/>	C40	<input type="checkbox"/>	XXX-	0	<input type="checkbox"/>	C340	1	<input type="checkbox"/>	000	
CS9800	Standard (4 F keys)							1														
Additional equipment																						
Front design																						
	without front-face USB socket																					3
	with front-face USB socket																					4
Mounting frame																						
	No cable gland																					0
	Universal double cable entry point (KDL-2)																					1
	1 x USB connection in mounting frame IP65																					3
	2 x USB connection in mounting frame IP65																					4
Fixing adapter																						
	VESA 100																					1
	VESA closed																					2
	Rittal CP-L																					3
Option interface MC 1																						
	none																					0
	MC-ETH																					1
	MC-CAN2																					9
	MC-MPI																					C
	MC-ISI																					D
UPS																						
	none																					0
	ACU UPS Control Unit																					1
Runtime visualisation																						
	L-force Visu: VisiWinNET Compact CE	(max. 2000 power tags)																				
	50 power tags																					1
	100 power tags																					2
	250 power tags																					3
	500 power tags																					4
	1000 power tags																					5
	2000 power tags																					6

Visualisation under Windows® Embedded Standard 2009



Windows® Embedded Standard 2009

Standard equipment

- ▶ Display: analog resistive touchscreen
- ▶ Operating system: Windows® Embedded Standard 2009
- ▶ Processor: Intel Atom 1.6 GHz
- ▶ Main memory: >= 1024 MB

Versions	Order code
CS5800	EP 8 G A S 6 <input type="checkbox"/> <input type="checkbox"/> <input type="checkbox"/> <input type="checkbox"/> C4 <input type="checkbox"/> <input type="checkbox"/> X X X - 0 <input type="checkbox"/> <input type="checkbox"/> <input type="checkbox"/> <input type="checkbox"/> 0 <input type="checkbox"/> <input type="checkbox"/> <input type="checkbox"/> 0 0 0
CS5810	1
Standard (4 F keys)	2
CS5850	5
CS5870	6
CS5870	7
CS9800	EP 8 G A S 7 1 <input type="checkbox"/> <input type="checkbox"/> <input type="checkbox"/> C4 <input type="checkbox"/> <input type="checkbox"/> X X X - 0 <input type="checkbox"/> <input type="checkbox"/> <input type="checkbox"/> <input type="checkbox"/> 0 <input type="checkbox"/> <input type="checkbox"/> <input type="checkbox"/> 0 0 0
Standard (4 F keys)	1
Additional equipment	
Front design	
without front-face USB socket	3
with front-face USB socket	4
Mounting frame	
No cable gland	0
Universal double cable entry point (KDL-2)	1
1 x USB connection in mounting frame IP65	3
2 x USB connection in mounting frame IP65	4
Fixing adapter	
VESA 100	1
VESA closed	2
Rittal CP-L	3
Mass storage, internal	
none	0
Hard disk, standard	3
Hard disk, extended	1
Option interface MC 1	
none	0
MC-ETH	1
MC-CAN2	9
MC-MPI	C
MC-ISI	D
UPS	
none	0
ACU UPS Control Unit	1
External memory card	
none	0 0
Compact Flash >= 4 GB	C 6
Compact Flash >= 8 GB	C 7
Operating system	
Windows® Embedded Standard 2009	
on memory card	5
on hard disk	6
Runtime visualisation	
L-force Visu: VisiWinNET Compact XP (max. 2000 power tags)	1
L-force Visu: VisiWinNET Standard XP (min. 250 power tags)	2
50 power tags	1
100 power tags	2
250 power tags	3
500 power tags	4
1000 power tags	5
2000 power tags	6
4000 power tags	7
64000 power tags	8

Visualisation under Windows® XP Multilanguage



Windows® XP Multilanguage

Standard equipment

- ▶ Display: analog resistive touchscreen
- ▶ Operating system: Windows® XP Multilanguage
- ▶ Processor: Intel Atom 1.6 GHz
- ▶ Main memory: >= 1024 MB

3

Versions		Order code																	
	38.1 cm (15") TFT display, 1024x768	EP8GAS	6	<input type="checkbox"/>	<input type="checkbox"/>	<input type="checkbox"/>	<input type="checkbox"/>	<input type="checkbox"/>	C4	<input type="checkbox"/>	<input type="checkbox"/>	XXX-	0	<input type="checkbox"/>	0070	<input type="checkbox"/>	<input type="checkbox"/>	000	
CS5800	Standard (4 F keys)		1																
CS5810	Mounting field, 7 control elements and emergency off		2																
CS5850	Num, Alpha, F keys		5																
CS5870	Num, special, F keys, MF2 German		6																
CS5870	Num, special, F keys, MF2 English		7																
	48.3 cm (19") TFT display, 1280x1024	EP8GAS	7	1	<input type="checkbox"/>	<input type="checkbox"/>	<input type="checkbox"/>	<input type="checkbox"/>	C4	<input type="checkbox"/>	<input type="checkbox"/>	XXX-	0	<input type="checkbox"/>	0070	<input type="checkbox"/>	<input type="checkbox"/>	000	
CS9800	Standard (4 F keys)		1																
Additional equipment																			
Front design																			
without front-face USB socket			3																
with front-face USB socket			4																
Mounting frame																			
No cable gland			0																
Universal double cable entry point (KDL-2)			1																
1 x USB connection in mounting frame IP65			3																
2 x USB connection in mounting frame IP65			4																
Fixing adapter																			
VESA 100									1										
VESA closed									2										
Rittal CP-L									4										
Mass storage, internal																			
Hard disk, standard										3									
Hard disk, extended										1									
Option interface MC 1																			
none																		0	
MC-ETH																		1	
MC-CAN2																		9	
MC-MPI																		C	
MC-ISI																		D	
UPS																			
none																		0	
ACU UPS Control Unit																		1	
Runtime visualisation																			
L-force Visu: VisiWinNET Compact XP		(max. 2000 power tags)																1	
L-force Visu: VisiWinNET Standard XP		(min. 250 power tags)																2	
50 power tags																			1
100 power tags																			2
250 power tags																			3
500 power tags																			4
1000 power tags																			5
2000 power tags																			6
4000 power tags																			7
64000 power tags																			8

IPC under Windows® Embedded Standard 2009



Windows® Embedded Standard 2009

Standard equipment

- ▶ Display: analog resistive touchscreen
- ▶ Operating system: Windows® Embedded Standard 2009
- ▶ Processor: Intel Atom 1.6 GHz
- ▶ Main memory: >= 1024 MB

Versions		Order code																	
	38.1 cm (15") TFT display, 1024x768	EP 8 G A S	6	<input type="checkbox"/>	<input type="checkbox"/>	<input type="checkbox"/>	<input type="checkbox"/>	C4	<input type="checkbox"/>	<input type="checkbox"/>	XXX -	0	<input type="checkbox"/>	<input type="checkbox"/>	<input type="checkbox"/>	<input type="checkbox"/>	000	000	
CS5800	Standard (4 F keys)		1																
CS5810	Mounting field, 7 control elements and emergency off		2																
CS5850	Num, Alpha, F keys		5																
CS5870	Num, special, F keys, MF2 German		6																
CS5870	Num, special, F keys, MF2 English		7																
	48.3 cm (19") TFT display, 1280x1024	EP 8 G A S	7	1	<input type="checkbox"/>	<input type="checkbox"/>	<input type="checkbox"/>	C4	<input type="checkbox"/>	<input type="checkbox"/>	XXX -	0	<input type="checkbox"/>	<input type="checkbox"/>	<input type="checkbox"/>	<input type="checkbox"/>	000	000	
CS9800	Standard (4 F keys)		1																
Additional equipment																			
Front design																			
without front-face USB socket			3																
with front-face USB socket			4																
Mounting frame																			
No cable gland			0																
Universal double cable entry point (KDL-2)			1																
1 x USB connection in mounting frame IP65			3																
2 x USB connection in mounting frame IP65			4																
Fixing adapter																			
VESA 100																			1
VESA closed																			2
Rittal CP-L																			3
Mass storage, internal																			
none																			0
Hard disk, standard																			3
Hard disk, extended																			1
Option interface MC 1																			
none																			0
MC-ETH																			1
MC-CAN2 with PCAN Light licence																			B
MC-ISI																			D
UPS																			
none																			0
ACU UPS Control Unit																			1
External memory card																			
none																			0 0
Compact Flash >= 4 GB																			C 6
Compact Flash >= 8 GB																			C 7
Operating system																			
Windows® Embedded Standard 2009																			
on memory card																			5
on hard disk																			6



Control cabinet PC

Technology

The CPC series of industrial PCs (control cabinet PCs) are designed for continuous use under harsh industrial environments. A number of different processor families are used for the various device series:

▶ **CPC 2800**

Modular construction with high-performance low-power processors. Compact design and rugged, fanless construction.

▶ **CPC 5100, CPC 9100 (19")**

Intel® Core™2 Duo processors on ATX mainboards with industrial design characteristics.

We only use chipsets with long-term availability and CPUs from reputable manufacturers.

▶ **Controller 3241 C**

DIN rail PC based on the Intel Atom™ processor with the option to add local I/Os.

Equipment

Depending on the model, CPC industrial PCs feature Ethernet, USB and serial RS232 interfaces as well as various expansion slots.





Options include various drives, memory modules and a UPS (uninterruptible power supply). For the CPC 2800 a maintenance-free capacitor UPS (CAPS) for data backup (remembrance) or for shutting down the system is available as an alternative.

Installation

The CPC industrial PCs have IP20 protection and are designed for installation in a control cabinet or equivalent enclosure. They are fixed in place by means of keyhole slots in the control cabinet mounting plate. The devices include an earthing screw for central equipotential bonding.



Overview

	CPC 2800	Controller 3241 C	CPC 5100	CPC 9100
				
Processor: Atom 1.6 GHz Intel® Core™ Duo 1.66 GHz	● ●	●		
Celeron D 3.2 GHz Intel® Core™2 Duo 1.8 GHz Intel® Core™2 Duo 2.13 GHz			● ● ●	● ● ●
Power supply	24 V DC ± 25 % Option: UPS with external battery or CAPS	24 V DC Option: UPS with external battery	115-230 V AC Option: UPS	115-230 V AC Option: UPS
Drives SD card Compact Flash (type II) Hard disk: standard: 160 GB Hard disk: extended: 80 GB for extended temperature range and continuous operation Removable rack RAID 0/1 CD/DVD R/W (slimline) Installation space for 5¼" drives	Standard 1 x 2.5" Option Option	Standard	1 or 2 x 2.5" Option Option Option Option	1 or 2 x 2.5" Option Option Option Option
Slots	2 x MC slot	1 x MC slot	1 x PCI Express 4x, 5 x PCI	1 x PCI Express 4x, 5 x PCI
Max. slot card length	-		280 mm	Long card
Interfaces	1 x Ethernet 3 x USB 1 x PS2 1 x RS232 1 x DVI-I	2 x Ethernet 100 MBit/s with internal switch 1 x Ethernet 1 GBit/s 3 x USB 1 x DVI-D	2 x Ethernet 8 x USB 2 x PS2 1 x RS232 1 x VGA 1 x DVI	2 x Ethernet 10 x USB 2 x PS2 1 x RS232 1 x VGA 1 x DVI

System features

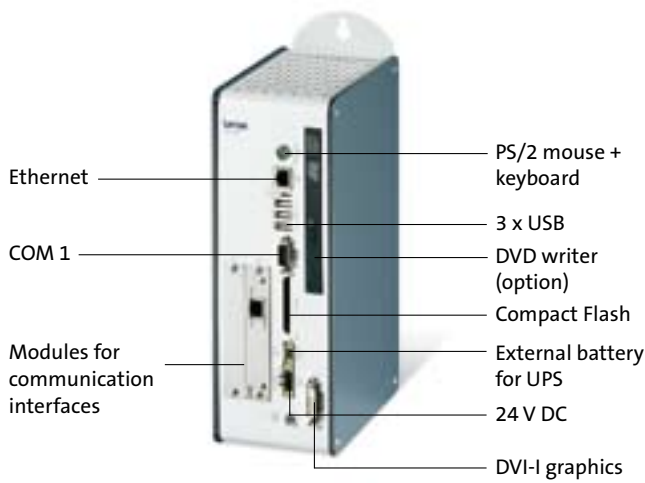

Applications

- ▶ Industrial PC for control and visualisation
- ▶ Automation system for machines in the production process: visualisation, PLC and motion control in a single system
- ▶ Industrial PC for distributed operation and monitoring functions (PC housed in protected environment in control cabinet, local operating unit)

3

Housing/mounting	<ul style="list-style-type: none"> ▶ Metal housing, system labelling on front face ▶ Vertical installation by means of keyhole mounting system
Extendable by means of option cards	<ul style="list-style-type: none"> ▶ MC-ETH Ethernet 100/ 1000 MBit ▶ MC-PBM PROFIBUS Master ▶ MC-CAN2 2-way CAN ▶ MC-MPI MPI/PROFIBUS ▶ MC-ISI serial RS232/RS422/RS485
Interfaces	1 x Ethernet 10/100 MBit, 3 x USB 2.0, 1 x PS/2 mouse + keyboard (combined), 1 x serial interface RS232, 1 x DVI-I video interface
Cooling	<ul style="list-style-type: none"> ▶ Passive via heatsink: Atom 1.6 GHz ▶ Smart Cool: Thermostatically controlled fan with double ball race and function monitoring, MTBF 280,000 h
Operating systems	<ul style="list-style-type: none"> ▶ Microsoft® Windows® CE 6.0 for L-force runtime software ▶ Microsoft® Windows® Embedded Standard 2009 ▶ Microsoft® Windows® XP Multilanguage
Mass storage	<ul style="list-style-type: none"> ▶ Standard: Slot for external Compact Flash memory card ▶ Option: SATA hard disk (standard: >= 160 GB, extended: >= 80 GB for extended temperature range and continuous operation) ▶ Option: DVD writer drive (internal)
Voltage supply	<ul style="list-style-type: none"> ▶ 24 V DC ± 25 % ▶ Option: Integrated UPS module for external battery or (CAPS) capacitor pack (External battery/capacitor packs are accessories and must be ordered separately).
General technical data	<ul style="list-style-type: none"> ▶ Approval: UL 508, CSA C22.2, CE, EN 61000 6-2(4), EN 55022, EN 55024 ▶ Enclosure: IP20 ▶ Temperature range: max. 0 to 50°C operation, -10 to 60°C storage ▶ Relative humidity: 10 to 90%, non-condensing
Dimensions	▶ Housing (H x W x D): 280 x 100 x 180 mm

Control and visualisation under Windows® CE 6.0

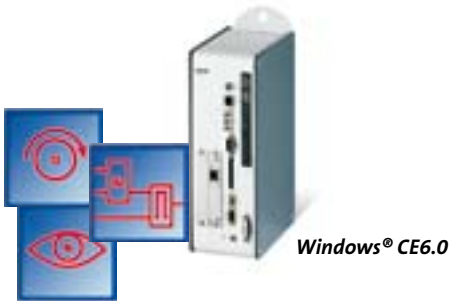

Standard equipment

- ▶ Operating system: Windows® CE 6.0
- ▶ Processor: Intel Atom 1.6 GHz
- ▶ Main memory: >= 1024 MB
- ▶ Memory card: Compact Flash >= 512 MB
- ▶ ACU UPS Control Unit for connecting an external CAPS capacitor pack for data remanence

	Versions	Order code
CPC2800	Control cabinet PC	EP8GAC 1000 0C40 <input type="checkbox"/> <input type="checkbox"/> XX- 0 1 C34 <input type="checkbox"/> <input type="checkbox"/> <input type="checkbox"/> 000
	Option interface MC 1	
	Option interface MC 2	
	none	0 0
	MC-ETH	1 1
	MC-PBM	5 5
	MC-CAN2	9 9
	MC-ISI	D D
	Runtime control technology	
	L-force Logic: LPC 1000	1
	L-force Motion: MPC 1200	2
	Runtime visualisation	
	none	0 0
	L-force Visu: VisiWinNET Compact CE	(max. 2000 power tags) 1
	50 power tags	1
	100 power tags	2
	250 power tags	3
	500 power tags	4
	1000 power tags	5
	2000 power tags	6

Visualisation under Windows® CE 6.0



Standard equipment

- ▶ Operating system: Windows® CE 6.0
- ▶ Processor: Intel Atom 1.6 GHz
- ▶ Main memory: >= 1024 MB
- ▶ Memory card: Compact Flash >= 512 MB

Versions	Order code
CPC2800	Control cabinet PC
	EP8GAC 1000 0C40 <input type="checkbox"/> <input type="checkbox"/> XX - 0 <input type="checkbox"/> C340 1 <input type="checkbox"/> 000
Option interface MC 1	
Option interface MC 2	
none	0 0
MC-ETH	1 1
MC-CAN2	9 9
MC-MPI	C C
MC-ISI	D D
UPS	
none	0
ACU UPS Control Unit	1
Runtime visualisation	
L-force Visu: VisiWinNET Compact CE	(max. 2000 power tags)
50 power tags	1
100 power tags	2
250 power tags	3
500 power tags	4
1000 power tags	5
2000 power tags	6

Visualisation under Windows® XP Multilanguage



Windows® XP Multilanguage

Standard equipment

- ▶ Operating system: Windows® XP Multilanguage

Product	Versions																
CPC2800	Control cabinet PC	EP8GAC	1000	0	<input type="checkbox"/>	<input type="checkbox"/>	<input type="checkbox"/>	<input type="checkbox"/>	<input type="checkbox"/>	XX-	<input type="checkbox"/>	<input type="checkbox"/>	0070	<input type="checkbox"/>	<input type="checkbox"/>	000	
	Processor																
	Intel Atom 1.6 GHz (fanless)			C													
	Intel Core Duo 1.66 GHz (smart cool)			9													
	Main memory																
	>= 1024 MB				4												
	>= 2048 MB ¹⁾				5												
	Mass storage, internal																
	Hard disk, standard					3											
	Hard disk, extended					1											
	Option interface MC 1																
	Option interface MC 2																
	none						0		0								
	MC-ETH						1		1								
	MC-CAN2						9		9								
	MC-MPI						C		C								
	MC-ISI						D		D								
	DVD unit																
	none									0							
	DVD writer drive									1							
	UPS																
	none											0					
	ACU UPS Control Unit											1					
	Runtime visualisation																
	L-force Visu: VisiWinNET Compact XP				(max. 2000 power tags)								1				
	L-force Visu: VisiWinNET Standard XP				(min. 250 power tags)								2				
	50 power tags																1
	100 power tags																2
	250 power tags																3
	500 power tags																4
	1000 power tags																5
	2000 power tags																6
	4000 power tags																7
	64000 power tags																8

¹⁾ Only configurable with Core Duo processor.

IPC under Windows® XP Multilanguage alternative without operating system



Windows® XP Multilanguage

Standard equipment

- ▶ Operating system: Windows® XP Multilanguage

Versions	Order code
CPC2800	Control cabinet PC
	EP8GAC 1000 0 <input type="checkbox"/> <input type="checkbox"/> <input type="checkbox"/> <input type="checkbox"/> <input type="checkbox"/> XX- <input type="checkbox"/> <input type="checkbox"/> 00 <input type="checkbox"/> 000 000
Processor	
Intel Atom 1.6 GHz (fanless)	C
Intel Core Duo 1.66 GHz (smart cool)	9
Main memory	
>= 1024 MB	4
>= 2048 MB ¹⁾	5
Mass storage, internal	
Hard disk, standard	3
Hard disk, extended	1
Option interface MC 1	
Option interface MC 2	
none	0 0
MC-ETH	1 1
MC-CAN2 with PCAN Light licence	B B
MC-ISI	D D
DVD unit	
none	0
DVD writer drive	1
UPS	
none	0
ACU UPS Control Unit	1
Operating system	
none	0
Windows® XP Multilanguage	7

¹⁾ Only configurable with Core Duo processor.



System features

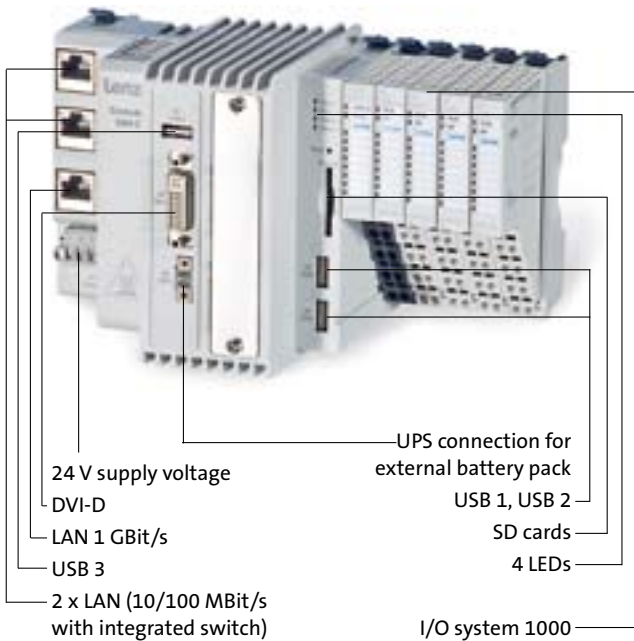

Applications

- ▶ Miniaturised industrial PC for control and visualisation
- ▶ Hardware basis for customised automation systems

3

Housing/mounting	<ul style="list-style-type: none"> ▶ Plastic housing ▶ DIN rail mounting
Extendable by means of option cards	<ul style="list-style-type: none"> ▶ MC-PBM PROFIBUS Master ▶ MC-CAN2 2-way CAN ▶ MC-ISI serial RS232/RS422/RS485
Interface	<ul style="list-style-type: none"> ▶ 2 x 100 MBit/s Ethernet with integrated switch ▶ 1 x Ethernet 1 GBit/s ▶ 3 x USB, e.g. for connecting USB flash drives for data backup ▶ 1 x DVI-D for connecting a monitor panel ▶ Option: I/O system 1000 up to 64 modules, analog and digital inputs and outputs, additional interfaces for peripherals
Cooling	<ul style="list-style-type: none"> ▶ Passive via heatsink
Operating systems	<ul style="list-style-type: none"> ▶ Microsoft® Windows® Embedded Standard 2009
Mass storage	<ul style="list-style-type: none"> ▶ Slot for SD cards (SD card must be ordered separately).
Voltage supply	<ul style="list-style-type: none"> ▶ 24 V DC ± 25 % ▶ Integrated UPS module for external battery pack (The external battery pack is an accessory and must be ordered separately).
General technical data	<ul style="list-style-type: none"> ▶ Approval: to UL 508 in preparation, CE: Meets the requirements of the EU's Low Voltage Directive ▶ Immunity to interference: EN 61000-4-2, EN 61000-4-3, EN 61000-4-4, EN 61000-4-5, EN 61000-4-6 ▶ Vibration resistance: 1G / 15G, according to IEC 60068-2-6 / 60068-2-27 ▶ Enclosure: IP20 ▶ Temperature range: max. 0 to 50°C operation, -25 to 70°C storage
Dimensions	<ul style="list-style-type: none"> ▶ Housing (H x W x D): 112 x 136 x 105 mm

Controller under Windows® Embedded Standard 2009



Windows® Embedded Standard 2009

Standard equipment

- ▶ Operating system: Windows® Embedded Standard 2009
- ▶ Processor: Intel Atom 1.6 GHz
- ▶ Main memory: >= 1 GB RAM
- ▶ Mass storage, internal: >= 4 GB Flash
- ▶ ACU UPS Control Unit for connecting an external battery pack for data remanence

Product	Versions	Order code
3241 C	Control cabinet PC	E 3 2 G A C 1 0 0 0 0 C 4 H <input type="checkbox"/> X X X - 0 1 0 0 5 0 0 0 0 0
	Option interface MC 1	
	none	0
	MC-PBM	5
	MC-CAN2 with PCAN Light licence	B
	MC-ISI	D

Accessories

Product	Versions	Order code
SD card	SD card 1 GB extended quality SD card 2 GB extended quality SD card 4 GB extended quality	EPCZEMSD4 EPCZEMSD5 EPCZEMSD6
Battery pack for ACU UPS	<p>▶ Application: Computer Shutdown for Windows® XP/ Embedded Standard 2009</p> <p>▶ Description: - External battery pack for control cabinet installation Only suitable for use in IPCs with an internal ACU UPS Control Unit. - Connecting cable 2.5 m - Buffer time approx. 3 – 10 min (depending on computer equipment)</p>	EPCZEBVB



System features

Control cabinet PC with ATX mainboard, 1 x PCI Express 4x and 5x PCI slots

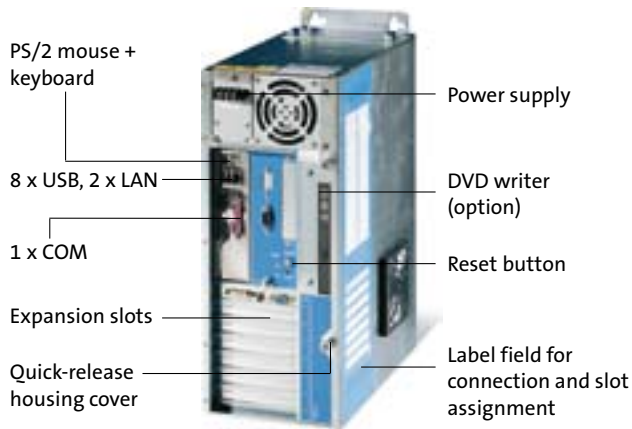

Illustration shows similar system without extension.

Applications

- ▶ Industrial PC for control and visualisation (remote operating unit)
- ▶ Industrial PC for measurement and control tasks, image processing, control computer with slot PLC, etc.
- ▶ Industrial PC for high computing power with extensive interfaces and expansion slots
- ▶ Application server

Housing/mounting	<ul style="list-style-type: none"> ▶ Chromated sheet steel housing with excellent EMC shielding ▶ Vertical installation by means of keyhole mounting system
Chassis components	<ul style="list-style-type: none"> ▶ Fan with speed monitoring for positive pressure ventilation ▶ Card retention clip ▶ All connections and control elements accessible on front face ▶ Status LED for monitoring power, hard disk
Graphics	Max. 256 MB dynamically allocated memory
Expandable by means of PCI	Free slots: 1 x PCI Express 4x, 5 x PCI, max. 280 mm card length
Interfaces	2 x Ethernet 10/100/1000 MBit, 8 x USB 2.0, Audio AC97, PS/2 keyboard & mouse, 1 x serial interface RS232 (COM1), 1 x VGA/DVI
Cooling	Active cooling
Operating systems	Microsoft® Windows® XP Multilanguage
Mass storage	<ul style="list-style-type: none"> ▶ SATA hard disk, standard: >= 160 GB ▶ Option, SATA hard disk, extended: >= 80 GB for extended temperature range and continuous operation ▶ Option: 1 or 2 hard disks, RAID 0/1 functionality can be installed with software ▶ Option: Internal removable rack ▶ Option: DVD writer drive (CD + DVD read/write), SATA
Voltage supply	<ul style="list-style-type: none"> ▶ 115-230 V AC, 50-60 Hz, 350 W ▶ Option: UPS 115/230 V AC, 47-63 Hz, 350 W
General technical data	<ul style="list-style-type: none"> ▶ Approval: CE, EN 61000 6-2(4), EN 55022, EN 55024 ▶ Enclosure: IP20 ▶ Temperature range: max. 0 to 45°C operation, -10 to 60°C storage ▶ Fan for positive pressure ventilation with monitoring ▶ Relative humidity: 10 to 90%, non-condensing
Dimensions	Housing (H x W x D): 408 x 186 x 328 mm

Order data



Control cabinet PC CPC 5100

Version		Order code
CPC 5100	Control cabinet PC, on-board graphics	1170- □ □ □ □ □ □ □ □ □ □
Processors	Mobile Intel® Celeron D 3.2 GHz	5
	Intel® Core™2 Duo 1.8 GHz	7
	Intel® Core™2 Duo 2.13 GHz	8
Main memory	>= 1024 MB	7
	>= 2048 MB	8
	>= 4096 MB	9
Mass storage RAID	without RAID	0
	with RAID 0	1
	with RAID 1	2
Hard disk	Hard disk, standard	1
	Hard disk, standard, x 2	2
	Hard disk, standard, x 2, in removable rack	4
	Hard disk, extended	5
	Hard disk, extended, x 2	6
	Hard disk, extended, x 2, in removable rack	7
Voltage supply	115-230 V AC, 350 W	1
	Integrated UPS 115/230 V AC, 350 W including shutdown software and lead gel rechargeable battery	2
CD/DVD	none	0
	DVD writer drive (CD + DVD read/write), SATA (slimline)	3
Operating system	none	0000
	Windows® XP Multilanguage	4100
Your solution:		1170- □ □ □ □ □ □ □ □ □ □



System features

19" rack PC with ATX mainboard



Applications

- ▶ Industrial PC for control and visualisation (remote operating unit)
- ▶ Industrial PC for measurement and control tasks, image processing, control computer with slot PLC, etc.
- ▶ Industrial PC for high computing power with extensive interfaces and expansion slots
- ▶ Application server

Housing/mounting	▶ 19" / 4 U full-size withdrawable unit, front with carrying handles, sheet steel housing with high EMC resistance
Chassis components	▶ Card retention clip for securing PC plug-in cards ▶ Power button, reset button and 2 x USB connections on front face behind lockable drive cover ▶ Status LED on front face for monitoring power, hard disk
Graphics	Max. 256 MB dynamically allocated memory
Expandable by means of PCI	Free slots: 1 x PCI Express 4x, 5 x PCI, max. 310 mm card length (long card)
Interfaces	2 x Ethernet 10/100/1000 MBit, 8 x USB 2.0 on rear, Audio AC97, PS/2 keyboard & mouse, 1 x serial interface RS232 (COM1), 1 x VGA/DVI, 2 x USB behind drive cover
Cooling	Active cooling
Operating systems	Microsoft® Windows® XP Multilanguage
Mass storage	▶ SATA hard disk, standard: >= 160 GB ▶ Option, SATA hard disk, extended: >= 80 GB for extended temperature range and continuous operation ▶ Option: 1 or 2 hard disks, RAID 0/1 functionality can be installed with software ▶ Option: External removable rack ▶ Option: DVD writer drive (CD + DVD read/write), SATA
Voltage supply	▶ 115-230 V AC, 50-60 Hz, 350 W ▶ Option: UPS 115/230 V AC, 47-63 Hz, 350 W
General technical data	▶ Approval: CE, EN 61000 6-2(4), EN 55022, EN 55024 ▶ Enclosure: IP20 ▶ Temperature range: max. 0 to 45°C operation, -10 to 60°C storage ▶ Fan for positive pressure ventilation with monitoring ▶ Relative humidity: 10 to 90%, non-condensing
Dimensions	▶ (H x W x D): 177 x 483 x 451.4 mm

Order data



Control cabinet PC CPC 9100

Version		Order code
CPC 9100	Control cabinet PC, on-board graphics	1180- □ □ □ □ □ □ □ □ □ □
Processors	Mobile Intel® Celeron D 3.2 GHz Intel® Core™2 Duo 1.8 GHz Intel® Core™2 Duo 2.13 GHz	5 7 8
Main memory	>= 1024 MB >= 2048 MB >= 4096 MB	7 8 9
Mass storage RAID	without RAID with RAID 0 with RAID 1	0 1 2
Hard disk	Hard disk, standard Hard disk, standard, x 2 Hard disk, standard, x 2, in removable rack Hard disk, extended Hard disk, extended, x 2 Hard disk, extended, x 2, in removable rack	1 2 4 5 6 7
Voltage supply	115-230 V AC, 350 W Integrated UPS 115/230 V AC, 350 W *) ¹ including shutdown software and lead gel rechargeable battery	1 2
CD/DVD	none DVD writer drive (CD + DVD read/write), SATA	0 3
Operating system	none Windows® XP Multilanguage	0000 4100
	Your solution:	1180- □ □ □ □ □ □ □ □ □ □

^{*)1} For technical reasons the configuration combinations "1180-□□□423-□□□□"/"1180-□□□723-□□□□" are not possible because the UPS needs one of the three slots.



System features

Industrial PC as thin client terminal, remote operation via network
Multi-operation concept for spatially distributed installations



The thin client terminal can be used to view and operate applications on a remotely located host computer via a network connection. Data is transmitted by means of the Microsoft® RDP (Remote Desktop Protocol).

The host computer can be a Windows® XP system in the case of a single operator location or a Windows® server operating system in the case of multiple operator locations.

All processes are run on the connected server; the thin client is responsible only for the graphics display and the input systems for using the application. In this way the computing power of the client can be kept correspondingly low.

Thin client panels are available as both built-in versions and stand-alone terminals.

3

Design	Built-in version: Embedded line EL 1800-9800	Stand-alone terminal: Command Station CS 5800-9800
Industrial TFT displays	26.4 cm (10.4") to 48.3 cm (19") with resistive touchscreen	38.1 cm (15") to 48.3 cm (19") with resistive touchscreen
Device function	RDP 5.1 Client, connection manager as a user-friendly interface	
Operating systems	Integrated thin client software Windows® CE on Compact Flash module	
Additional system features	For information on the front face design, interfaces, voltage supply and general technical data please refer to the system features for the corresponding device design.	

Thin client connection manager

The user interface of the terminal client is configured by means of the "Terminal Client Manager", which can be used to make all settings. The configuration covers the description of the connection to the appropriate server and the selected programs.

The thin client is preconfigured on delivery. All hardware settings, e.g. display, resolution, depth of colour and touchscreen calibration, are preset.

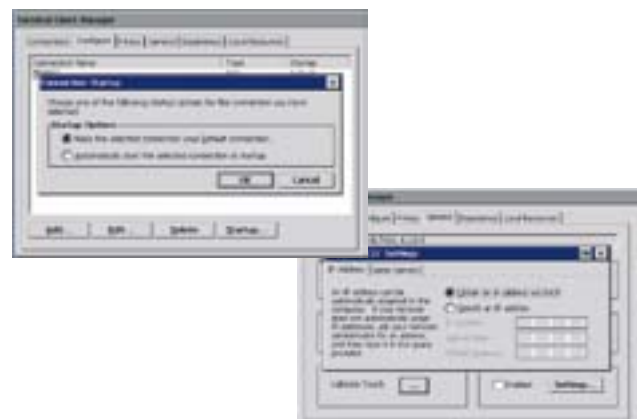

Embedded Line EL 1800 – 9800

IPC as thin client terminal



Standard equipment

- ▶ Display: analog resistive touchscreen
- ▶ Operating system:
Thin client based on Windows® CE 6.0
- ▶ Processor: Intel Atom 1.6 GHz
- ▶ Main memory: >= 1024 MB

Versions		Order code								
EL1800TC	26.4 cm (10.4") TFT display, 640x480 Standard (4 F keys)	EP8GAP	3	<input type="checkbox"/>	00C4000XX - 0000B000 000					
				1						
EL1850TC	Num, Alpha, F keys			<input type="checkbox"/>						
					5					
EL1800STC	26.4 cm (10.4") TFT display, 800x600 Standard (4 F keys)	EP8GAP	4	<input type="checkbox"/>	00C4000XX - 0000B000 000					
				1						
EL1850STC	Num, Alpha, F keys			<input type="checkbox"/>						
					5					
EL2800TC	30.7 cm (12.1") TFT display, 800x600 Standard (4 F keys)	EP8GAP	5	<input type="checkbox"/>	00C4000XX - 0000B000 000					
				1						
EL2850TC	Num, Alpha, F keys			<input type="checkbox"/>						
					5					
EL5800TC	38.1 cm (15") TFT display, 1024x768 Standard (4 F keys)	EP8GAP	6	<input type="checkbox"/>	00C4000XX - 0000B000 000					
				1						
				EL5820TC		F/S keys			<input type="checkbox"/>	
										4
				EL5850TC		Num, Alpha, F keys			<input type="checkbox"/>	
										5
EL5870TC	Num, special, F keys, MF2 German			<input type="checkbox"/>						
					6					
EL5870TC	Num, special, F keys, MF2 English			<input type="checkbox"/>						
					7					
EL9800TC	48.3 cm (19") TFT display, 1280x1024 Standard (4 F keys)	EP8GAP	7	<input type="checkbox"/>	00C4000XX - 0000B000 000					
				1						
				<input type="checkbox"/>						
					1					
Additional equipment										
Front design										
	without front-face USB socket				3					
	with front-face USB socket				4					

Command Station CS 5800 - 9800

IPC as thin client terminal



Standard equipment

- ▶ Display: analog resistive touchscreen
- ▶ Operating system:
Thin client based on Windows® CE 6.0
- ▶ Processor: Intel Atom 1.6 GHz
- ▶ Main memory: >= 1024 MB

Versions		Order code								
CS5800TC	38.1 cm (15") TFT display, 1024x768 Standard (4 F keys)	EP8GAS	6	<input type="checkbox"/>	C400XXX - 0000B000 000					
				1						
				CS5810TC		Mounting field, 7 control elements and emergency off			<input type="checkbox"/>	
										2
				CS5850TC		Num, Alpha, F keys			<input type="checkbox"/>	
										5
				CS5870TC		Num, special, F keys, MF2 German			<input type="checkbox"/>	
					6					
CS5870TC	Num, special, F keys, MF2 English			<input type="checkbox"/>						
					7					
CS9870TC	48.3 cm (19") TFT display, 1280x1024 Standard (4 F keys)	EP8GAP	7	<input type="checkbox"/>	C400XXX - 0000B000 000					
				1						
				<input type="checkbox"/>						
					1					
Additional equipment										
Front design										
	without front-face USB socket				3					
	with front-face USB socket				4					
Mounting frame										
	No cable gland				0					
	Universal double cable entry point (KDL-2)				1					
	1 x USB connection in mounting frame IP65				3					
	2 x USB connection in mounting frame IP65				4					
Fixing adapter										
	VESA 100				1					
	VESA, closed				2					
	Rittal CP-L				3					

System features

Display unit for distributed IPC solutions (operating unit remote from PC)

Built-in version



Stand-alone terminal

Monitor Panel





- ▶ Operator terminal for remotely located industrial PCs as built-in version or stand-alone terminal
- ▶ Touch screen or keyboard operation
- ▶ Digital DVI video interface

3





	Built-in version: Monitor panel DVI MP 1000-9000 DVI	Stand-alone terminal: Command Station DVI CS 5000-9000 DVI
Industrial TFT displays	26.4 cm (10.4") to 48.3 cm (19") with resistive touchscreen	38.1 cm (15") to 48.3 cm (19") with resistive touchscreen
Interfaces	DVI-D video connection (digital only) USB uplink port (connection to PC) Integrated USB hub: 2 x USB downlink port (on rear)	DVI-D video connection (digital only) USB uplink port (connection to PC) Integrated USB hub: 2 x USB downlink port (on rear)
Cable lengths	Standard: 2 m DVI/USB included in scope of supply Optional: 5 m DVI/USB passive, max. 35 m DVI/USB active with DVI/USB extender	Standard: 5 m DVI/USB passive, max. 35 m DVI/USB active with DVI/USB extender
Voltage supply	DC 24 V ± 25 %	DC 24 V ± 25 %
General technical data	<ul style="list-style-type: none"> ▶ Approval: UL 508 (recognised), CSA C22.2 (recognised), CE, EN 61000 6-2(4), EN 55022, EN 55024 ▶ Enclosure: At front IP65, at rear IP20 ▶ Temperature range: 0°C to 50°C operation, -10°C to 60°C storage ▶ Relative humidity: 10 to 90 % non-condensing ▶ Maximum altitude: 3000 m above sea level 	<ul style="list-style-type: none"> ▶ Approval: UL 508 (recognised), CSA C22.2 (recognised), CE, EN 61000 6-2(4), EN 55022, EN 55024 ▶ Enclosure: IP65 ▶ Temperature range: 0°C to 45°C operation, -10°C to 60°C storage ▶ Relative humidity: 10 to 90 % non-condensing ▶ Maximum altitude: 3000 m above sea level

Order data

Monitor panel as built-in version **"Monitor panel DVI"**

Front module		Version		Order code			
	"Touchscreen"	MP 1000 DVI	26.4 cm (10.4") TFT display (640 x 480)	5201-	2	<input type="checkbox"/>	1
		MP 1000s DVI	26.4 cm (10.4") Display (800 x 600)	5202-	2	<input type="checkbox"/>	1
		MP 2000 DVI	30.7 cm (12.1") TFT display (800 x 600)	5203-	2	<input type="checkbox"/>	1
		MP 5000 DVI	38.1 cm (15.0") TFT display (1024 x 768)	5204-	2	<input type="checkbox"/>	1
		MP 9000 DVI	48.3 cm (19.0") TFT display (1280 x 1024)	5205-	2	<input type="checkbox"/>	1
	"Touchscreen plus F/S keys"	MP 5020 DVI	38.1 cm (15.0") TFT display (1024 x 768)	5206-	2	<input type="checkbox"/>	1
	"Touchscreen plus Num, Alpha, F keys"	MP 1050 DVI	26.4 cm (10.4") TFT display (640 x 480)	5207-	2	<input type="checkbox"/>	1
		MP 1050s DVI	26.4 cm (10.4") TFT display (800 x 600)	5208-	2	<input type="checkbox"/>	1
		MP 2050 DVI	30.7 cm (12.1") TFT display (800 x 600)	5209-	2	<input type="checkbox"/>	1
		MP 5050 DVI	38.1 cm (15") TFT display (1024 x 768)	5210-	2	<input type="checkbox"/>	1
	"Touchscreen plus Num, special, F keys and MF2"	MP 5070 DVI	38.1 cm (15") TFT display (1024 x 768) - German layout - English layout	5211-	2	<input type="checkbox"/>	1
				5212-	2	<input type="checkbox"/>	1
Additional equipment		USB socket	No front USB socket Front USB socket (IP65)	0 1			
Order code		Your solution:		□□□□- □ □ □			

Monitor panel as stand-alone terminal **"Command Station DVI"**

Front module		Version		Order code				
	"Touchscreen"	CS 5000 DVI	38.1 cm (15.0") TFT display (1024 x 768)	6300-	2	<input type="checkbox"/>	<input type="checkbox"/>	<input type="checkbox"/>
		CS 9000 DVI	48.3 cm (19.0") TFT display (1280 x 1024)	6301-	2	<input type="checkbox"/>	<input type="checkbox"/>	<input type="checkbox"/>
	"Touchscreen plus, mounting field, 7 control elements and emergency off"	CS 5010 DVI	38.1 cm (15.0") TFT display (1024 x 768)	6302-	2	<input type="checkbox"/>	<input type="checkbox"/>	<input type="checkbox"/>
	"Touchscreen plus Num, Alpha, F keys"	CS 5050 DVI	38.1 cm (15.0") TFT display (1024 x 768)	6303-	2	<input type="checkbox"/>	<input type="checkbox"/>	<input type="checkbox"/>
	"Touchscreen plus Num, special, F keys and MF2"	CS 5070 DVI	38.1 cm (15.0") TFT display (1024 x 768) - German layout - English layout	6304-	2	<input type="checkbox"/>	<input type="checkbox"/>	<input type="checkbox"/>
				6305-	2	<input type="checkbox"/>	<input type="checkbox"/>	<input type="checkbox"/>
Additional equipment		USB socket	No front USB socket Front USB socket (IP65)	0 1				
		Mounting frame (at bottom)	No cable gland Universal double cable entry point (KDL-2) *) ¹ USB connection in mounting frame IP65	0 1 3				
		Fixing adapter	VESA 100 VESA closed Rittal CP-L	0 1 2				
Order code		Your solution:		□□□□- □ □ □				

*)¹ Scope of supply includes 1 blind grommet

DVI/USB extender

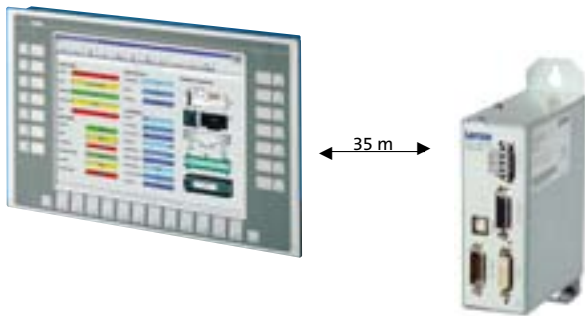

Components

The system consists of a transmitter module, which is mounted close to the PC, and a receiver module, which is mounted directly on the rear face of the monitor panel.

▶ Transmitter module TX:

Mounted in control cabinet via keyhole mounting system
 Dimensions: 52 x 140 x 101.5 mm (W x H x D)
 Mounting area: 52 x 190 mm (W x H)
 Voltage supply: 24 V DC
 Connecting cable to PC supplied 2 m (max. 5 m)

▶ Receiver module RX:

Dimensions: 27.5 x 172.5 x 100 mm (W x H x D)
 Voltage supply: via transmitter module
 Supply: 24 V for monitor
 Connecting cable: 0.4 m

Transmission

The DVI/USB extender can be used to extend the distance between the control cabinet PC and the operator panel to a maximum of 35 m for remote operating concepts. All signals - digital real-time image information, USB peripherals, mouse and keyboard - are transmitted via a TwinLAN cable (2 x CAT-7). The voltage supply for the panel (24 V DC) is also supplied via this cable connection.

- ▶ Transmission of DVI and USB (1.1) signals
- ▶ Transmission distance: max. 35 m plus max. 5 m from PC to TX module
- ▶ Transmission of supply voltage
- ▶ Simple installation: plug and play, software driver not needed
- ▶ Simple mounting: TX module on mounting plate, RX module is secured to rear of monitor panel.



Order data

	Description	Version	Order code	
	DVI/USB extender	Transmitter and receiver unit	EPCZEBED	
	Transmission cable	TwinLAN 10 m		EYC0045A0100R05T05
		TwinLAN 15 m		EYC0045A0100R05T05
		TwinLAN 20 m		EYC0045A0100R05T05
		TwinLAN 25 m		EYC0045A0100R05T05
		TwinLAN 30 m		EYC0045A0100R05T05
		TwinLAN 35 m		EYC0045A0100R05T05
		DVI + USB cable 5 m		EYC0000A0350X00008

Accessories

	Description	Version	Order code
	Compact Flash	Compact Flash Card 512 MB Compact Flash Card 4 GB Compact Flash Card 8 GB	EPCZEMCF3 EPCZEMCF6 EPCZEMCF7
	USB Memory Stick	1 GB 4 GB	EPCZEMUS4 EPCZEMUS6
	Touchpen	with spiral wrap	EPCZEBTP
	Power supply unit	Power supply unit 100-240AC/24DC/10	EZV2400-000
	Battery pack for ACU UPS	<ul style="list-style-type: none"> ▶ Application: Computer Shutdown for Windows® XP/Embedded Standard 2009 ▶ Description: <ul style="list-style-type: none"> - External battery pack for control cabinet installation - Only suitable for use in IPCs with an internal ACU UPS Control Unit. - Connecting cable 2.5 m - Buffer time approx. 3 – 10 min (depending on computer equipment) 	EPCZEBVB
	Capacitor pack (CAPS) for ACU UPS	<ul style="list-style-type: none"> ▶ Application: Data remanence for industrial PCs with Windows® CE ▶ Description: <ul style="list-style-type: none"> - CAPS capacitor pack for control cabinet installation - Only suitable for use in IPCs with an internal ACU UPS Control Unit. - Connecting cable 2.5 m - Buffer time approx. 5 - 20 s 	EPCZEBVC
	Extension cable for ACU UPS	10 m, e.g. for Command Station	EYC0042V0100R01T01
	CAN bus plug	"Node" CAN bus plug - Sub-D, 90° - Screw terminals	EPM-T950
		"Termination" CAN bus plug - Sub-D, 90° - Screw terminals - Integrated terminating resistor	EPM-T951
		"Straight" CAN bus plug - Sub-D, 180° - Screw terminals - Switchable terminating resistor	EPM-T952
		"Switch" CAN bus plug - Sub-D, 90° - Tension spring terminal - Switchable terminating resistor	EWZ0046

Accessories for Command Station

	Description	Version	Order code
	Cable entry	Accessories for KDL-2: The "KDL-2" equipment option, a universal double cable entry point, includes one blind grommet as standard. The second grommet, which is available for various cable diameters, must be ordered separately.	
		Blind grommet	EPCZMCB
		Cable grommet 3.0 to 4.0 mm	EPCZMCD
		Cable grommet 4.0 to 5.0 mm	EPCZMCV
		Cable grommet 5.0 to 6.0 mm	EPCZMCF
		Cable grommet 6.0 to 7.0 mm	EPCZMCS
		Cable grommet 7.0 to 8.0 mm	EPCZMCG
	Support arm adapter	CP-L connection console (Rittal # CP6508.010)	EPCZMB2
		Swivel housing bracket (Rittal # IW6902.670)	EPCZMB4





I/O systems

I/O systems for optimum performance

I/O system 1000

Introduction	4-2
Standards and fields of application	4-4
Bus coupler	4-5
Digital I/O	4-7
Analog I/O	4-14
Temperature measurement	4-17
Counter	4-18
Encoder evaluation	4-19
Technology modules	4-20
Power supply modules	4-21
Power distributor modules	4-22
Accessories	4-23

I/O system 1000

Fulfils the strictest of requirements

The availability of Ethernet-based bus systems is forming the basis for new automation concepts in mechanical and systems engineering - the power limits of established bus systems that were available until now have been surpassed.

The L-force I/O system 1000 represents a highly deterministic method of controlling input and output modules and even encompasses the ability to read in the kinds of touch probe inputs that are required for synchronised movements within the context of clocked production processes. The minimal internal cycle time combined with the use of a time stamp ensures that the I/O system 1000 can meet even the toughest requirements in terms of speed. As such, it is also suitable for use within real-time-based architectures.

At the very first glance, the system impresses with its slimline design and clearly structured diagnostics and labelling concepts. The I/O modules, which offer space for 8 connection points, are provided with a space of 12.5 mm on conventional DIN rails.

User-oriented connection system

The "inner life" of the I/O system is also user-friendly down to the finest detail: the I/O compound module, which has a modular structure, consisting of a terminal block with rear panel bus connection, as well as electronics designed to protect against polarity reversal. This enables defective electronic modules to be replaced if maintenance work is required, without loosening the wiring from the base module. As those with plenty of practical experience will know, this eliminates a frequent error cause - incorrect wiring. Also of considerable benefit is the staircase shape of the connection level including tension spring technology and permanent wiring, which has proven highly effective for standard terminals over the years. All that is needed for the wiring itself is a simple screwdriver. The labelling and wiring of the new system is just as simple as combining the modules with complete stations. Up to 64 modules can be assembled via the integrated backplane bus through simple insertion, without any wiring requirements.

Permanent wiring

- ▶ 2-part concept: base module and electronic module
- ▶ In the event of maintenance work, the electronics can be replaced without contact with the wiring
- ▶ Item designation remains on the base module
- ▶ Codes protect against the assignment of an incorrect module type

➤ **Wiring faults in the event of service are completely eliminated**

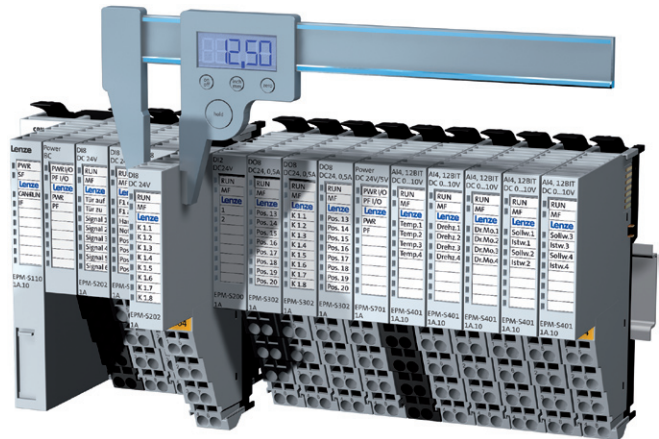

Compact design

- ▶ Slimline design
- ▶ 8 connection points at a width of just 12.5 mm
- ▶ Tried and tested tension spring technology
- ▶ Wiring level generated in a ladder shaped space-saving manner
- ▶ Consistent separation of electronic and wiring levels
- ▶ Up to 64 modules can be mounted
- ▶ Automatic connection via the backplane bus

Performance and robustness

- ▶ Gilded contacts ensure safe connection between the modules
- ▶ Fault-tolerant protocols ensure maximum availability – even in the case of individual frame errors
- ▶ The high bandwidth of 48 Mbps allows for extremely fast response times without telegram overheads





Fast diagnostics

- ▶ Clear labelling concept and diagnostic concept
- ▶ Brightly lit LEDs can be easily identified even in a poorly lit control cabinet
- ▶ An LED and inscription field are clearly assigned to each channel

➤ **Optimum combination of readability and labelling in the smallest of spaces**



Integrated shield support

- ▶ Holders for shield buses are available as accessories
- ▶ Direct installation of standard 10 x 3 bus bars on the I/O station
- ▶ Shield support with standard cable fastenings and shield clamps possible

➤ **Fully integrated shield concept, and yet no special terminals necessary**

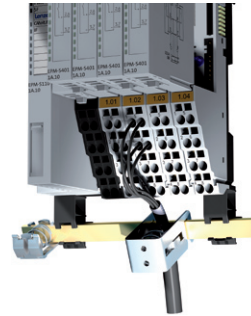

Scalable supply concept

- ▶ The main supply is a fixed component of the bus coupler and supplies both electronics and the I/O level
- ▶ Optional additional I/O supply, in the event that more than 10 A output current is required
- ▶ Optional additional I/O supply and electronic supply for extremely large station structures
- ▶ Each new I/O supply forms a separate potential area



Simple connection

- ▶ Circuit diagram and connection plan printed on the module itself
- ▶ To the sides: detailed view
- ▶ On the front: brief view, can also be seen when the modules are fitted

➤ **The manual is thus virtually redundant!**



Tool-free mounting

- ▶ Direct snap-in mounting on the DIN rail
- ▶ Individual module or entire station can be mounted
- ▶ Complete blocks can subsequently be added to the DIN rail
- ▶ Unlocking levers remain open such that complete stations can be fitted and removed

➤ **Simply slide in and lock – no need for any tools**

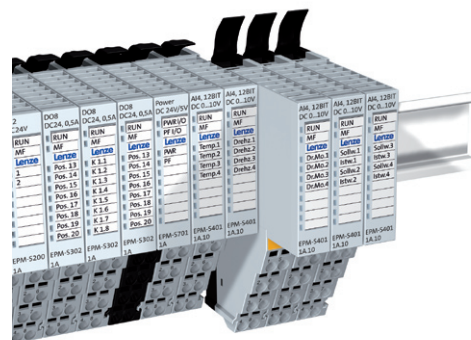





Standards and fields of application

Area	Values															
Vibration resistance	1G / 15G, as per IEC 60068-2-6 / 60068-2-27															
Climatic conditions	RH1 as per EN 61131-2 (non-condensing, relative humidity 10 ... 95 %)															
Admissible temperature ranges	Transport: -25 ... +70°C Storage: -25 ... +70°C Operation: ▶ Horizontal installation 0 ... +60°C ▶ Vertical installation 0 ... +60°C															
Mounting positions	Horizontal and vertical															
Degree of pollution	Degree of pollution 2 in accordance with EN 61131-2															
Noise emission	Compliance with limit class A in accordance with EN 61000-6-4															
Noise immunity	<table border="1"> <thead> <tr> <th>Requirements</th> <th>Standard</th> <th>Severity</th> </tr> </thead> <tbody> <tr> <td>ESD</td> <td>EN 61000-4-2</td> <td>Severity 3, 8 kV in the case of air discharge, 4 kV in the case of contact discharge</td> </tr> <tr> <td>Conducted radio frequency</td> <td>EN 61000-4-6</td> <td>150 kHz ... 80 MHz, 10V/m 80 % AM (1 kHz)</td> </tr> <tr> <td>RF interference (housing)</td> <td>EN 61000-4-3</td> <td>80 ... 1000 MHz, 10 V/m 80 % AM (1 kHz)</td> </tr> <tr> <td>Burst</td> <td>EN 61000-4-4</td> <td>Severity 3</td> </tr> </tbody> </table>	Requirements	Standard	Severity	ESD	EN 61000-4-2	Severity 3, 8 kV in the case of air discharge, 4 kV in the case of contact discharge	Conducted radio frequency	EN 61000-4-6	150 kHz ... 80 MHz, 10V/m 80 % AM (1 kHz)	RF interference (housing)	EN 61000-4-3	80 ... 1000 MHz, 10 V/m 80 % AM (1 kHz)	Burst	EN 61000-4-4	Severity 3
Requirements	Standard	Severity														
ESD	EN 61000-4-2	Severity 3, 8 kV in the case of air discharge, 4 kV in the case of contact discharge														
Conducted radio frequency	EN 61000-4-6	150 kHz ... 80 MHz, 10V/m 80 % AM (1 kHz)														
RF interference (housing)	EN 61000-4-3	80 ... 1000 MHz, 10 V/m 80 % AM (1 kHz)														
Burst	EN 61000-4-4	Severity 3														
Insulation resistance	In accordance with IEC 61131-2															
Insulation voltage against reference earth	500 V															
Electrical isolation to system bus (CAN)	Galvanically decoupled															
Electrical isolation to process level	Galvanically decoupled															
Terminals	Tension spring 1.5 mm ² (AWG15)															
Enclosure	IP20															
Labelling	CE: Meets the requirements of the EU's Low Voltage Directive cULus: Approvals according to UL 508															





Bus coupler

Rated data

			
Version	CANopen	PROFIBUS	EtherCAT
Order designation	EPM-S110	EPM-S120	EPM-S130
Function	CANopen bus coupler with integrated power supply module	PROFIBUS bus coupler with integrated power supply module	EtherCAT bus coupler with integrated power supply module
Current supply			
Electronics supply voltage	24 V DC (20.4 ... 28.8 V)	24 V DC (20.4 ... 28.8 V)	24 V DC (20.4 ... 28.8 V)
Current consumption max.	0.95 A	0.9 A	0.95 A
Backplane bus current output	3 A	3 A	3 A
Fusing	via power supply module	via power supply module	via power supply module
I/O supply output voltage	24 V	24 V	24 V
I/O supply output current	10 A	10 A	10 A
Electrical isolation	500 V between I/O supply, electronic supply and fieldbus	500 V between I/O supply, electronic supply and fieldbus	500 V between I/O supply, electronic supply and fieldbus
Communication			
Bus system	CANopen (DS 301)	PROFIBUS (DP-V0/V1)	EtherCAT (CoE)
Bus devices	Slave	Slave	Slave
Baud rate	10 kbps to 1 Mbps	9.6 kbps to 12 Mbps	100 Mbps
Connections	9-pole Sub-D	9-pole Sub-D	RJ45, double
Process data	16 Rx / 16 Tx	244 bytes	4 kbyte
Max. number of devices for fieldbus	127	125 (without repeater max. 32)	65535
Device description file	EDS	GSE	XML (Modular Device Profile MDP)
Status display			
Voltage supply	Supply ok / fuse defective	Supply ok / fuse defective	Supply ok / fuse defective
Bus diagnostics	-RUN-LED in acc. with CANopen -ready for operation -system error	-ready for operation -system error	-ready for operation -system error
General			
Number of I/O modules	max. 64	max. 64	max. 64
Scope of supply	Bus coupler module incl. power supply module	Bus coupler module incl. power supply module	Bus coupler module incl. power supply module
Packaging unit	1	1	1
Enclosure	IP20	IP20	IP20
Dimensions (height x width x depth)	100 x 48 x 76	100 x 48 x 76	100 x 48 x 76
Weight	0.16 kg	0.16 kg	0.16 kg

Bus coupler

Rated data

			
Version	PROFINET	DeviceNet	Modbus TCP/IP
Order designation	EPM-S140	EPM-S150	EPM-S160
Function	PROFINET bus coupler with integrated power supply module	DeviceNet bus coupler with integrated power supply module	Modbus TCP/IP bus coupler with integrated power supply module
Current supply			
Electronics supply voltage	24 V DC (20.4 ... 28.8 V)	24 V DC (20.4 ... 28.8 V)	24 V DC (20.4 ... 28.8 V)
Current consumption max.	0.95 A	0.95 A	0.95 A
Backplane bus current output	3 A	3 A	3 A
Fusing	via power supply module	via power supply module	via power supply module
I/O supply output voltage	24 V	24 V	24 V
I/O supply output current	10 A	10 A	10 A
Electrical isolation	500 V between I/O supply, electronic supply and fieldbus	500 V between I/O supply, electronic supply and fieldbus	500 V between I/O supply, electronic supply and fieldbus
Communication			
Bus system	PROFINET (RT/IRT)	DeviceNet	Modbus TCP/IP
Bus devices	Device	Slave	Slave
Baud rate	100 Mbps	500 kbps	100 Mbps
Connections	RJ45, double	5-pole pluggable terminal	RJ45
Process data	512 bytes	256 bytes	1 kbyte
Max. number of devices for fieldbus	255	64	-
Device description file	GSDML	EDS	-
Status display			
Voltage supply	Supply ok / fuse defective	Supply ok / fuse defective	Supply ok / fuse defective
Bus diagnostics	-ready for operation -system error	-ready for operation -system error	-ready for operation -system error
General			
Number of I/O modules	max. 64	max. 64	max. 64
Scope of supply	Bus coupler module incl. power supply module	Bus coupler module incl. power supply module	Bus coupler module incl. power supply module
Packaging unit	1	1	1
Enclosure	IP20	IP20	IP20
Dimensions (height x width x depth)	100 x 48 x 76	100 x 48 x 76	100 x 48 x 76
Weight	0.16 kg	0.16 kg	0.16 kg



Digital I/O

Inputs, positive switching Rated data



Version	DI 2, 24 V DC	DI 4, 24 V DC	DI 8, 24 V DC
Order designation	EPM-S200	EPM-S201	EPM-S202
Function	2 digital inputs	4 digital inputs	8 digital inputs
Current supply			
Backplane bus current consumption	55 mA	55 mA	60 mA
Electrical isolation	500 V between backplane bus and I/O signal	500 V between backplane bus and I/O signal	500 V between backplane bus and I/O signal
Signal			
Number of inputs/outputs	2/-	4/-	8/-
Rated voltage	24 V DC	24 V DC	24 V DC
Input level	Type 1 in acc. with IEC 61131-2 "0": 0 ... 5 V "1": 15 ... 28.8 V	Type 1 in acc. with IEC 61131-2 "0": 0 ... 5 V "1": 15 ... 28.8 V	Type 1 in acc. with IEC 61131-2 "0": 0 ... 5 V "1": 15 ... 28.8 V
Filter	3 ms	3 ms	3 ms
Connection system	1-/2-/3-wire conductor technology	1-/2-wire conductor technology	1-wire conductor technology
I/O wiring	PNP	PNP	PNP
Communication			
Width in the input process image	8 bits / 2 bits (EPM-S110)	8 bits / 4 bits (EPM-S110)	8 bits
Status display			
Module status	Ready for operation / error	Ready for operation / error	Ready for operation / error
Signal status	1 LED per channel	1 LED per channel	1 LED per channel
General			
Scope of supply	I/O compound module (base module + electronic module)	I/O compound module (base module + electronic module)	I/O compound module (base module + electronic module)
Packaging unit	1	1	1
Enclosure	IP20	IP20	IP20
Dimensions (height x width x depth)	100 x 12.5 x 76	100 x 12.5 x 76	100 x 12.5 x 76
Weight	0.06 kg	0.06 kg	0.06 kg
Wiring diagram			

Digital I/O

Inputs, positive switching Rated data



Version	DI 4, 24 V DC	DI 2, 2μs, 24 V DC
Order designation	EPM-S203	EPM-S207
Function	4 digital inputs, three-wire conductor connection system	2 high-speed digital inputs with time stamp
Current supply		
Backplane bus current consumption	55 mA	85 mA
Electrical isolation	500 V between backplane bus and I/O signal	500 V between backplane bus and I/O signal
Signal		
Number of inputs/outputs	4/-	2/-
Rated voltage	24 V DC	24 V DC
Input level	Type 1 according to IEC 61131-2 "0": 0 ... 5 V "1": 15 ... 28.8 V	Type 1 according to IEC 61131-2 "0": 0 ... 5 V "1": 15 ... 28.8 V
Filter	3 ms	2 μs - 3 ms
Time stamp		yes
Connection system	1-/2-/3-wire conductor technology	1-/2-/3-wire conductor technology
I/O wiring	PNP	PNP
Communication		
Width in the input process image	8 bits / 4 bits (EPM-S110)	4-60 bytes
Parameter data (PROFIBUS/PROFINET)		6 bytes
Status display		
Module status	Ready for operation / error	Ready for operation / error
Signal status	1 LED per channel	1 LED per channel
General		
Scope of supply	I/O compound module (base module + electronic module)	I/O compound module (base module + electronic module)
Packaging unit	1	1
Enclosure	IP20	IP20
Dimensions (height x width x depth)	100 x 12.5 x 76	100 x 12.5 x 76
Weight	0.06 kg	0.06 kg

Wiring diagram

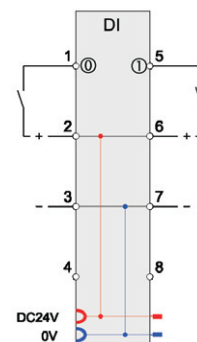
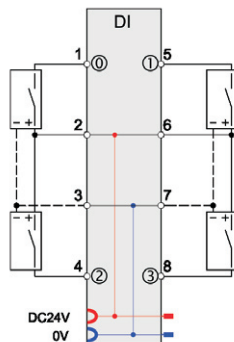



Digital I/O

Inputs, negative switching

Rated data



Version	DI 2, NPN, 24 V DC	DI 4, NPN, 24 V DC	DI 8, NPN, 24 V DC
Order designation	EPM-S204	EPM-S205	EPM-S206
Function	2 digital inputs, negative switching	4 digital inputs, negative switching	8 digital inputs, negative switching
Current supply			
Backplane bus current consumption	60 mA	60 mA	65 mA
Electrical isolation	500 V between backplane bus and I/O signal	500 V between backplane bus and I/O signal	500 V between backplane bus and I/O signal
Signal			
Number of inputs/outputs	2/-	4/-	8/-
Rated voltage	24 V DC	24 V DC	24 V DC
Input level	Type 1 in acc. with IEC 61131-2 "0": 15 ... 28.8 V "1": 0 ... 5 V	Type 1 in acc. with IEC 61131-2 "0": 15 ... 28.8 V "1": 0 ... 5 V	Type 1 in acc. with IEC 61131-2 "0": 15 ... 28.8 V "1": 0 ... 5 V
Filter	3 ms	3 ms	3 ms
Connection system	1-/2-/3-wire conductor technology	1-/2-wire conductor technology	1-wire conductor technology
I/O wiring	NPN	NPN	NPN
Communication			
Width in the input process image	8 bits / 2 bits (EPM-S110)	8 bits / 4 bits (EPM-S110)	8 bits
Status display			
Module status	Ready for operation / error	Ready for operation / error	Ready for operation / error
Signal status	1 LED per channel	1 LED per channel	1 LED per channel
General			
Scope of supply	I/O compound module (base module + electronic module)	I/O compound module (base module + electronic module)	I/O compound module (base module + electronic module)
Packaging unit	1	1	1
Enclosure	IP20	IP20	IP20
Dimensions (height x width x depth)	100 x 12.5 x 76	100 x 12.5 x 76	100 x 12.5 x 76
Weight	0.06 kg	0.06 kg	0.06 kg

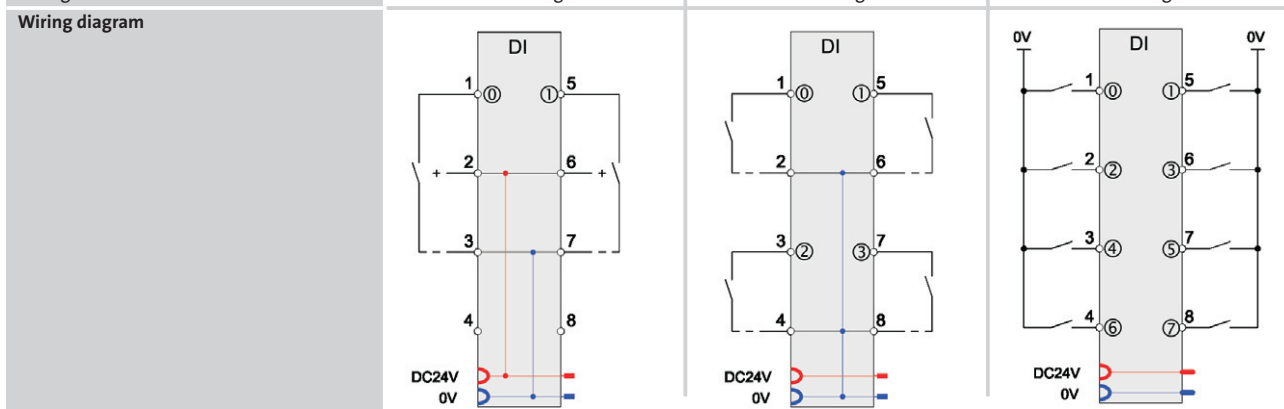

Digital I/O

Outputs, positive switching

Rated data



Version	DO 2, 24 V DC, 0.5 A	DO 4, 24 V DC, 0.5 A	DO 8, 24 V DC, 0.5 A
Order designation	EPM-S300	EPM-S301	EPM-S302
Function	2 digital outputs	4 digital outputs	8 digital outputs
Current supply			
Backplane bus current consumption	55 mA	55 mA	65 mA
I/O supply current consumption	5 mA + load	10 mA + load	15 mA + load
Electrical isolation	500 V between backplane bus and I/O signal	500 V between backplane bus and I/O signal	500 V between backplane bus and I/O signal
Signal			
Number of inputs/outputs	-/2	-/4	-/8
Rated voltage	24 V DC	24 V DC	24 V DC
Output current per channel	0.5 A	0.5 A	0.5 A
Output delay	30 μs - 175 μs	30 μs - 175 μs	30 μs - 175 μs
Short-circuit strength	Yes, electronic	Yes, electronic	Yes, electronic
Switching frequency at ohmic load	1 kHz	1 kHz	1 kHz
Switching frequency at inductive load	0.5 Hz	0.5 Hz	0.5 Hz
Switching frequency at lamp load	10 Hz	10 Hz	10 Hz
Contact			
Connection system	1-/2-/3-wire conductor technology	1-/2-wire conductor technology	1-wire conductor technology
I/O wiring	PNP	PNP	PNP
Communication			
Width in the output process image	8 bits / 2 bits (EPM-S110)	8 bits / 4 bits (EPM-S110)	8 bits
Status display			
Module status	Ready for operation/error/overload	Ready for operation/error/overload	Ready for operation/error/overload
Signal status	1 LED per channel	1 LED per channel	1 LED per channel
General			
Scope of supply	I/O compound module (base module + electronic module)	I/O compound module (base module + electronic module)	I/O compound module (base module + electronic module)
Packaging unit	1	1	1
Enclosure	IP20	IP20	IP20
Dimensions (height x width x depth)	100 x 12.5 x 76	100 x 12.5 x 76	100 x 12.5 x 76
Weight	0.06 kg	0.06 kg	0.06 kg
Wiring diagram			



Digital I/O

Outputs, positive switching

Rated data



Version	DO 2, 24 V DC, 2 A	DO 4, 24 V DC, 2 A	DO2, 24 V DC, 1 μ s
Order designation	EPM-S306	EPM-S309	EPM-S310
Function	2 digital outputs, 2 A	4 digital outputs, 2 A	2 high-speed digital outputs with time stamp
Current supply			
Backplane bus current consumption	55 mA	55 mA	85 mA
I/O supply current consumption	5 mA	10 mA	14 mA
Electrical isolation	500 V between backplane bus and I/O signal	500 V between backplane bus and I/O signal	500 V between backplane bus and I/O signal
Signal			
Number of inputs/outputs	-/2	-/4	-/2
Rated voltage	24 V DC	24 V DC	24 V DC
Output current per channel	2 A	2 A (total current max. 4 A)	0.5 A
Output delay	30 μ s - 175 μ s	30 μ s - 175 μ s	1 μ s
Short-circuit strength	Yes, electronic	Yes, electronic	Yes, electronic
Switching frequency at ohmic load	1 kHz	1 kHz	15 kHz
Switching frequency at inductive load	0.5 Hz	0.5 Hz	15 kHz
Switching frequency at lamp load	10 Hz	10 Hz	15 kHz
Contact			
Connection system	1-/2-/3-wire conductor technology	1-/2-wire conductor technology	1-/2-wire conductor technology
I/O wiring	PNP	PNP	PNP
Communication			
Width in the input process image			4 bytes
Width in the output process image	8 bits / 2 bits (EPM-S110)	8 bits / 4 bits (EPM-S110)	4-60 bytes
Parameter data (PROFIBUS/PROFINET)			2 bytes
Status display			
Module status	Ready for operation/error/overload	Ready for operation/error/overload	Ready for operation/error/overload
Signal status	1 LED per channel	1 LED per channel	1 LED per channel
General			
Scope of supply	I/O compound module (base module + electronic module)	I/O compound module (base module + electronic module)	I/O compound module (base module + electronic module)
Packaging unit	1	1	1
Enclosure	IP20	IP20	IP20
Dimensions (height x width x depth)	100 x 12.5 x 76	100 x 12.5 x 76	100 x 12.5 x 76
Weight	0.06 kg	0.06 kg	0.06 kg
Wiring diagram			

Digital I/O

Outputs, negative switching

Rated data



Version	DO 2, NPN, 24 V DC, 0.5 A	DO 4, NPN, 24 V DC, 0.5 A	DO 8, NPN, 24 V DC, 0.5 A
Order designation	EPM-S303	EPM-S304	EPM-S305
Function	2 digital outputs negative switching	4 digital outputs negative switching	8 digital outputs negative switching
Current supply			
Backplane bus current consumption	60 mA	65 mA	70 mA
I/O supply current consumption	3 mA + load	5 mA + load	10 mA + load
Electrical isolation	500 V between backplane bus and I/O signal	500 V between backplane bus and I/O signal	500 V between backplane bus and I/O signal
Signal			
Number of inputs/outputs	-/2	-/4	-/8
Rated voltage	24 V DC	24 V DC	24 V DC
Output current per channel	0.5 A	0.5 A	0.5 A
Output delay	30 μs - 175 μs	30 μs - 175 μs	30 μs - 175 μs
Short-circuit strength	Yes, electronic	Yes, electronic	Yes, electronic
Switching frequency at ohmic load	1 kHz	1 kHz	1 kHz
Switching frequency at inductive load	0.5 Hz	0.5 Hz	0.5 Hz
Switching frequency at lamp load	10 Hz	10 Hz	10 Hz
Contact			
Connection system	1-/2-/3-wire conductor technology	1-/2-wire conductor technology	1-wire conductor technology
I/O wiring	NPN	NPN	NPN
Communication			
Width in the output process image	8 bits / 2 bits (EPM-S110)	8 bits / 4 bits (EPM-S110)	8 bits
Status display			
Module status	Ready for operation/error/overload	Ready for operation/error/overload	Ready for operation/error/overload
Signal status	1 LED per channel	1 LED per channel	1 LED per channel
General			
Scope of supply	I/O compound module (base module + electronic module)	I/O compound module (base module + electronic module)	I/O compound module (base module + electronic module)
Packaging unit	1	1	1
Enclosure	IP20	IP20	IP20
Dimensions (height x width x depth)	100 x 12.5 x 76	100 x 12.5 x 76	100 x 12.5 x 76
Weight	0.06 kg	0.06 kg	0.06 kg
Wiring diagram			



Digital I/O

Relay

Rated data



Relay 2, 230 V AC, 3 A

Version	EPM-S308
Order designation	EPM-S308
Function	2 relay outputs, 230 V
Current supply	
Backplane bus current consumption	55 mA
Signal	
Number of inputs/outputs	-/2
Rated voltage	30 V DC / 230 V AC
Output current per channel	3 A / 3 A
Switching frequency at ohmic load	100 Hz
Contact	NO contact
Communication	
Width in the output process image	8 bits / 2 bits (EPM-S110)
Status display	
Module status	Ready for operation / error
Signal status	1 LED per channel
General	
Scope of supply	I/O compound module (base module + electronic module)
Packaging unit	1
Enclosure	IP20
Dimensions (height x width x depth)	100 x 12.5 x 76
Weight	0.06 kg

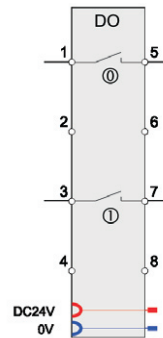
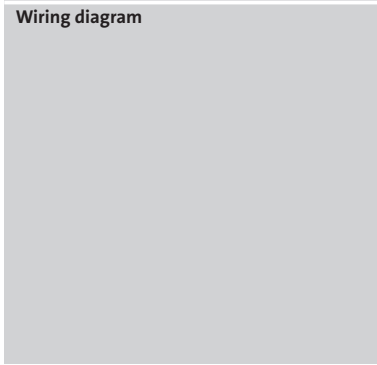

Analog I/O

Inputs

Rated data



Version	AI 2, 12 bits, 0 ... 10 V	AI 4, 12 bits, 0 ... 10 V	AI 2, 12 bits, 0/4 ... 20 mA
Order designation	EPM-S400	EPM-S401	EPM-S402
Function	2 analog inputs, voltage measurement	4 analog inputs, voltage measurement	2 analog inputs, current measurement
Current supply			
Backplane bus current consumption	70 mA	70 mA	70 mA
I/O supply current consumption	15 mA	15 mA	15 mA
Electrical isolation	500 V between backplane bus and I/O signal	500 V between backplane bus and I/O signal	500 V between backplane bus and I/O signal
Signal			
Number of inputs/outputs	2/-	4/-	2/-
Signal	0 ... 10 V DC	0 ... 10 V DC	0/4 ... 20mA
Filter	1 kHz	1 kHz	1 kHz
Sensor			
Resolution	12 bits	12 bits	12 bits
Usage error margin	+/- 0.3 %	+/- 0.3 %	+/-0.3 % at 0 ... 20 mA, +/-0.5 % at 4 ... 20 mA
Basic error margin (at 25 °C)	+/- 0.2 %	+/- 0.2 %	+/-0.2 % at 0 ... 20 mA, +/-0.3 % at 4 ... 20 mA
A/D conversion time	4 ms (all channels)	8 ms (all channels)	4 ms (all channels)
Communication			
Width in the input process image	4 bytes	8 bytes	4 bytes
Parameter data (PROFIBUS/PROFINET)	6 bytes	8 bytes	6 bytes
Status display			
Module status	Ready for operation / error	Ready for operation / error	Ready for operation / error
Signal status	1 LED per channel	1 LED per channel	1 LED per channel
General			
Scope of supply	I/O compound module (base module + electronic module)	I/O compound module (base module + electronic module)	I/O compound module (base module + electronic module)
Packaging unit	1	1	1
Enclosure	IP20	IP20	IP20
Dimensions (height x width x depth)	100 x 12.5 x 76	100 x 12.5 x 76	100 x 12.5 x 76
Weight	0.06 kg	0.06 kg	0.06 kg
Wiring diagram			



Analog I/O

Inputs

Rated data



Version	AI 4, 12 bits, 0/4 ... 20 mA	AI 2, 16 bits, -10 V ... 10 V	AI 2, 16 bits, 0/4 ... 20 mA
Order designation	EPM-S403	EPM-S406*	EPM-S408*
Function	4 analog inputs, Current measurement	2 analog inputs Voltage measurement bipolar, 16 bits	2 analog inputs, Current measurement, 16 bits
Current supply			
Backplane bus current consumption	70 mA		
I/O supply current consumption	15 mA		
Electrical isolation	500 V between backplane bus and I/O signal	500 V between backplane bus and I/O signal	500 V between backplane bus and I/O signal
Signal			
Number of inputs/outputs	4/-	2/-	2/-
Signal	0/4 ... 20 mA	-10 V DC ... +10 V DC	0/4 ... 20 mA
Filter	1 kHz		
Sensor			
Resolution	12 bits	16 bits	16 bits
Usage error margin	+0.3 % at 0 ... 20 mA, +0.5 % at 4 ... 20 mA		
Basic error margin (at 25 °C)	+0.2 % at 0 ... 20 mA, +0.3 % at 4 ... 20 mA		
A/D conversion time	8ms (all channels)		
Communication			
Width in the input process image	8 bytes		
Parameter data (PROFIBUS/PROFINET)	8 bytes		
Status display			
Module status	Ready for operation / error	Ready for operation / error	Ready for operation / error
Signal status	1 LED per channel	1 LED per channel	1 LED per channel
General			
Scope of supply	I/O compound module (base module + electronic module)	I/O compound module (base module + electronic module)	I/O compound module (base module + electronic module)
Packaging unit	1	1	1
Enclosure	IP20	IP20	IP20
Dimensions (height x width x depth)	100 x 12.5 x 76	100 x 12.5 x 76	100 x 12.5 x 76
Weight	0.06 kg	0.06 kg	0.06 kg
Wiring diagram			

* in preparation

Analog I/O

Outputs

Rated data



Version	AO 2, 12 bits, 0 ... 10 V	AO 4, 12 bits, 0 ... 10 V	AO 2, 12 bits, 0/4 ... 20 mA	AO 4, 12 bits, 0/4 ... 20 mA
Order designation	EPM-S500	EPM-S501	EPM-S502	EPM-S503
Function	2 analog outputs, voltage	4 analog outputs, voltage	2 analog outputs, current	4 analog outputs, current
Current supply				
Backplane bus current consumption	80 mA	80 mA	80 mA	80 mA
I/O supply current consumption	35 mA	35 mA	55 mA	95 mA
Electrical isolation	500 V between backplane bus and I/O level	500 V between backplane bus and I/O level	500 V between backplane bus and I/O level	500 V between backplane bus and I/O level
Signal				
Number of inputs/outputs	-/2	-/4	-/2	-/4
Signal	0 ... 10 V DC	0 ... 10 V DC	0/4 ... 20 mA	0/4 ... 20 mA
Resolution	12 bits	12 bits	12 bits	12 bits
Usage error margin	+/- 0.3 %	+/- 0.3 %	+/-0.4 % at 0 ... 20 mA, +/-0.5 % at 4 ... 20 mA	+/-0.4 % at 0 ... 20 mA, +/-0.5 % at 4 ... 20 mA
Basic error margin (at 25 °C)	+/- 0.2 %	+/- 0.2 %	+/-0.2 % at 0 ... 20 mA, +/-0.3 % at 4 ... 20 mA	+/-0.2 % at 0 ... 20 mA, +/-0.3 % at 4 ... 20 mA
D/A conversion time	2 ms (all channels)	2 ms (all channels)	2 ms (all channels)	2 ms (all channels)
Communication				
Width in the input process image	4 bytes	8 bytes	4 bytes	8 bytes
Parameter data (PROFIBUS/PROFINET)	8 bytes	10 bytes	8 bytes	10 bytes
Status display				
Module status	Ready for operation/error	Ready for operation/error	Ready for operation/error	Ready for operation/error
Signal status	1 LED per channel (overload, short circuit, parameterisation error)	1 LED per channel (overload, short circuit, parameterisation error)	1 LED per channel (overload, short circuit, parameterisation error)	1 LED per channel (overload, short circuit, parameterisation error)
General				
Scope of supply	I/O compound module (base module + electronic module)	I/O compound module (base module + electronic module)	I/O compound module (base module + electronic module)	I/O compound module (base module + electronic module)
Packaging unit	1	1	1	1
Enclosure	IP20	IP20	IP20	IP20
Dimensions (height x width x depth)	100 x 12.5 x 76	100 x 12.5 x 76	100 x 12.5 x 76	100 x 12.5 x 76
Weight	0.06 kg	0.06 kg	0.06 kg	0.06 kg
Wiring diagram				



Temperature measurement

Rated data



Version	AI 4, 16 bits, resistor	AI 2, 16 bits, thermocouple
Order designation	EPM-S404	EPM-S405
Function	2 or 4 analog inputs, temperature measurement based on resistance tests	2 analog inputs, temperature measurement with thermocouples, cold junction compensation by internal temperature measurement
Current supply		
Backplane bus current consumption	75 mA	75 mA
I/O supply current consumption	30 mA	30 mA
Electrical isolation	500 V between backplane bus and I/O signal	500 V between backplane bus and I/O signal
Signal		
Number of inputs/outputs	4(2)/-	2/-
Signal		
Measuring range	Temperature detection: PT100: -200 °C ... +850 °C PT1000: -200 °C ... +850 °C NI100: -60 °C ... +250 °C NI1000: -60 °C ... +250 °C Resistance test: 60 Ω 600 Ω 3000 Ω 6000 Ω	type J, -210.0 °C ... +1200.0 °C type K, -270.0 °C ... +1372.0 °C type N, -270.0 °C ... +1300.0 °C type R, -50.0 °C ... +1769.0 °C type S, -50.0 °C ... +1769.0 °C type T, -270.0 °C ... +400.0 °C type B, 0.0 °C ... +1820.0 °C type C, 0.0 °C ... +2315.0 °C type E, -270.0 °C ... +1000.0 °C type L, -200.0 °C ... +900.0 °C -80 mV ... +80 mV
Sensor	PT100, PT1000, NI100, NI1000, resistor	J, K, N, R, S, T, B, C, E, L
Resolution	16 bits	16 bits
Usage error margin	+/- 0.4 %	>= +/-1.5 K, depending on sensor and spurious frequency suppressor
Usage error margin (at 25°C)	+/- 0.2 %	>= +/-1 K, depending on sensor and spurious frequency suppressor
A/D conversion time		Depending on configuration and filter setting 4 ms – 325 ms
Connection system	2- (3-/4-wire conductor technology)	
Communication		
Width in the input process image	8 bytes	4 bytes
Parameter data (PROFIBUS/PROFINET)	34 bytes	22 bytes
Status display		
Module status	Ready for operation / error	Ready for operation / error
Signal status	1 LED per channel	1 LED per channel
General		
Scope of supply	I/O compound module (base module + electronic module)	I/O compound module (base module + electronic module)
Packaging unit	1	1
Enclosure	IP20	IP20
Dimensions (height x width x depth)	100 x 12.5 x 76	100 x 12.5 x 76
Weight	0.06 kg	0.06 kg
Wiring diagram		

Counter

Rated data



Version	Counter 1, 24 V DC	Counter 2, 24 V DC	Counter 1, 5 V DC	Counter 2, 24 V DC
Order designation	EPM-S600	EPM-S601	EPM-S602	EPM-S603
Function	1-slot counter 24 V with fast digital output	2-slot counter 24 V	1-slot counter 5 V	2-slot counter 24 V
Current supply				
Backplane bus current consumption	75 mA	75 mA	75 mA	100 mA
I/O supply current consumption	20 mA + current consumption of encoder	15 mA + current consumption of encoder	20 mA + current consumption of encoder	15 mA + current consumption of encoder
Electrical isolation	500 V between backplane bus and I/O signal	500 V between backplane bus and I/O signal	500 V between backplane bus and I/O signal	500 V between backplane bus and I/O signal
Signal				
Number of inputs/outputs	1/1	2/-	1/-	2/-
Level	HTL	HTL	TTL	HTL
Filter	1-100 kHz	1-100 kHz	1-500 kHz	1-100 kHz
Time stamp	Yes		Yes	
Counter frequency	400 kHz	400 kHz	2 MHz	400 kHz
Counter width	32 bits	32 bits	32 bits	32 bits
Counter function	Read, set, Latch function	Read, set	Read, set	Read
Alarm function	Yes	Yes	Yes	
Control inputs	Latch, reset, gate		Reset	
Rated voltage	24 V DC			
Output current per channel	0.5 A			
Communication				
Width in the input process image	12 bytes	12 bytes	8 bytes	12 bytes
Width in the output process image	10 bytes	12 bytes	10 bytes	4 bytes
Parameter data (PROFIBUS/PROFINET)	21 bytes	42 bytes	22 bytes	8 bytes
Status display				
Module status	Ready for operation/error	Ready for operation/error	Ready for operation/error	Ready for operation/error
Signal status	1 LED per counter input / control input / output	1 LED per counter input	1 LED per counter input	1 LED per counter input
General				
Scope of supply	I/O compound module (base module + electronic module)	I/O compound module (base module + electronic module)	I/O compound module (base module + electronic module)	I/O compound module (base module + electronic module)
Packaging unit	1	1	1	1
Enclosure	IP20	IP20	IP20	IP20
Dimensions (height x width x depth)	100 x 12.5 x 76	100 x 12.5 x 76	100 x 12.5 x 76	100 x 12.5 x 76
Weight	0.06 kg	0.06 kg	0.06 kg	0.06 kg

Wiring diagram

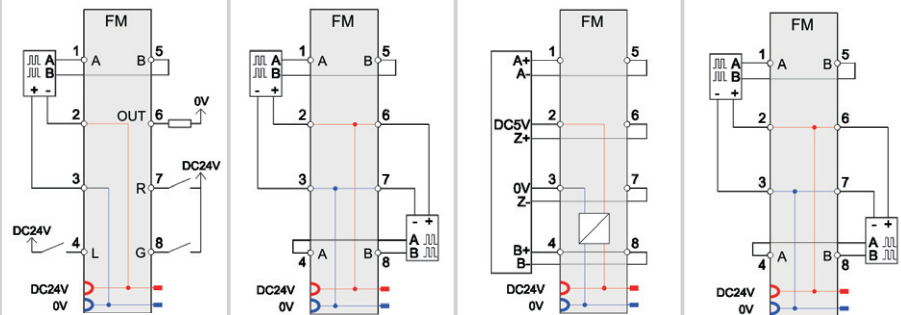



Encoder evaluation

Rated data

Version	 SSI
Order designation	EPM-S604
Function	SSI interface for the evaluation of encoder signals
Current supply	
Backplane bus current consumption	70 mA
I/O supply current consumption	30 mA
Electrical isolation	500 V between backplane bus and I/O signal
Signal	
Number of inputs/outputs	1/-
Level	RS 422
Encoder frequency	12 kHz - 6 MHz
Rated voltage of encoder signal	24 V DC
Evaluation function	3 comparisons, 2 limit values
Communication	
Width in the input process image	6 bytes
Parameter data (PROFIBUS/PROFINET)	33 bytes
Status display	
Module status	Ready for operation / error
Signal status	1 LED per encoder input signal
General	
Scope of supply	I/O compound module (base module + electronic module)
Packaging unit	1
Enclosure	IP20
Dimensions (height x width x depth)	100 x 12.5 x 76
Weight	0.06 kg

Wiring diagram

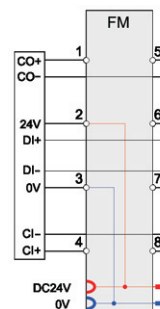

Technology modules

Rated data





Version	PWM	RS232
Order designation	EPM-S620	EPM-S640
Function	Output of pulse width modulated signals	Activation of devices with RS232 interface
Current supply		
Backplane bus current consumption	100 mA	100 mA
I/O supply current consumption		
Electrical isolation	500 V between backplane bus and I/O signal	500 V between backplane bus and I/O signal
Signal		
Number of inputs/outputs	-/2	
Rated voltage	24 V DC	
Output current per channel	0.5 A	
Output delay	1 μ s	
Short-circuit strength	Yes, electronic	
Level		RS 232
Max. cable length		
Switching frequency at ohmic load	20 kHz	
Communication		
Max. baud rate		115.2 kbps
Hardware handshake		RTS/CTS
Protocols		ASCII, STX/ETX
Transmit/receive buffer		
Width in the input process image	4 bytes	max. 60 bytes
Width in the output process image	12 bytes	max. 60 bytes
Parameter data (PROFIBUS/PROFINET)	8 bytes	17 bytes
Status display		
Module status	Ready for operation / error	Ready for operation / error
Signal status	1 LED per channel	1 TxD LED, 1 RxD LED
General		
Scope of supply	I/O compound module (base module + electronic module)	I/O compound module (base module + electronic module)
Packaging unit	1	1
Enclosure	IP20	IP20
Dimensions (height x width x depth)	100 x 12.5 x 76	100 x 12.5 x 76
Weight	0.06 kg	0.06 kg
Wiring diagram		



Power supply modules

Rated data

			
Version	Power BC	Power 24 V DC	Power 24 V / 24 V DC
Order designation	EPM-S700	EPM-S701	EPM-S702
Function	Main supply (bus coupler) as a spare part	I/O supply	I/O supply and electronic supply
Current supply			
Electronics supply voltage	24 V DC (20.4 ... 28.8 V)		24 V DC (20.4 ... 28.8 V)
Polarity reversal protection	Yes	Yes	Yes
Backplane bus current output	3 A		2 A
Fusing	Internal	Internal	Internal
I/O supply output voltage	24 V	24 V	24 V
I/O supply output current	10 A	10 A	4 A
Electrical isolation		No connection to the I/O supply voltage of the modules mounted at the side on the left	No connection to the I/O supply voltage of the modules mounted at the side on the left 500 V between I/O supply and electronic supply
Status display			
Voltage supply	Supply ok / fuse defective	Supply ok / fuse defective	Supply ok / fuse defective
General			
Scope of supply	Electronic module	I/O compound module	I/O compound module
Packaging unit	1	1	1
Enclosure	IP20	IP20	IP20
Dimensions (height x width x depth)	56 x 12.5 x 62	100 x 12.5 x 76	100 x 12.5 x 76
Weight	0.03 kg	0.06 kg	0.06 kg

Wiring diagram

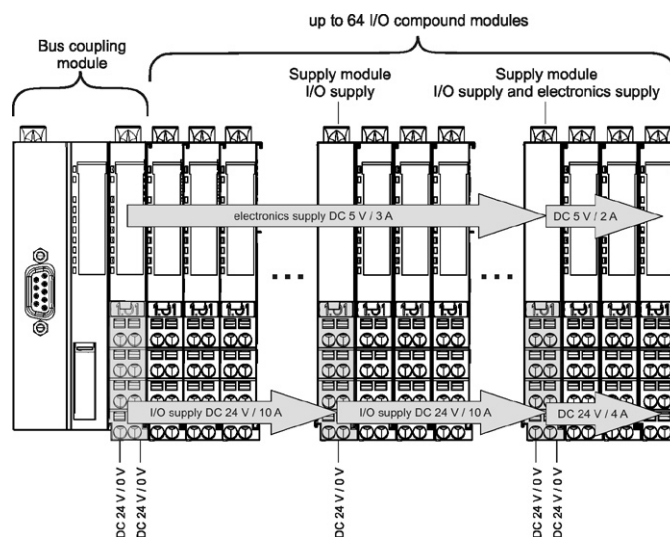

Power distributor modules

Rated data







Version	Supply 8 x DC 24 V	Supply 8 x DC 0 V	Supply 4 x DC 24 V / 0 V
Order designation	EPM-S910	EPM-S911	EPM-S912
Function	Power distributor 24 V	Power distributor 0 V	Power distributor 24 V / 0 V
Current supply			
Rated voltage	24 V	0 V	24 V / 0 V
Output current	10 A	10 A	10 A
General			
Scope of supply	I/O compound module	I/O compound module	I/O compound module
Packaging unit	1	1	1
Enclosure	IP20	IP20	IP20
Dimensions (height x width x depth)	100 x 12.5 x 53	100 x 12.5 x 53	100 x 12.5 x 53
Weight	0.05 kg	0.05 kg	0.05 kg
Wiring diagram			



Accessories

Order data

	Item/ description:	Order code
	Holders for the shield bus The holders enable installation of standard metal rails for the shield connection directly on the module (VPE 10 pieces)	EPM-S900
	"Node" CAN bus plug - Sub-D, 90° - Screw terminals	EPM-T950
	"Termination" CAN bus plug - Sub-D, 90° - Screw terminals - Integrated terminating resistor	EPM-T951
	"Straight" CAN bus plug CAN - Sub-D, 180° - Screw terminals - Switchable terminating resistor	EPM-T952
	"Switch" CAN bus plug - Sub-D, 90° - Tension spring terminal - Switchable terminating resistor	EWZ0046



Lenze worldwide

Lenze SE

Postfach 10 13 52
D-31763 Hameln
Telefon +49 (0)51 54 / 82-0
Telefax +49 (0)51 54 / 82-28 00
E-Mail: Lenze@Lenze.de
Internet: www.Lenze.com

Lenze Automation GmbH

Grünstraße 36, D-40667 Meerbusch
Telefon +49 (0)51 54 / 99 04-0
Telefax +49 (0)21 32 / 7 21 90
Standort:
Hans-Lenze-Straße 1, D-31855 Aerzen
Postfach 101352, D-31763 Hameln
Telefon +49 (0)51 54 / 82-0
Telefax +49 (0)51 54 / 82-28 00
Standort:
Am Alten Bahnhof 11
D-38122 Braunschweig
Telefon +49 (0)531 / 80178-0
Telefax +49 (0)531 / 80178-20

Lenze Drives GmbH

Postfach 10 13 52, D-31763 Hameln
Breslauer Strasse 3, D-32699 Extertal
Telefon +49 (0)51 54 / 82-0
Telefax +49 (0)51 54 / 82-28 00

Lenze Operations GmbH

Postfach 10 13 52, D-31763 Hameln
Hans Lenze Straße 1, D-31855 Aerzen
Telefon +49 (0)51 54 / 82-0
Telefax +49 (0)51 54 / 82-28 00

Lenze GmbH & Co KG Anlagenbau

Buchenweg 1
D-31855 Aerzen
Telefon +49 (0)51 54 / 82-0
Telefax +49 (0)51 54 / 82-21 00

Lenze Service GmbH

Breslauer Straße 3
D-32699 Extertal
Mechanical Drives
Telefon +49 (0)51 54 / 82-16 26
Telefax +49 (0)51 54 / 82-13 96
Electronic Drives
Telefon +49 (0)51 54 / 82-11 11
Telefax +49 (0)51 54 / 82-11 12
Service Helpline
+49 (0)180 5 20 24 26

Lenze Verbindungstechnik GmbH

IpF-Landesstraße 1
A-4481 ASTEN
Telefon +43 (0)72 24 / 210-0
Telefax +43 (0)72 24 / 210-998

Lenze DETO Drive Systems GmbH & Co KG

Untere Sparchen 16
A-6330 Kufstein
Telefon +43 (0)53 72 / 6 53 15-200
Telefax +43 (0)53 72 / 6 53 15-299

Schmidhauser AG

Obere Neustrasse 1
CH-8590 Romanshorn
Telefon +41 (0)71 466 11 11
Telefax +41 (0)71 466 11 10

encoway GmbH

Buschhöhe 2
D-28357 Bremen
Telefon +49 (0)4 21 / 33003 - 500
Telefax +49 (0)4 21 / 33003 - 555

DEUTSCHLAND/GERMANY

Lenze Vertrieb GmbH *

Ludwig-Erhard-Straße 52-56
D-72760 Reutlingen
Telefon +49 (0)71 21 / 9 39 39-0
Telefax +49 (0)71 21 / 9 39 39-29

Region Nord
HefeHof 25
31785 Hameln
Telefon (0 51 54) 82 44-0
Telefax (0 51 54) 82 44-44

Region West
Postfach 10 12 20
47497 Neukirchen-Vluyn
Kelvinstraße 7
47506 Neukirchen-Vluyn
Telefon (0 28 45) 95 93-0
Telefax (0 28 45) 95 93 93

Region Mitte/Ost
Postfach 1463
35724 Herborm
Austraße 81
35745 Herborm
Telefon (0 27 72) 95 94-0
Telefax (0 27 72) 95 94 94

Region Südwest
Postfach 14 33
71304 Waiblingen
Schänzle 8
71332 Waiblingen
Telefon (0 71 51) 9 59 81-0
Telefax (0 71 51) 9 59 81 50

Region Süd
Fraunhoferstraße 16
82152 Martinsried
Telefon (0 89) 89 56 14-0
Telefax (0 89) 89 56 14 14

WELTWEIT/WORLDWIDE

ALGERIA

see FRANCE

ARGENTINA *

E.R.H.S.A.
Girardot 1368, 1427 BUENOS AIRES
Phone +54 (0)11 / 45 54 32 32
Telefax +54 (0)11 / 45 52 36 11

AUSTRALIA *

FCR Motion Technology Pty. Ltd.
Unit 6, Automation Place
38-40 Little Boundary Rd.
LAVERTON NORTH, Vic. 3026
Phone +61 (3) 9362 6800
Telefax +61 (3) 9314 3744

AUSTRIA *

Lenze Antriebstechnik GmbH
IpF-Landesstraße 1
4481 ASTEN
Phone +43 (0)7224 / 210-0
Telefax +43 (0)7224 / 210-999
Office Dornbirn:
Lustenauer Straße 64
6850 DORNBIERN
Phone +43 (0)7224 / 210-0
Telefax +43 (0)7224 / 210-7299
Office Wr. Neudorf:
Triester Straße 14/109
2351 WR. NEUDORF
Phone +43 (0)7224 / 210-0
Telefax +43 (0)7224 / 210-7099
Office Graz:
Seering 8
8141 ÜNTERPREMSTÄTTEN
Phone +43 (0)7224 / 210-0
Telefax +43 (0)7224 / 210-7199
Lenze Verbindungstechnik GmbH
IpF-Landesstraße 1
4481 ASTEN
Phone +43 (0)7224 / 210-0
Telefax +43 (0)7224 / 210-998
Lenze Anlagentechnik GmbH
Mühlenstraße 3
4470 ENNS
Phone +43 (0)7224 / 210-0
Telefax +43 (0)7224 / 210-997

BELARUS

see POLAND

BELGIUM *

Lenze bv.ba
Industriepark Noord, 19.
9100 SINT-NIKLAAS
Phone +32 (0)3.542.62.00
Telefax +32 (0)3.541.37.54

BOSNIA-HERZEGOVINA

see AUSTRIA

BRAZIL *

Lenze Brasil Automação Ltda.
Rua Conde Moreira Lima 589
CEP 04384-030
SÃO PAULO/SP – Brasil
Phone +55 11 2348-6579
Telefax +55 11 2348-6573

Produtos Eletrônicos Metaltext Ltda (Focus on Sales)

Rua José Rafaelli, 221
Socorro, CEP 04763-280
SÃO PAULO/SP – Brasil
Phone +55 11 56 83 57 00
Telefax +55 11 55 24 23 24

BULGARIA

Lenze Zadvizhvasta Tehnika EOOD
Bul. Maritza 21, Office 204
4003 PLOVDIV
Phone +359 / 32 / 940 373
Telefax +359 / 32 / 940 349

CANADA *

Lenze Canada Corporation
1535 Meyerside Drive, Unit 1
Mississauga, ON L5T 1M9 CANADA
Phone +1 (508) 278-9100
Telefax +1 (508) 278-7873

CENTRAL AMERICA

see Americas HQ

CHILE

Sargent S.A.
Tecnica Thomas C. Sargent
Av. Gral. Velásquez 5720, San Bernardo
SANTIAGO – CHILE
Phone +56 (0)2 / 51 03 000
Telefax +56 (0)2 / 69 83 989

CHINA *

Lenze Drive Systems (Shanghai) Co. Ltd.
No. 2989, Jiangshan Road
Lingang, Shanghai 201306
CHINA
Phone +86 21 3828 0200
Telefax +86 21 3828 0250

COLOMBIA

Casa Sueca, S.A.
Calle 52 1N-74
CALI
Phone +57 -2- 682 0444
Telefax +57 -2- 683 1411

CROATIA

Lenze mehatronika-pogonska tehnika d.o.o.
Ulica grada Gospića 3
HR-10000 ZAGREB
Phone +385 1 249-8056
Telefax +385 1 249-8057

CZECH REPUBLIC

Lenze, s.r.o.
Central Trade Park D1
396 01 HUMPOLEC
Phone +420 565 507-111
Telefax +420 565 507-399
Büro Červený Kostelec:
17. listopadu 510
549 41 ČERVENÝ KOSTELEČ
Phone +420 491 467-111
Telefax +420 491 467-166

DENMARK *

Lenze A/S
Vallensbækvej 18A
2605 BRØNDBY
Phone +45 / 4696 6666
Telefax +45 / 4696 6660
24 stunde service +45 / 5251 6699
Buero Jylland: Lenze A/S
Niels Bohrs Vej 23
8660 SKANDERBORG
Phone +45 / 46 96 66 88
Telefax +45 / 46 96 66 80

EGYPT

WADI Co. for technologies
and development
P.O.Box 209, new center Ramses
11794 CAIRO, Egypt
11 Syria St., Mohandessin
GIZA, Egypt
Phone +2 (02) 3347 6842
Telefax +2 (02) 3347 6843

ESTONIA

see FINLAND

FINLAND *

Lenze Drives
Tierankatu 8, 20520 TURKU
Phone +358 2 2748 180
Telefax +358 2 2748 189

FRANCE *

Lenze S.A.
Siège
ZI des Mardelles
44 Rue Blaise Pascal
93600 AULNAY-SOUS-BOIS
Services Commerciaux
Phone 0 825 086 036
Telefax 0 825 086 346
Centre de formation
E-Mail : semin.sidonie@lenze.fr
Questions générales / documentation
E-Mail : info@lenze.fr
Service Après-vente / assistance en ligne
Helpline 24/24 : 0 825 826 117
E-Mail : helpline@lenze.fr

Agences en France

Région France Nord :
ZI des Mardelles
44 Rue Blaise Pascal
93600 AULNAY-SOUS-BOIS
Nantes
44000 NANTES
Strasbourg
67870 GRIESHEIM près MOLSHEIM
Rouen
76500 ELBEUF

Région France Sud :

Parc Technologique
97, allée Alexandre Borodine
Immeuble le Douglas 2
69800 SAINT PRIEST

Agen

47270 SAINT-PIERRE de CLAIRAC

GREECE

GEORGE P. ALEXANDRIS SA
12, K. Mavromichali Street
18545 PIRAEUS
Phone +30 210 41 11 841
Telefax +30 210 41 27 058

Industrial Area, Block 48B, 4th Entrance

57022 SINDOS
Phone +30 2310 556 650
Telefax +30 2310 511 815

HUNGARY *

Lenze Hajtástechnika Kft
2040 BUDAÖRS
Gyár utca 2., P.O.Box 322.
Phone +36 (0)23 / 501-320
Telefax +36 (0)23 / 501-339

ICELAND

see DENMARK



INDIA

Lenze Mechatronics Pvt. Ltd.
Lenze Plot No. 46A, Sector-10
PCNTDA Industrial Area, Bhosari
PUNE - 411 026
Phone +91-20-66318100
Telefax +91-20-66318120

Kolkata Sales office
2nd Floor, 3/1 Ashton Road
KOLKATA - 700020
Phone +91-33-24190490
Telefax +91-33-24190562

New Delhi Sales office
Flat No - 101, Padma Tower - II
22, Rajendra Place
NEW DELHI - 110008
Phone +91-11-25812113/15
Telefax +91-11-25812114

INDONESIA

see MALAYSIA

IRAN

Tavan Ressian Co.
P.O.Box 19395-5177
No. 18, Sh. Bakhtiaty Str.
South sh. Ghalandari Ave.
Sadr High way, TEHRAN
Phone +98-(21)-2260 6766
-2260 2655
-2260 9299
Telefax +98-(21)-2200 2883

ISRAEL *

Zeev Melcer LTD
P.O.B. 10011, HAIFA BAY 26110
36 Yosef Levi St., Kiriat Bialik
Phone +972-(0)4-8757037
Telefax +972-(0)4-8742172

ITALY *

Lenze Italia S.r.l.
Viale Monza 338, 20128 MILANO
Phone +39 02 / 270 98.1
Telefax +39 02 / 270 98 290

JAPAN *

Miki Pulley Co., Ltd.
1-39-7 Komatsubara, Zama-city
KANAGAWA 228-8577
Phone +81 (0)462 / 58 16 61
Telefax +81 (0)462 / 58 17 04

LATVIA

see LITHUANIA

LEBANON

I. Network Automation s.a.l.
Ground floor - United insurance building
Facing Mercedes Show room
Dora - High Way, BEIRUT-METEN
P.O.Box 835 - Jounieh - Lebanon
Phone +961-1-249562
Telefax +961-1-249563

LITHUANIA

Lenze UAB
Breslaujos g.3, 44403 KAUNAS
Phone +370 37 407174
Telefax +370 37 407175

LUXEMBOURG *

see BELGIUM

MACEDONIA

Lenze Antriebs Technik GmbH
Pretstavnistvo Skopje
ul. Nikola Rusinski 3/A/2, 1000 SKOPIJE
Phone +389 2 30 90 090
Telefax +389 2 30 90 091

MALAYSIA

Lenze S.E.A. Sdn Bhd
No. 28 Jalan PJU 3/47
Sunway Damansara, Technology Park
47810 PETALING JAYA
SELANGOR DARUL EHSAN
Phone +60 3 7803 1428
Telefax +60 3 7806 3728

MAURITIUS

Automation & Controls Engineering Ltd
3, Royal Road, Le Hochet, Terre Rouge
MAURITIUS
Phone +230 248 8211
Telefax +230 248 8968

MEXICO

Sales:
see AMERICAS HQ

Service:
**Automatización y Control
de Energía S.A. de C.V.**
Av. 2 No.89 Esq Calle 13
Col. San Pedro de los Pinos
C.P. 03800 MEXICO D.F.
Phone +52 55 2636-3540
Fax +52 55 2636-3541

MONTENEGRO

see MACEDONIA

MOROCCO

GUORFET G.T.D.R
Automatisation Industrielle
Bd Chefchaouni Route 110 km, 11.500
No. 353-Aïn-Sabaâ
CASABLANCA
Phone +212/22-35 70 78
Telefax +212/22-35 71 04

NETHERLANDS *

Lenze B.V., Postbus 31 01
5203 DC'S-HERTOGENBOSCH
Ploegweg 15
5232 BR 'S-HERTOGENBOSCH
Phone +31 (0)73 / 64 56 50 0
Telefax +31 (0)73 / 64 56 51 0

NEW ZEALAND *

Tranz Corporation
343 Church Street
P.O. Box 12-320, Penrose
AUCKLAND
Phone +64 (0)9 / 63 45 51 1
Telefax +64 (0)9 / 63 45 51 8

NORWAY *

Dtc- Lenze as
Stallbakken 5, 2005 RAEILINGEN
Phone +47 / 64 80 25 10
Telefax +47 / 64 80 25 11

PHILIPPINES

see MALAYSIA

POLAND

Lenze Polska Sp. z o.o.
Ul. Rozdzińskiego 188b
40-203 KATOWICE
Phone +48 (0) 32 203 97 73
Telefax +48 (0) 32 781 01 80
Torun Office
Lenze Polska Sp. z o.o.
Ul. Rydygiera 47
87-100 TORUN
Phone +48 (0) 56 658 28 00
Telefax +48 (0) 56 645 33 56

PORTUGAL *

Costa Leal el Victor
Electronica-Pneumatica, Lda.
Rua Prof. Augusto Lessa, 269,
Apart. 52053
4202-801 PORTO
Phone +351-22 / 5 50 85 20
Telefax +351-22 / 5 02 40 05

ROMANIA

see AUSTRIA

RUSSIA

OOO Lenze
Shcheklovskoye shosse 5
105122 MOSCOW
Phone +7 495 921 3250
Telefax +7 495 921 3259

SERBIA

see MACEDONIA

SINGAPORE *

see MALAYSIA

SLOVAC REPUBLIC

ECS Sluzby spol. s.r.o.
Staromlynska 29
82106 BRATISLAVA
Phone +421 2 45 25 96 06
+421 2 45 64 31 47
+421 2 45 64 31 48
Telefax +421 2 45 25 96 06

SLOVENIA

LENZE GmbH, Asten, Avstrija
Podružnica Celje
Kidričeva 24
3000 CELJE
Phone +386 03 426 46 40
Telefax +386 03 426 46 50

SOUTH AFRICA *

S.A. Power Services (Pty) Ltd.
Unit 14, Meadowbrook Business Estates
Jacaranda Ave, Olivedale
Randburg 2158, P.O.Box 1137
RANDBURG 2125
Phone +27(11) 462-8810
Telefax +27(11) 704-5775

SOUTH KOREA *

Lenze Representative Office
No. 606, Daeryung Technotown 6th,
493-6, Gasan-dong, Geumcheon-gu,
SEOUL 153-774
Phone +82 2-792-7017
Telefax +82 2-792-7018

SPAIN *

Lenze Transmisiones S.A.
Edificio TCA
C/ Henri Dunant, 9.
08173 SANT CUGAT DEL VALLÈS
(Barcelona)
Phone 902 02 79 04
(0034) 937 207 680
Telefax 902 02 63 69

Lenze Delegación Norte
Phone 902 02 79 04
(0034) 937 207 680

Lenze Delegación Levante
Cullera, 73- 4ºD
46035 BENIMAMET (Valencia)
Phone 902 02 79 04
(0034) 937 207 680
Telefax 902 02 63 69

Lenze Delegación Madrid
C/ Poema Sinfónico Nº 25-27
Local nº 3, escalera 1, Planta Baja.
28054 MADRID
Phone 915 103 341
Telefax 915 102 061

SWEDEN *

Lenze Transmisioner AB
P.O.Box 10 74, Attorpsgatan, Tornby Ind.
58110 LINKÖPING
Phone +46 (0)13 / 35 58 00
Telefax +46 (0)13 / 10 36 23

SWITZERLAND *

Lenze Bachofen AG
Ackerstrasse 45
8610 USTER
Phone +41 (0) 43 399 14 14
Telefax +41 (0) 43 399 14 24

Vente Suisse Romande:
Route de Prilly 25
1023 CRISSIER
Phone +41 (0)21 / 63 72 19 0
Telefax +41 (0)21 / 63 54 76 2

SYRIA

Zahabi Co.
8/5 Shouhadaa Street
P.O.Box 8262
ALEPPO-SYRIA
Phone +963 21 21 22 23 5
Telefax +963 21 21 22 23 7

TAIWAN *

Lenze Taiwan Representative Office
6F-1, No.136, Sec. 3, Zhongxiao E. Rd.
TAIPEI City, 10655, Taiwan
Phone +886 / (0)2-2721-2161
Telefax +886 / (0)2-2721-2706

THAILAND

see MALAYSIA

TUNESIA

AMF Industrielle Sarl
Route de Gremda - Km 0,2
Immeuble El Madina,
Centre Bloc B - 5 ème - appt 52
3002 SFAK
Phone +216 74 403 514
Telefax +216 74 403 516

TURKEY

LSE Elektrik
Elektronik Makina
Etomasyon Mühendislik
Sanayi ve Ticaret Ltd. Şti
Atatürk mah. Cumhuriyet cad.
Yurt sok. No: 7
ÜMRANIYE/İSTANBUL
Phone +90 (0)216 / 316 5138 pbx
Telefax +90 (0)216 / 443 4277

UKRAINE

SV Altera, Ltd.
Lepse ave., 4
KIEV, 03067
Phone +38 044 496 18 88
Telefax +38 044 496 18-18

UNITED ARAB EMIRATES

LPT (FZC)
X4 Building No. 37
Sharjah Airport Free Zone (SALF ZONE)
SHARJAH
Phone +971 6 5573205
Telefax +971 6 5573206

UNITED KINGDOM/EIRE *

Lenze Ltd.
Fraser Road
Priory Business Park
BEDFORD MK44 3WH
Phone +44 (0)1234 / 75 32 00
Telefax +44 (0)1234 / 75 32 20

USA *

AMERICAS HQ
Lenze Americas Corporation
630 Douglas Street
UXBRIDGE, MA 01569
Phone +1 508 278 9100
Telefax +1 508 278 7873

Sales:
see Americas HQ

Operations:
Lenze AC Tech Corporation
630 Douglas Street
UXBRIDGE, MA 01569
Phone +1 508 278 9100
Telefax +1 508 278 9294

Lenze DETO Drive Systems
see Americas HQ

VIETNAM

see MALAYSIA

* Countries connected to the free expert helpline 008000 24 hours (008000 24 46877)

It's good to know | why we are there for you



"Our customers come first. Customer satisfaction is what motivates us. By thinking in terms of how we can add value for our customers we can increase productivity through reliability."



"We will provide you with exactly what you need – perfectly co-ordinated products and solutions with the right functions for your machines and installations. That is what we mean by 'quality'."



"Take advantage of our wealth of expertise. For more than 60 years now we have been gathering experience in various fields and implementing it consistently and rigorously in our products, motion functions and pre-configured solutions for industry."



"The world is our marketplace. Wherever you are in the world, we are nearby, providing you with our drive and automation solutions."

Algeria · Argentina · Australia · Austria · Belarus · Belgium · Bosnia-Herzegovina · Brazil · Bulgaria · Canada · Central America · Chile · China · Colombia · Croatia · Czech Republic · Denmark · Egypt · Estonia · Finland · France · Germany · Greece · Hungary · Iceland · India · Indonesia · Iran · Israel · Italy · Japan · Latvia · Lebanon · Lithuania · Luxembourg · Macedonia · Malaysia · Mauritius · Mexico · Montenegro · Morocco · Netherlands · New Zealand · Norway · Philippines · Poland · Portugal · Romania · Russia · Serbia · Singapore · Slovak Republic · Slovenia · South Africa · South Korea · Spain · Sweden · Switzerland · Syria · Taiwan · Thailand · Tunisia · Turkey · Ukraine · United Arab Emirates · United Kingdom/Eire · USA · Vietnam

You can rely on our service. Expert advice is available 24 hours a day, 365 days a year, in more than 30 countries via our international helpline: 008000 24 Hours (008000 2446877).

www.Lenze.com

13377367