

CHIORINO[®]
1906

Passion for belting

Timing belts

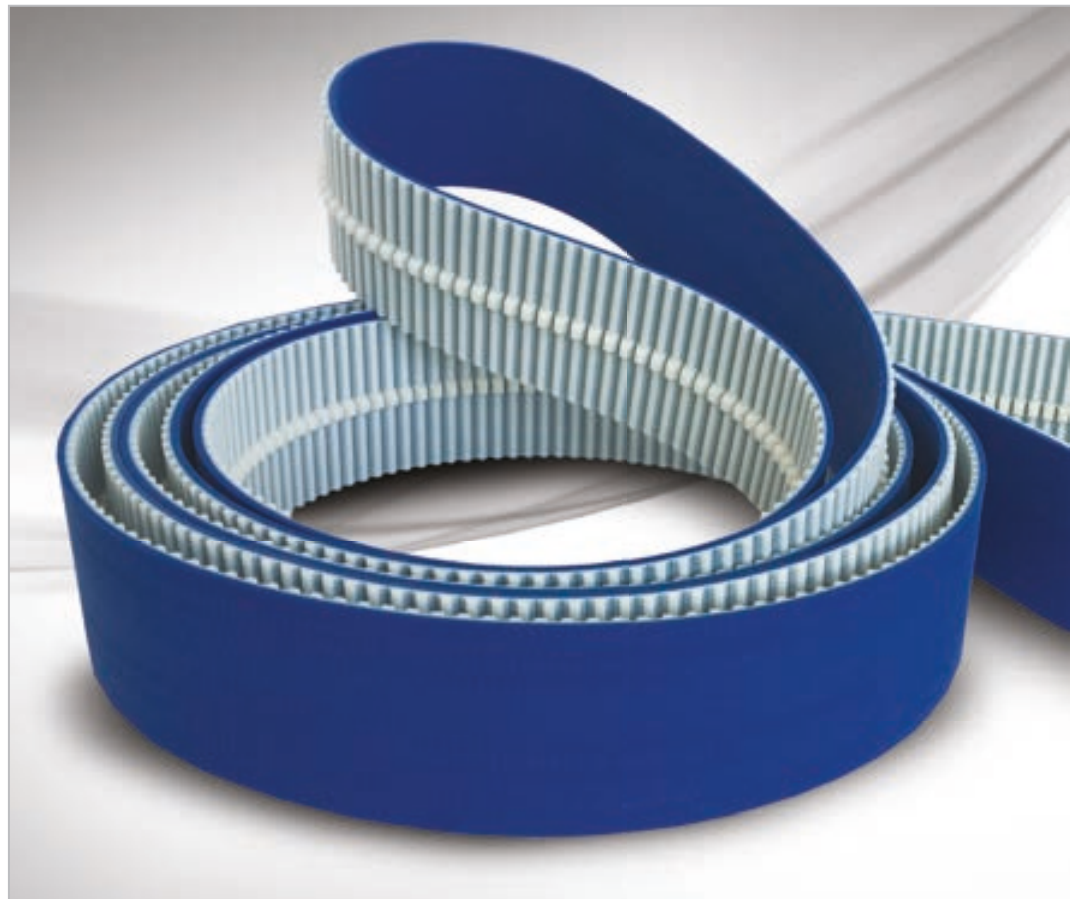

CHIORINO S.p.A. founded in Biella in 1906 is an international leading company in the full-cycled production of conveyor and transmission belts. During January 2011 CHIORINO S.p.A. – started production and distribution of TIMING BELTS among the whole CHIORINO Group.

The company

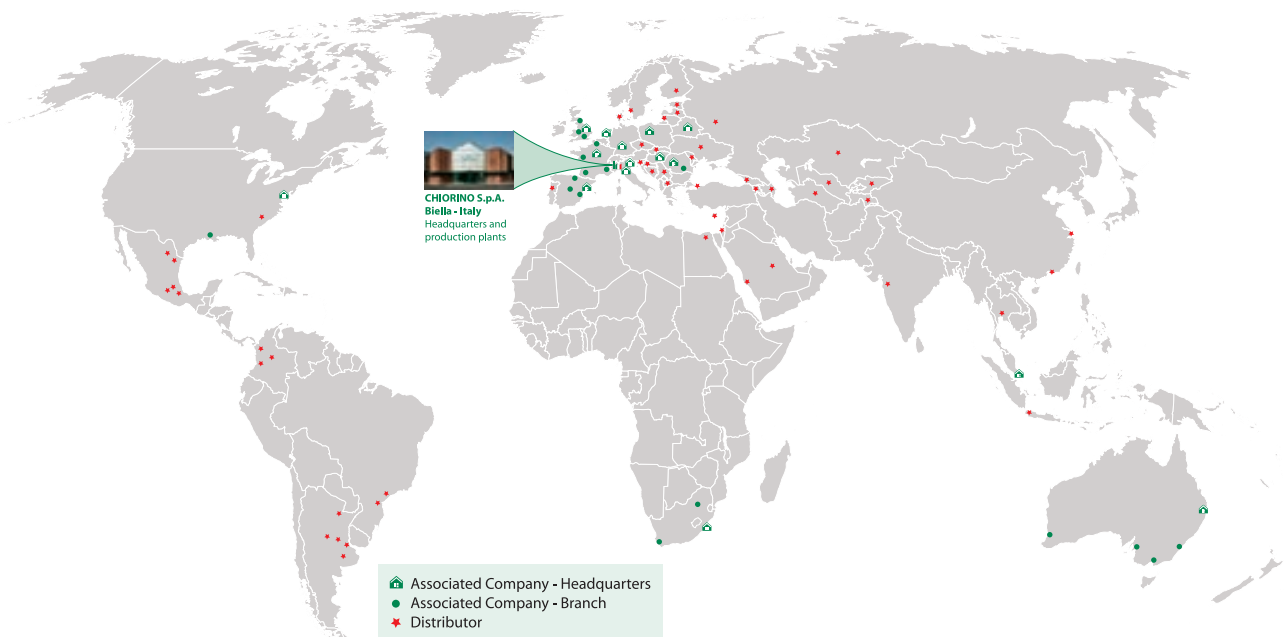

Specialization, flexibility, continuous technology update, are the market requirements. CHIORINO is the solution. Consistently answering the market needs with the ability to offer products that must be “state of the art” of the technology from every aspect.

This is why CHIORINO is a Global Reference Supplier for any requirement for CONVEYOR and PROCESS BELTS, FLAT TRANSMISSION BELTS and RUBBER APRONS. Components that must assure and ensure the most reliable product handling of all kinds in all situations.

Since January 2011 CHIORINO has enlarged its range of products, offering customers POLYURETHANE and RUBBER TIMING BELTS. Special belts with a variety of covers are available at the request of the customer with Ground finish and/or holes if required. This is the CHIORINO philosophy: “total quality” in order to be able to offer the right solutions to specific needs.

Quality and Service is our Driving Force!

Timing Belts for mechanical drives and conveying applications. Timing Belts provide a simple, functional approach to solve your technical problems for driving systems and conveying of goods. The timing belts within our product range are made either from Polyurethane or Rubber. The carcass construction in the Polyurethane belt is based on Kevlar or Steel cords. The Rubber timing belts are provided with a Fiberglass cord. The construction assures a high dynamic performance with low performance losses.

4	Chiorino Polyurethane Timing Belts
7	Chiorino Polyurethane open-end Timing Belts
14	Chiorino Endless Belts
18	Flexibility
21	Chiorino Rubber Timing Belts
34	V Belts
35	Poly V Belts
36	Coatings
42	Pulleys

CHIORINO Polyurethane truly endless Timing Belts are characterized by high power transmission capabilities. The construction of the belt enables a maintenance free operation. The application of belts is possible in environments with high temperature variation. For detailed technical information please contact our technical support.

Chiorino Polyurethane Timing Belts

T2,5

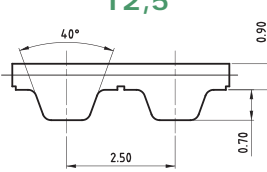

Number of teeth z	Length [mm]
48	120
58	145
64	160
71	177,5
72	180
80	200
84	210
92	230
98	245
106	265
111	277,5
114	285
116	290
122	305
127	317,5
132	330
137	342,5
152	380
168	420
192	480
200	500
216	540
240	600
260	650
312	780
366	915
380	950
590	1475

T5

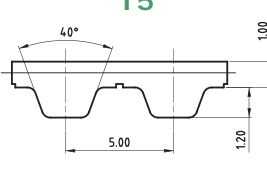

Number of teeth z	Length [mm]
33	165
37	185
40	200
43	215
44	220
45	225
49	245
50	250
51	255
52	260
54	270
55	275
56	280
59	295
60	300
61	305
64	320
65	325
66	330
68	340
70	350
71	355
72	360
73	365
75	375
78	390
80	400
82	410
84	420
85	425
86	430
88	440
89	445
90	450
91	455
92	460
95	475

T5

Number of teeth z	Length [mm]
96	480
100	500
102	510
105	525
109	545
110	550
112	560
115	575
118	590
120	600
122	610
124	620
125	625
126	630
128	640
130	650
132	660
135	675
138	690
140	700
144	720
145	725
150	750
156	780
160	800
163	815
168	830
168	840
170	850
172	860
180	900
188	940
198	990
200	1000
215	1075
220	1100
223	1115
228	1140
240	1200
243	1215
263	1315
270	1350

T5

Number of teeth z	Length [mm]
271	1355
276	1380
288	1440

DT5

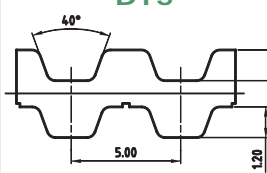

Number of teeth z	Length [mm]
82	410
92	460
118	590
124	620
150	750
163	815
172	860
188	940
220	1100



Chiorino Polyurethane Timing Belts

T10

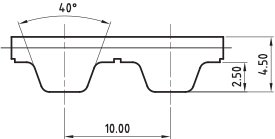

Number of teeth z	Length [mm]
26	260
32	320
35	350
37	370
40	400
41	410
44	440
45	450
48	480
50	500
53	530
55	550
56	560
60	600
61	610
63	630
65	650
66	660
69	690
70	700
72	720
75	750
78	780
80	800
81	810
84	840
85	850
88	880
89	890
90	900
91	910
92	920

T10

Number of teeth z	Length [mm]
95	950
96	960
97	970
98	980
100	1000
101	1010
105	1050
108	1080
110	1100
111	1110
114	1140
115	1150
120	1200
121	1210
124	1240
125	1250
130	1300
132	1320
135	1350
139	1390
140	1400
142	1420
144	1440
145	1450
146	1460
150	1500
156	1560
160	1600
161	1610
170	1700
175	1750
178	1780
180	1800
188	1880
196	1960
225	2250

DT10

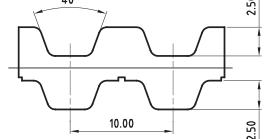

Number of teeth z	Length [mm]
26	260
53	530
63	630
66	660
72	720
84	840
92	920
98	980
121	1210
124	1240
125	1250
132	1320
135	1350
142	1420
161	1610
188	1880

T10 - VACUUM

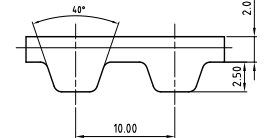

Number of teeth z	Length [mm]
63	630
92	920

AT5

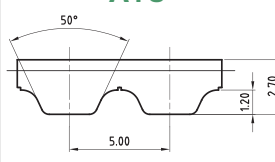

Number of teeth z	Length [mm]
45	225
51	255
56	280
60	300
68	340
75	375
78	390
84	420
90	450
91	455
100	500
109	545
120	600
122	610
132	660
142	710
144	720
150	750
156	780
165	825
172	860
195	975
210	1050
225	1125
300	1500

AT10

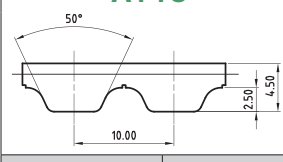

Number of teeth z	Length [mm]
50	500
53	530
56	560
58	580
60	600
61	610
66	660
70	700
73	730
78	780
80	800
84	840
88	880
89	890
92	920
96	960
98	980
100	1000
101	1010
105	1050
108	1080
110	1100
115	1150
120	1200
121	1210
125	1250
128	1280
130	1300
132	1320
135	1350
136	1360
140	1400
142	1420
148	1480
150	1500
160	1600
170	1700
172	1720
180	1800
186	1860
194	1940

L

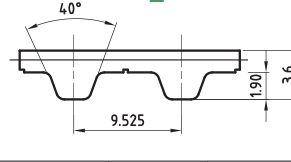

Type	Number of teeth z	Length [mm]
150 L	40	381,00
225 L	60	571,50
240 L	64	609,60
255 L	68	647,70
270 L	72	685,80
285 L	76	723,90
300 L	80	762,00
345 L	92	876,30
367 L	98	933,45
390 L	104	990,60
420 L	112	1066,80
510 L	136	1295,40
540 L	144	1371,60

XL

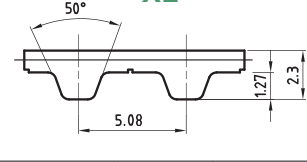

Type	Number of teeth z	Length [mm]
60 XL	30	152,40
70 XL	35	177,80
80 XL	40	203,20
90 XL	45	228,60
100 XL	50	254,00
110 XL	55	279,40
120 XL	60	304,80
130 XL	65	330,20
140 XL	70	355,60
150 XL	75	381,00
160 XL	80	406,40
170 XL	85	431,80
180 XL	90	457,20
190 XL	95	482,60
200 XL	100	508,00
210 XL	105	533,40
220 XL	110	558,80
230 XL	115	584,20
240 XL	120	609,60



CHIORINO Polyurethane open-ended Timing Belts assure high quality due to tight tolerance and excellent dimensional stability. On request the addition of a polyamide coating on the back and/or tooth face is possible during production. Open-end polyurethane timing belts can be supplied as open length rolls, or as endless jointed belts.

Chiorino Polyurethane Open-end Timing Belts

T2,5	T5	TT5	T10	T20
Std. width (mm)	Std. width (mm)	Std. width (mm)	Std. width (mm)	Std. width (mm)
4	10	10	10	25
6	12		16	32
10	16		20	50
20	20		25	75
50	25		32	100
100	32		50	150
	50		75	
	75		100	
	100		150	

P	2,50	P	5,00	P	5,00	P	10,00	P	20,00
H	1,60	H	2,20	H	2,80	H	4,50	H	8,00
H ₁	0,70	H ₁	1,20	H ₁	1,20	H ₁	2,50	H ₁	5,00

T2,5 - T5 - TT5 - T10 - T20

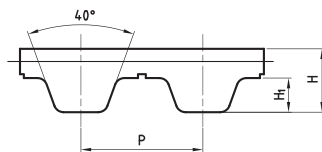

AT3 - AT5 - AT10 - AT20

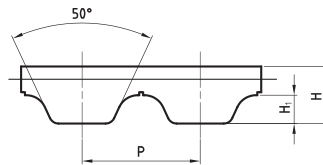

AT3	AT5	AT10	AT20
Std. width (mm)	Std. width (mm)	Std. width (mm)	Std. width (mm)
8	10	10	25
10	12	16	32
16	16	25	50
20	20	32	75
25	25	50	100
	32	75	150
	50	100	
	75	150	
	100		

P	3,00	P	5,00	P	10,00	P	20,00
H	1,90	H	2,70	H	4,50	H	8,00
H ₁	1,10	H ₁	1,20	H ₁	2,50	H ₁	5,00



ATL5 - ATL10 - ATL20

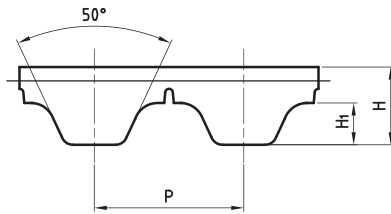

ATL5	ATL10	ATL20
Std. width (mm)	Std. width (mm)	Std. width (mm)
10	10	25
12	16	32
16	25	50
20	32	75
25	50	100
32	75	150
50	100	
75	150	
100		

P	5,00	P	10,00	P	20,00
H	2,70	H	4,80	H	8,40
H ₁	1,20	H ₁	2,50	H ₁	5,00

TK5-K6 TK10-K6 ATK5-K6

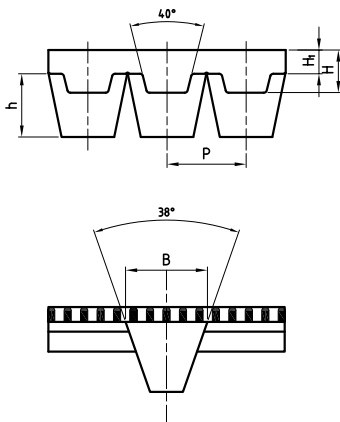

Pulleys profile K6

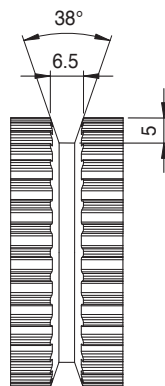

TK5-K6	TK10-K6	ATK5-K6
Std. width (mm)	Std. width (mm)	Std. width (mm)
16	32	16
25	50	25
32	75	32
50	100	50
75	150	75
100		100

P	5,00	P	10,00	P	5,00
H	2,20	H	4,50	H	2,70
H ₁	1,00	H ₁	2,50	H ₁	1,50
B	6,00	B	6,00	B	6,00
h	4,00	h	4,00	h	4,00

TK10-K13 ATK10-K13

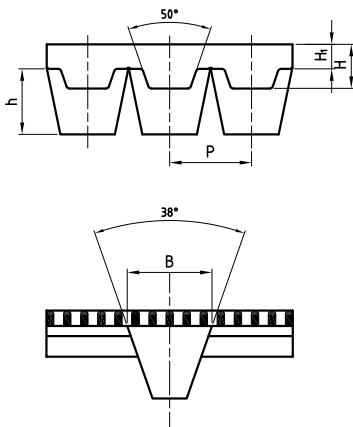

Pulleys profile K13

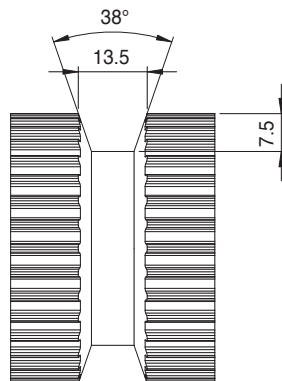

TK10-K13	ATK10-K13
Std. width (mm)	Std. width (mm)
25	25
32	32
50	50
75	75
100	100
	150

P	10,00	P	10,00
H	4,50	H	4,50
H ₁	2,00	H ₁	2,00
B	13,00	B	13,00
h	6,50	h	6,50

Chiorino Polyurethane Open-end Timing Belts

HTD3M - HTD5M - HTD8M - HTD14M

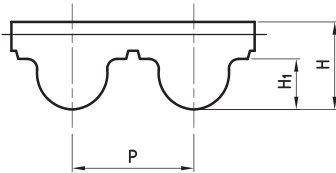

HTD3M	HTD5M	HTD8M	HTD14M
Std. width (mm)	Std. width (mm)	Std. width (mm)	Std. width (mm)
10	10	10	40
15	15	15	55
25	25	20	85
50	50	30	100
100	100	50	115
		85	150
		100	

P	3,00	P	5,00	P	8,00	P	14,0
H	2,40	H	3,70	H	5,60	H	10,00
H ₁	1,21	H ₁	2,10	H ₁	3,38	H ₁	6,01

STD5M - STD8M - STD14M

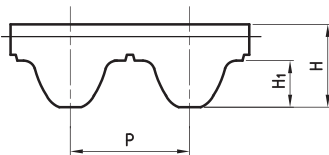

STD5M	STD8M	STD14M
Std. width (mm)	Std. width (mm)	Std. width (mm)
10	10	40
15	15	55
25	20	85
50	30	100
100	50	115
	85	
	100	

P	5,00	P	8,00	P	14,00
H	3,35	H	5,30	H	10,20
H ₁	1,85	H ₁	3,05	H ₁	5,30

XL

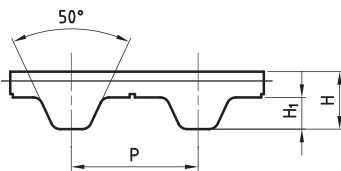

MXL - L - H - XH

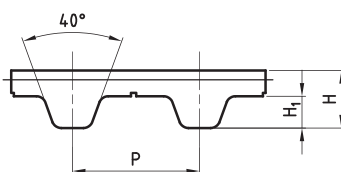

MXL	XL	L	H	XH
Std. width (in/mm)	Std. width (in/mm)	Std. width (in/mm)	Std. width (in/mm)	Std. width (in/mm)
025"/6,35	025"/6,35	050"/12,70	050"/12,70	100"/25,40
050"/12,70	037"/9,398	075"/19,05	075"/19,05	150"/38,10
100"/25,40	050"/12,70	100"/25,40	100"/25,40	200"/50,80
200"/50,80	075"/19,05	150"/38,10	150"/38,10	300"/76,20
400"/101,6	100"/25,40	200"/50,80	200"/50,80	400"/101,60
	150"/38,10	300"/76,20	300"/76,20	
	200"/50,80	400"/101,6	400"/101,60	
	400"/101,6		600"/152,40	
			800"/203,20	

P	2,032	P	5,08	P	9,525	P	12,70	P	22,225
H	1,55	H	2,30	H	3,61	H	4,29	H	6,35
H ₁	0,51	H ₁	1,27	H ₁	1,91	H ₁	2,29	H ₁	11,20

F1 - F2 - F2,5 - F3 - F8 - F9

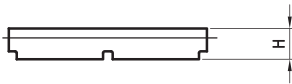

F1	F2	F2,5	F3	F8	F9
Std. width (in/mm)	Std. width (in/mm)	Std. width (in/mm)	Std. width (in/mm)	Std. width (in/mm)	Std. width (in/mm)
10	10	20	25	60	105
20	15	25	30	120	125
25	25	50	60		150
50	30	75	120		
75	50	100			
100	75	120			
	100				

H 1,00	H 2,00	H 2,50	H 3,00	H 8,00	H 8,75
--------	--------	--------	--------	--------	--------

Eagle profile 5M - 8M - 10M - 14M

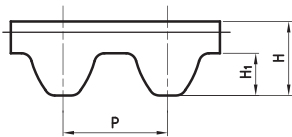

Eagle 5M	Eagle 8M	Eagle 10M	Eagle 14M
Std. width (mm)	Std. width (mm)	Std. width (mm)	Std. width (mm)
12,5	16	25	32
25	25	32	52,5
	32	50	70
	50	75	105
		100	

P 5,00	P 8,00	P 10,00	P 14,00
H 3,60	H 5,33	H 6,10	H 8,64
H ₁ 1,91	H ₁ 3,05	H ₁ 3,90	H ₁ 5,30

RTD 5M - RTD 8M - RTD 14M
RTD 14M XHPL

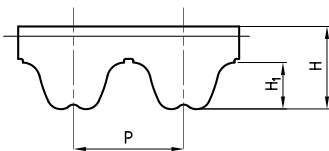

RTD 5M	RTD 8M	RTD 14M	RTD 14M XHPL
Std. width (mm)	Std. width (mm)	Std. width (mm)	Std. width (mm)
10	10	40	40
15	15	55	55
25	20	85	85
30	30	115	115
50	50		150
100	85		
	100		

P 5,00	P 8,00	P 14,00	P 14,00
H 3,80	H 5,40	H 9,70	H 10,40
H ₁ 2,05	H ₁ 3,20	H ₁ 5,85	H ₁ 5,85

RTD 14 M XHPL is ideal belt for heavy duty synchronous lifting applications. Black colour as standard.

Chiorino Polyurethane Open-end Timing Belts

T5DD - T10DD - T20DD

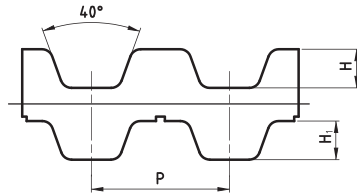

AT5DD - AT10DD - AT20DD

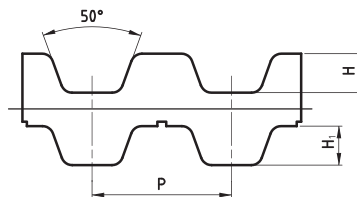

T5 DD	T10 DD	T20 DD	AT5 DD	AT10 DD	AT20 DD
Std. width (mm)	Std. width (mm)	Std. width (mm)	Std. width (mm)	Std. width (mm)	Std. width (mm)
10	10	-	10	-	-
16	16	-	16	16	-
25	25	25	25	25	25
32	32	-	32	32	32
50	50	50	50	50	50
75	75	75	75	75	75
100	100	100	100	100	100
	150	150		150	150

P	5,00	P	10,00	P	20,00	P	5,00	P	10,00	P	20,00
H	1,20	H	2,50	H	5,00	H	1,20	H	2,50	H	5,00
H ₁	1,20	H ₁	2,50	H ₁	5,00	H ₁	1,20	H ₁	2,50	H ₁	5,00

HTD5MDD - HTD8MDD - HTD14MDD

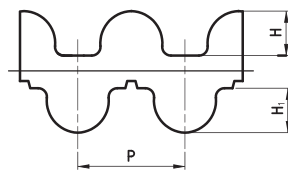

RTD5MDD - RTD8MDD

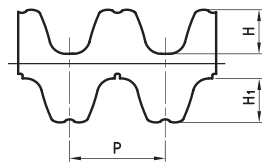

HTD5M DD	HTD8M DD	HTD14M DD	RTD 8M DD	RTD 14M DD
Std. width (mm)	Std. width (mm)	Std. width (mm)	Std. width (mm)	Std. width (mm)
10	10	40	10	40
15	15	55	15	55
25	20	85	20	85
50	30	100	30	115
100	50	115	50	
	85	150	85	
	100		100	

P	5,00	P	8,00	P	14,00	P	8,00	P	14,00
H	2,10	H	3,38	H	6,00	H	3,20	H	6,00
H ₁	2,10	H ₁	3,38	H ₁	6,00	H ₁	3,20	H ₁	6,00

LDD - HDD

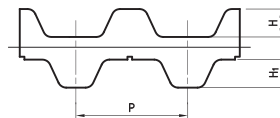

L DD	H DD
Std. width (in/mm)	Std. width (in/mm)
050"/12,70	050"/12,70
075"/19,05	075"/19,05
100"/25,40	100"/25,40
150"/38,10	150"/38,10
200"/50,80	200"/50,80
300"/76,20	300"/76,20
400"/101,60	400"/101,60
	600"/152,40

P	9,525	P	12,70
H	1,91	H	2,29
H ₁	1,91	H ₁	2,29

Total Protection belt. The absence of tooth gap protects belt against corrosion.

T10 TP

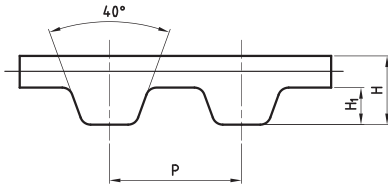

AT10 TP

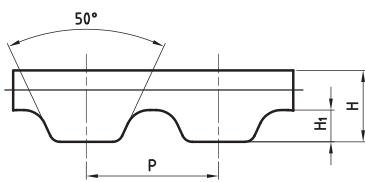

T10 TP	AT10 TP
Std. width (mm)	Std. width (mm)
10	-
16	16
25	25
32	32
50	50
75	75
100	100

P	10,00	P	10,00
H	4,50	H	4,50
H ₁	2,50	H ₁	2,50

HTD8M TP

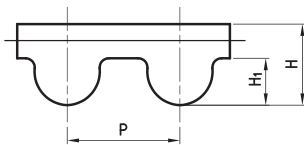

HTD8M TP
Std. width (mm)
10
15
20
30
50
85
100

P	8,00
H	5,60
H ₁	3,38

SAT 10

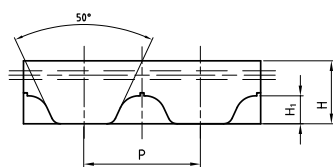

SAT 10
Std. width (mm)
50
75
100

P	10,00
H	4,50
H ₁	2,50

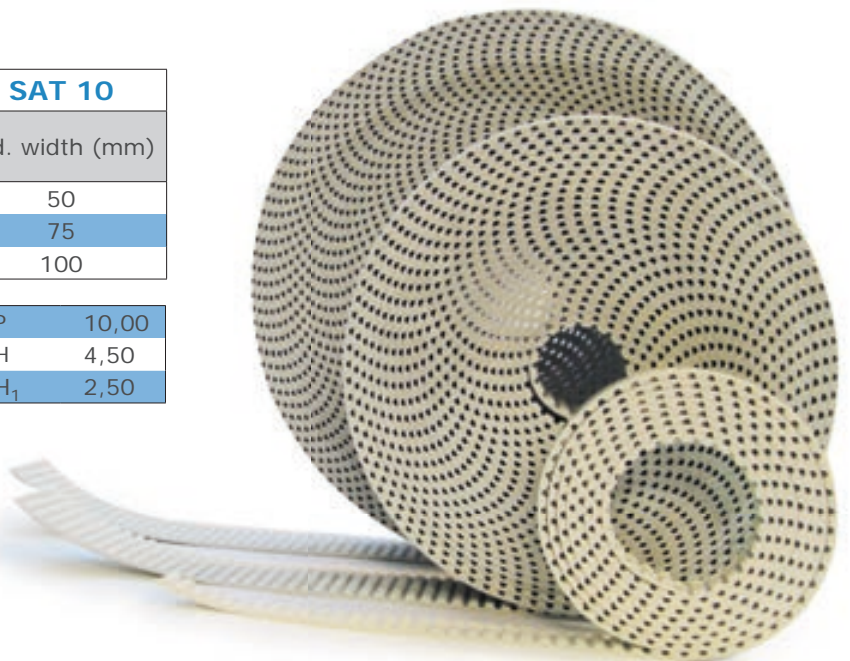

On request belts available with certificate FDA. Please contact our sales department.

Chiorino Polyurethane Open-end Timing Belts

Chiorino Extra-wide Polyurethane Belts extend the advantages of synchronous timing belts to wider surfaces and to the typical applications of flat and modular conveyor belts.

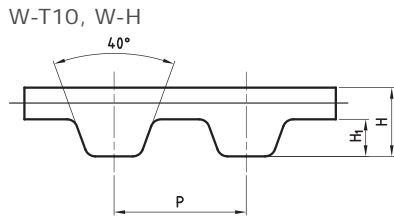

W-T10		W-H	
Std. width (mm)		Std. width (mm)	
200		8"/203,2	
250		10"/254,0	
300		12"/304,8	
350		14"/355,6	
400		16"/406,4	
450		18"/457,2	
500		20"/508,0	
P	10,00	P	12,70
H	4,50	H	4,29
H ₁	2,50	H ₁	2,29

Product overview

- Natural colour PU compound material 92 Sh A
- High durability
- Cut resistant
- Grease, chemicals and water resistant
- Non-marking
- Kevlar (Aramid) parallel cord reinforcement
- No cord exposure on belt edges
- Even cord tension
- Available in open end and welded execution
- Standard roll length 100 m

Available options

- FDA-compliant PU compound
- PAZ/PAR for noise reduction
- Tracking guides on teeth and/or back
- Silicon, PU, PVC and rubber backings
- Wide range of cleats, flights and profiles
- Perforation

Typical application

- Conveying, packaging
- Production of baby diapers and feminine hygiene items
- Car tires production



Chiorino-flex timing belts are **truly endless**. Due to the fact that no splices or welding are present the belt can be used in applications where a high load is being conveyed. They can be used **for power transmission and conveying with high loads and high speeds**.

The high tech manufacturing process allows a production of belts a wide range of length to permit flexibility in application.

The Chiorino-flex belts might be produced with special cords:

- CH - HPL** Chiorino high performance
- CH - HFE** Chiorino high flexibility
- CH - INOX** Chiorino stainless steel for high aggressive environment
- CH - ARAMID** Chiorino low weight, nonmagnetic

Chiorino-flex endless Timing Belts



T5 - T10 - T20

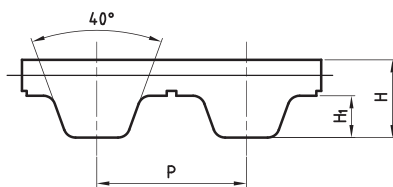

T5		T10		T20	
Std. width (mm)		Std. width (mm)		Std. width (mm)	
10		10		25	
16		16		32	
25		25		50	
32		32		75	
15		50		100	
75		75		150	
100		100			
150		150			

P	5,00	P	10,00	P	20,00
H	2,20	H	4,50	H	8,00
H ₁	1,20	H ₁	2,50	H ₁	5,00

Length range (mm)	Length range (mm)	Length range (mm)
900 – 15 225	900 – 19 500	900 – 19 820

AT5 - AT10 - AT20

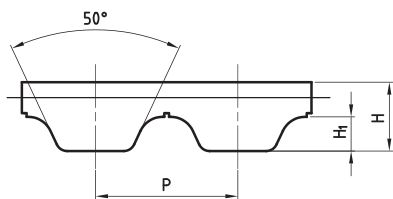

AT5		AT10		AT20		ATK10-K6	
Std. width (mm)		Std. width (mm)		Std. width (mm)		Std. width (mm)	
10		16		25		32	
16		25		32		50	
25		32		50		75	
32		50		75			
15		75		100			
75		100		150			
100		150					
150							

P	5,00	P	10,00	P	20,00	P	10,00
H	2,70	H	4,50	H	8,00	H	4,50
H ₁	1,20	H ₁	2,50	H ₁	5,00	H ₁	2,50

Length range (mm)	Length range (mm)	Length range (mm)	Length range (mm)
900 – 15 225	900 – 19 500	900 – 19 820	1 500 – 19 500

Chiorino-flex endless Timing Belts

ATP10

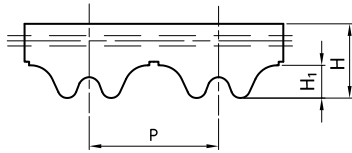

ATP10	
Std. width (mm)	
	16
	25
	32
	50
	75
	100
P	10,00
H	4,50
H ₁	2,50
Length range (mm)	
900 – 2 500	

HTD5M - HTD8M - HTD14M

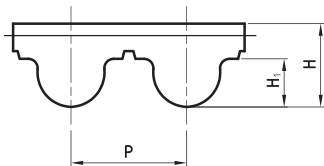

HTD5M	HTD8M	HTD14M			
Std. width (mm)					
10	10	40			
15	15	55			
25	20	85			
50	30	115			
100	50	150			
150	85				
	100				
	150				
P	5,00	P	8,00	P	14,00
H	3,70	H	5,60	H	10,00
H ₁	2,10	H ₁	3,38	H ₁	6,01
Length range (mm)		Length range (mm)		Length range (mm)	
900 – 15 650		900 – 19 536		1 500 – 19 348	

RTD5M - RTD8M - RTD14M

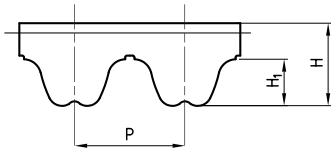

RTD5M	RTD8M	RTD14M			
Std. width (mm)					
10	10	40			
15	15	55			
25	20	85			
50	30	115			
100	50				
	85				
	100				
	150				
P	5,00	P	8,00	P	14,00
H	3,80	H	5,40	H	9,70
H ₁	2,05	H ₁	3,20	H ₁	5,85
Length range (mm)		Length range (mm)		Length range (mm)	
1 500 – 15 725		900 – 19 536		1 500 – 19 992	

The special profile allows smooth running properties. STD offers low noise in high speed drives.

XL - L - H - XH

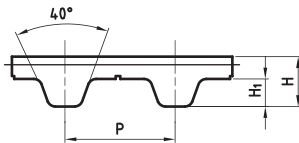

XL	L	H	XH
Std. width (inch)	Std. width (inch)	Std. width (inch)	Std. width (inch)
025	050	050	100
031	075	075	200
037	100	100	300
050	150	150	400
075	200	200	600
100	300	300	
150	400	400	
200			
400			

P	5,08	P	9,525	P	12,70	P	22,225
H	2,30	H	3,61	H	4,29	H	11,20
H ₁	1,27	H ₁	1,91	H ₁	2,29	H ₁	6,35

Length range (mm)	Length range (mm)	Length range (mm)	Length range (mm)
900 – 8 923	900 – 19 831	900 – 19 380	1 500 – 19 574

STD 5M - STD 8M - STD 14M

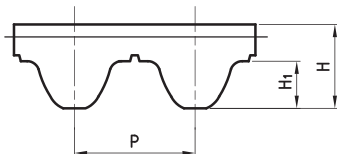

STD 5M	STD 8M	STD 14M
Std. width (mm)	Std. width (mm)	Std. width (mm)
10	10	40
15	15	55
25	20	85
50	30	115
100	50	150
	85	
	100	
	150	

P	5,00	P	8,00	P	14,00
H	3,35	H	5,30	H	10,20
H ₁	1,85	H ₁	3,05	H ₁	5,30

Length range (mm)	Length range (mm)	Length range (mm)
900 – 19 000	1 500 – 19 536	1 500 – 19 000

Chiorino-flex endless Timing Belts

Truly endless PU timing belts with helical offset tooth extremely reduces noise. Belt is self tracking and no need of pulley flanges.

EAGLE profile 5M - 8M - 10M - 14M

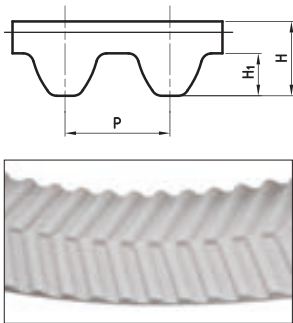

EAGLE 5M	EAGLE 8M	EAGLE 10M	EAGLE 14M
Std. width (mm)	Std. width (mm)	Std. width (mm)	Std. width (mm)
12,5	16	25	35
25	25	32	52,5
	32	50	70
	50		100

P	5,00	P	8,00	P	10,00	P	14,00
H	3,60	H	5,33	H	6,10	H	8,64
H ₁	1,91	H ₁	3,05	H ₁	3,90	H ₁	5,30

Length range (mm)	Length range (mm)	Length range (mm)	Length range (mm)
900 – 2 500	900 – 19 000	900 - 2 500	1 800 – 19 000

Polyurethane flat belts allows tense of small diameter pulleys. It is mainly used in drive applications where is no need for synchronization.

F2 - F2,5 - F3



F2	F2,5	F3
Std. width (mm)	Std. width (mm)	Std. width (mm)
25	25	25
32	30	30
50	60	60
75	100	100
100		

H	2,00	H	2,50	H	3,00
---	------	---	------	---	------

Length range (mm)	Length range (mm)	Length range (mm)
1 500 – 19 500	1 500 – 19 500	1 500 – 19 500

On demand it is possible to supply flex as double sided belts. Available DD pitches:

- T5, T10, T20, AT5, AT10, AT20
- L, H
- HTD 5M, HTD 8M, HTD 14M
- RTD 8M, RTD 14M
- STD 8M

Tooth profiles size are the same like in open DD.

On request belts available with certificate FDA. Please contact our sales department.

Idlers are frequently a mean to apply strain to the drive when the center distance is fixed but also to increase the number of teeth in mesh to the small pulley. A toothed idler on the inside of the belt on the loose side is recommended with respect to a back side idler. Drives with inside flat idlers are not recommended as noise and irregular belt wear may occur.

Flexibility

- Diameter for inside idler must be \geq of the diameter of the small pulley in the drive
- Idler should be positioned respecting: $2 \times (\text{small pulley diameter} + \text{large pulley diameter}) < \text{Center distance}$
- Idler must be installed on a stiff support
- Idlers width should be \geq of pulley width
- Idler position is on the loose side range of the belt drive

Minimum pulleys number of teeth and minimum idler diameter

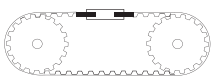
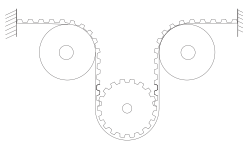
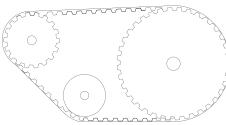
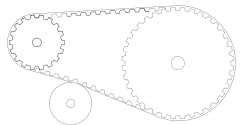
Type of belt		Drive without reverse bending		Drive with reverse bending		Drive without reverse bending		Drive with reverse bending	
									
Profile	Cords	Timing pulley Z_{min}	Flat idler min dia	Timing pulley Z_{min}	Flat idler on the belt back d_{min}	Timing pulley Z_{min}	Flat idler running on belt teeth d_{min}	Timing pulley Z_{min}	Flat idler running on the belt back d_{min}
T2,5	standard	14	18mm	14	22mm	10	15mm	18	15mm
T5	standard	10	30mm	15	30mm	10	30mm	15	30mm
	aramid	10	30mm	15	18mm				
	HPL	24	60 mm	38	60 mm				
DT5	standard					10	30mm	15	30mm
	aramid					10	18mm	12	18mm
T10	standard	12	60mm	20	60mm	12	60 mm	20	60mm
	aramid	15	60mm	20	60mm				
	stainless	15	60mm	40	60mm				
	HPL	15	100mm	30	100mm				
	HFE	10	50mm	15	50mm				
DT10	standard					12	60mm	20	60mm
	aramid					15	60mm	20	60mm
	stainless					12	60mm	20	60mm
	HFE					10	50mm	15	50mm
T10TP	standard	12	60mm	20	60mm				
T20	standard	15	120mm	25	120mm	15	120mm	25	120mm
	aramid	15	120mm	25	120mm				
	stainless	20	130mm	20	150mm				
	HFE	12	100mm	22	120mm				

Type of belt									
Profile	Cords	Timing pulley Z_{min}	Flat idler min dia	Timing pulley Z_{min}	Flat idler on the belt back d_{min}	Timing pulley Z_{min}	Flat idler running on belt teeth d_{min}	Timing pulley Z_{min}	Flat idler running on the belt back d_{min}
AT3	standard	15	20mm	20	20mm				
AT5	standard	15	30mm	25	60mm	15	30mm	25	60mm
	aramid	15	30mm	25	60mm				
	stainless	18	40mm	25	65mm				
	HFE	15	25mm	20	60mm				
ATL5	HPL	25	40mm	25	60mm				
AT10	standard	15	50mm	25	120mm	15	50mm	15	120mm
	aramid	15	50mm	20	120mm				
	stainless	20	70mm	40	120mm				
	HFE	12	50mm	20	80mm				
ATL10	HPE	25	80mm	25	150mm				
AT10TP	standard	15	50mm	25	120mm				
ATP10	steel					15	50mm	25	120mm
SFAT 10	steel	15	50mm	25	120mm				
	aramid	15	50mm	25	120mm				
	stainless	20	70mm	40	120mm				
	HFE	12	50mm	20	80mm				
AT20	standard	18	120mm	25	180mm	18	120mm	25	180mm
ATL20	standard	25	160mm	25	250mm				
TK5-K6	standard	25	60mm	25	80mm				
	aramid	25	60mm	25	80mm				
TK10-K6	standard	14	60 mm	20	60mm				
TK10-K13	standard	25	80mm	25	80mm				
	aramid	25	80mm	25	80mm				
ATK5-K6	standard	25	60mm	25	80mm				
	aramid	25	60mm	25	80mm				
ATK10-K13	standard	20	60mm	25	120mm				
	aramid	20	60mm	25	120mm				
ATK10-K6	standard					15	50mm	25	120mm
HTD3M	standard	20	30mm	25	60mm				
HTD5M	standard	16	30mm	25	60mm	16	50mm	25	60mm
	aramid	16	30mm	25	60mm				
	stainless	18	40mm	25	65mm				
HTD8M	standard	18	50mm	30	120mm	18	50mm	30	120mm
	aramid	18	50mm	30	120mm				
	stainless	24	70mm	40	100mm				
	HPL	30	80mm	30	150mm				
HTD8MTP	standard	18	50mm	18	120mm				
HTD14M	standard	28	120mm	28	180mm	28	120mm	28	180mm
HTD14XHPL	standard	34	140mm	34	200mm				
Eagle 5M	standard	16	30mm	25	60mm	16	30mm	25	60mm
Eagle 8M	standard	20	50mm	30	120mm	20	50mm	30	120mm
	stainless	24	70mm	40	120mm				
	HPL	30	80mm	30	150mm				
Eagle 10M	steel	25	80mm	25	150mm	25	80mm	25	150mm
Eagle 14M	standard	32	140mm	32	200mm	32	140mm	32	200mm
	HPL	32	140mm	32	200mm				

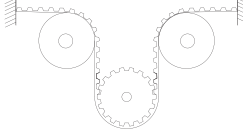
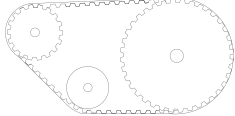
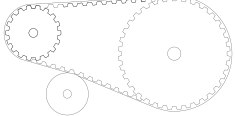
Type of belt									
Profile	Cords	Timing pulley Z_{min}	Flat idler min dia	Timing pulley Z_{min}	Flat idler on the belt back d_{min}	Timing pulley Z_{min}	Flat idler running on belt teeth d_{min}	Timing pulley Z_{min}	Flat idler running on the belt back d_{min}
STD5M	standard	16	30mm	25	60mm	16	30mm	25	60mm
	aramid	16	30mm	25	60mm				
	stainless	18	40mm	20	40mm				
	HFE	15	40mm	20	60mm				
STD8M	standard	18	50mm	30	120mm	18	50mm	30	120mm
	aramid	18	50mm	30	120mm				
	stainless	24	70mm	40	120mm				
	HPL	30	80mm	30	150mm				
STD14M	standard	32	140mm	32	250mm	26	120mm	28	180mm

RTD5M	standard	16	30mm	25	60mm	16	30mm	25	60mm
	aramid	16	30mm	25	60mm				
	stainless	18	40mm	25	65mm				
	HFE	15	25mm	20	60mm				
RTD8M	standard	18	50mm	30	120mm	18	50mm	18	120mm
	aramid	18	50mm	30	120mm				
	stainless	24	70mm	40	120mm				
	HPL	30	80mm	30	150mm				
RTD14M	standard	32	140mm	32	200mm	32	140mm	32	200mm
RTD14HPL	standard	34	140mm	32	200mm				
RTD14MXHPL	standard	34	140mm	34	200mm				

MXL	steel	12	20mm	15	25mm				
XL	standard	10	30mm	15	30mm	10	30mm	15	30mm
	aramid	10	30mm	15	30mm				
L	standard	15	60mm	20	60mm	15	60mm	20	60mm
	aramid	15	60mm	20	60mm				
	stainless	18	65mm	20	65mm				
H	standard	14	60mm	20	80mm	14	60mm	20	80mm
	aramid	14	60mm	20	80mm				
	stainless	20	80mm	40	100mm				
XH	standard	18	150mm	20	180mm	18	150mm	20	180mm
	aramid	18	150mm	20	180mm				
	stainless	24	160mm	30	200mm				

F1	standard		16mm		30mm		16mm		30mm
F2	standard		50mm		100mm		50mm		100mm
F2,5	standard		80mm		150mm		80mm		150mm
F3	standard		120mm		180mm		120mm		180mm
F8	steel		250mm		300mm				
F9	steel		250mm		300mm				

Chiorino Rubber Timing Belts are available in single or double sided teeth profile. They are characterized by a fiberglass reinforcement for minimal elongation and high flexibility. The Chloroprene Rubber wear and fabric tooth surface protection increases the service life of the timing belts.

Chiorino Rubber Timing Belts

MXL (Rubber)		
Type	Number of teeth z	Length [mm]
40 MXL	40	81,28
41 MXL	41	83,31
42 MXL	42	85,34
43 MXL	43	87,38
45 MXL	45	91,44
48 MXL	48	97,54
49 MXL	49	99,57
50 MXL	50	101,60
52 MXL	52	105,66
53 MXL	53	107,70
54 MXL	54	109,73
55 MXL	55	111,76
56 MXL	56	113,79
57 MXL	57	115,82
58 MXL	58	117,86
59 MXL	59	119,89
60 MXL	60	121,92
61 MXL	61	123,95
62 MXL	62	125,98
63 MXL	63	128,02
64 MXL	64	130,05
65 MXL	65	132,08
66 MXL	66	134,11
67 MXL	67	136,14
68 MXL	68	138,18
69 MXL	69	140,21
70 MXL	70	142,24
71 MXL	71	144,27
72 MXL	72	146,30
73 MXL	73	148,34
74 MXL	74	150,37
75 MXL	75	152,40
76 MXL	76	154,43
77 MXL	77	156,46
78 MXL	78	158,50
79 MXL	79	160,53
80 MXL	80	162,56
82 MXL	82	166,62

MXL (Rubber)		
Type	Number of teeth z	Length [mm]
83 MXL	83	168,66
84 MXL	84	170,69
85 MXL	85	172,72
86 MXL	86	174,75
87 MXL	87	176,78
88 MXL	88	178,82
89 MXL	89	180,85
90 MXL	90	182,88
91 MXL	91	184,91
92 MXL	92	186,94
93 MXL	93	188,98
94 MXL	94	191,01
95 MXL	95	193,04
96 MXL	96	195,07
97 MXL	97	197,10
98 MXL	98	199,14
100 MXL	100	203,20
101 MXL	101	205,23
102 MXL	102	207,26
103 MXL	103	209,30
104 MXL	104	211,33
105 MXL	105	213,36
106 MXL	106	215,39
107 MXL	107	217,42
108 MXL	108	219,46
109 MXL	109	221,49
110 MXL	110	223,52
111 MXL	111	225,55
112 MXL	112	227,58
113 MXL	113	229,62
114 MXL	114	231,65
115 MXL	115	233,68
116 MXL	116	235,71
118 MXL	118	239,78
119 MXL	119	241,81
120 MXL	120	243,84
121 MXL	121	245,87
122 MXL	122	247,90
123 MXL	123	249,94
124 MXL	124	251,97
125 MXL	125	254,00
126 MXL	126	256,03
127 MXL	127	258,06
128 MXL	128	260,10

MXL (Rubber)		
Type	Number of teeth z	Length [mm]
129 MXL	129	262,13
130 MXL	130	264,16
131 MXL	131	266,19
132 MXL	132	268,22
133 MXL	133	270,26
134 MXL	134	272,29
135 MXL	135	274,32
136 MXL	136	276,35
138 MXL	138	280,42
139 MXL	139	282,45
140 MXL	140	284,48
142 MXL	142	288,54
143 MXL	143	290,58
144 MXL	144	292,61
145 MXL	145	294,64
147 MXL	147	298,70
148 MXL	148	300,74
149 MXL	149	302,77
150 MXL	150	304,80
151 MXL	151	306,83
152 MXL	152	308,86
155 MXL	155	314,96
156 MXL	156	316,99
157 MXL	157	319,02
158 MXL	158	321,06
159 MXL	159	323,09
160 MXL	160	325,12
162 MXL	162	329,18
163 MXL	163	331,22
164 MXL	164	333,25
165 MXL	165	335,28
166 MXL	166	337,31
168 MXL	168	341,38
170 MXL	170	345,44



MXL (Rubber)		
Type	Number of teeth z	Length [mm]
171 MXL	171	347,47
175 MXL	175	355,60
177 MXL	177	359,66
180 MXL	180	365,76
183 MXL	183	371,86
184 MXL	184	373,89
187 MXL	187	379,98
188 MXL	188	382,02
190 MXL	190	386,08
194 MXL	194	394,21
195 MXL	195	396,24
198 MXL	198	402,34
200 MXL	200	406,40
202 MXL	202	410,46
203 MXL	203	412,50
208 MXL	208	422,66
210 MXL	210	426,72
212 MXL	212	430,78
215 MXL	215	436,88
216 MXL	216	438,91
221 MXL	221	449,07
222 MXL	222	451,10
227 MXL	227	461,26
228 MXL	228	463,30
229 MXL	229	465,33
230 MXL	230	467,36
232 MXL	232	471,42
236 MXL	236	479,55
237 MXL	237	481,58
238 MXL	238	483,62
239 MXL	239	485,65
240 MXL	240	487,68
243 MXL	243	493,78
245 MXL	245	497,84
248 MXL	248	503,94
250 MXL	250	508,00
251 MXL	251	510,03
255 MXL	255	518,16
256 MXL	256	520,19
263 MXL	263	534,42
265 MXL	265	538,48
270 MXL	270	548,64
276 MXL	276	560,83
280 MXL	280	568,96
283 MXL	283	575,06
285 MXL	285	579,12
290 MXL	290	589,28
292 MXL	292	593,34
295 MXL	295	599,44
297 MXL	297	603,50
298 MXL	298	605,54
300 MXL	300	609,60

MXL (Rubber)		
Type	Number of teeth z	Length [mm]
305 MXL	305	619,76
309 MXL	309	627,89
310 MXL	310	629,92
315 MXL	315	640,08
320 MXL	320	650,24
323 MXL	323	656,34
324 MXL	324	658,37
328 MXL	328	666,50
330 MXL	330	670,56
334 MXL	334	678,69
340 MXL	340	690,88
347 MXL	347	705,10
350 MXL	350	711,20
358 MXL	358	727,46
360 MXL	360	731,52
363 MXL	363	737,62
365 MXL	365	741,68
371 MXL	371	753,87
372 MXL	372	755,90
378 MXL	378	768,10
380 MXL	380	772,16
388 MXL	388	788,42
390 MXL	390	792,48
397 MXL	397	806,70
400 MXL	400	812,80
405 MXL	405	822,96
408 MXL	408	829,06
412 MXL	412	837,18
424 MXL	424	861,57
427 MXL	427	867,66
434 MXL	434	881,89
453 MXL	453	920,50
460 MXL	460	934,72
463 MXL	463	940,82
464 MXL	464	942,85
468 MXL	468	950,98
472 MXL	472	959,10
475 MXL	475	965,20
478 MXL	478	971,30
482 MXL	482	979,42
487 MXL	487	989,58
505 MXL	505	1026,16
531 MXL	531	1078,99
540 MXL	540	1097,28
541 MXL	541	1099,31
544 MXL	544	1105,41
546 MXL	546	1109,47
549 MXL	549	1115,57
550 MXL	550	1117,60
556 MXL	556	1129,79
557 MXL	557	1131,82
558 MXL	558	1133,86

MXL (Rubber)		
Type	Number of teeth z	Length [mm]
559 MXL	559	1135,89
562 MXL	562	1141,98
563 MXL	563	1144,02
566 MXL	566	1150,11
568 MXL	568	1154,18
570 MXL	570	1158,24
573 MXL	573	1164,34
578 MXL	578	1174,50
580 MXL	580	1178,56
583 MXL	583	1184,66
592 MXL	592	1202,94
605 MXL	605	1229,36
612 MXL	612	1243,58
648 MXL	648	1316,74
652 MXL	652	1324,86
680 MXL	680	1381,76
705 MXL	705	1432,56
726 MXL	726	1475,23
762 MXL	762	1548,38
776 MXL	776	1576,83
805 MXL	805	1635,76
875 MXL	875	1778,00
906 MXL	906	1840,99
930 MXL	930	1889,76
1076 MXL	1076	2186,43
1078 MXL	1078	2190,50
1166 MXL	1166	2369,31
1380 MXL	1380	2804,16
1392 MXL	1392	2828,54
1778 MXL	1778	3612,90
1806 MXL	1806	3669,79
2044 MXL	2044	4153,41



Chiorino Rubber Timing Belts

XL (Rubber)

Type	Number of teeth z	Length [mm]
46 XL	23	116,84
48 XL	24	121,92
50 XL	25	127,00
56 XL	28	142,24
60 XL	30	152,40
64 XL	32	162,56
66 XL	33	167,64
68 XL	34	172,72
70 XL	35	177,80
72 XL	36	182,88
74 XL	37	187,96
76 XL	38	193,04
78 XL	39	198,12
80 XL	40	203,20
82 XL	41	208,28
84 XL	42	213,36
86 XL	43	218,44
88 XL	44	223,52
90 XL	45	228,60
92 XL	46	233,68
94 XL	47	238,76
96 XL	48	243,84
98 XL	49	248,92
100 XL	50	254,00
102 XL	51	259,08
104 XL	52	264,16
106 XL	53	269,24
108 XL	54	274,32
110 XL	55	279,40
112 XL	56	284,48
114 XL	57	289,56
116 XL	58	294,64
118 XL	59	299,72
120 XL	60	304,80
122 XL	61	309,88
124 XL	62	314,96
126 XL	63	320,04
128 XL	64	325,12
130 XL	65	330,20
132 XL	66	335,28
134 XL	67	340,36
136 XL	68	345,44
138 XL	69	350,52
140 XL	70	355,60
142 XL	71	360,68
144 XL	72	365,76

XL (Rubber)

Type	Number of teeth z	Length [mm]
146 XL	73	370,84
148 XL	74	375,92
150 XL	75	381,00
152 XL	76	386,08
154 XL	77	391,16
156 XL	78	396,24
158 XL	79	401,32
160 XL	80	406,40
162 XL	81	411,48
164 XL	82	416,56
166 XL	83	421,64
168 XL	84	426,72
170 XL	85	431,80
172 XL	86	436,88
174 XL	87	441,96
176 XL	88	447,04
178 XL	89	452,12
180 XL	90	457,20
182 XL	91	462,28
184 XL	92	467,36
186 XL	93	472,44
188 XL	94	477,52
190 XL	95	482,60
192 XL	96	487,68
194 XL	97	492,76
196 XL	98	497,84
198 XL	99	502,92
200 XL	100	508,00
202 XL	101	513,08
204 XL	102	518,16
206 XL	103	523,24
208 XL	104	528,32
210 XL	105	533,40
212 XL	106	538,48
214 XL	107	543,56
216 XL	108	548,64
218 XL	109	553,72
220 XL	110	558,80
222 XL	111	563,88
224 XL	112	568,96
228 XL	114	579,12
230 XL	115	584,20
234 XL	117	594,36
238 XL	119	604,52
240 XL	120	609,60
244 XL	122	619,76
250 XL	125	635,00
252 XL	126	640,08
254 XL	127	645,16
256 XL	128	650,24
260 XL	130	660,40
262 XL	131	665,48

XL (Rubber)

Type	Number of teeth z	Length [mm]
268 XL	134	680,72
270 XL	135	685,80
274 XL	137	695,96
276 XL	138	701,04
278 XL	139	706,12
280 XL	140	711,20
282 XL	141	716,28
286 XL	143	726,44
288 XL	144	731,52
290 XL	145	736,60
296 XL	148	751,84
300 XL	150	762,00
304 XL	152	772,16
306 XL	153	777,24
310 XL	155	787,40
312 XL	156	792,48
314 XL	157	797,56
316 XL	158	802,64
320 XL	160	812,80
322 XL	161	817,88
326 XL	163	828,04
330 XL	165	838,20
340 XL	170	863,60
344 XL	172	873,76
348 XL	174	883,92
350 XL	175	889,00
352 XL	176	894,08
356 XL	178	904,24
360 XL	180	914,40
362 XL	181	919,48
364 XL	182	924,56
370 XL	185	939,80
376 XL	188	955,04
380 XL	190	965,20
384 XL	192	975,36
388 XL	194	985,52
390 XL	195	990,60
392 XL	196	995,68
396 XL	198	1005,84
400 XL	200	1016,00
408 XL	204	1036,32
412 XL	206	1046,48
414 XL	207	1051,56
420 XL	210	1066,80
424 XL	212	1076,96
430 XL	215	1092,20
432 XL	216	1097,28
450 XL	225	1143,00
464 XL	232	1178,56
478 XL	239	1214,12
480 XL	240	1219,20
490 XL	245	1244,60

XL (Rubber)

Type	Number of teeth z	Length [mm]
492 XL	246	1249,68
514 XL	257	1305,56
522 XL	261	1325,88
532 XL	266	1351,28
540 XL	270	1371,60
552 XL	276	1402,08
564 XL	282	1432,56
566 XL	283	1437,64
570 XL	285	1447,80
572 XL	286	1452,88
574 XL	287	1457,96
576 XL	288	1463,04
580 XL	290	1473,20
592 XL	296	1503,68
600 XL	300	1524,00
612 XL	306	1554,48
616 XL	308	1564,64
620 XL	310	1574,80
630 XL	315	1600,20
660 XL	330	1676,40
670 XL	335	1701,80
700 XL	350	1778,00
720 XL	360	1828,80
754 XL	377	1915,16
828 XL	414	2103,12
860 XL	430	2184,40
900 XL	450	2286,00
926 XL	463	2352,04
980 XL	490	2489,20
1014 XL	507	2575,56
1066 XL	533	2707,64
1300 XL	650	3302,00
1552 XL	776	3942,08

Started from 150XL it is possible to supply as double sided belts. Please ask about MOQ.



L (Rubber)

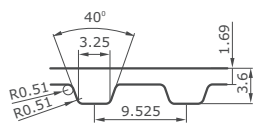

Type	Number of teeth z	Length [mm]
98L	26	247,65
109L	29	276,23
112L	30	285,75
124L	33	314,33
131L	35	333,38
135L	36	342,90
143L	38	361,95
150L	40	381,00
154L	41	390,53
157L	42	400,05
160L	43	409,58
165L	44	419,10
169L	45	428,63
173L	46	438,15
178L	47	447,68
180L	48	457,20
182L	49	466,73
185 L	49	466,73
187L	50	476,25
191L	51	485,78
195L	52	495,30
200L	53	504,83
203L	54	514,35
210L	56	533,40
214L	57	542,93
217L	58	552,45
220L	59	561,98
225L	60	571,50
232L	62	590,55
236L	63	600,08
240L	64	609,60
244L	65	619,13
248L	66	628,65
251L	67	638,18
255L	68	647,70
263L	70	666,75
265L	71	676,28
270L	72	685,80
275L	73	695,33
277L	74	704,85
280L	75	714,38
285L	76	723,90
292L	78	742,95
300L	80	762,00
304L	81	771,53
310L	83	790,58
315L	84	800,10

L (Rubber)

Type	Number of teeth z	Length [mm]
320L	85	809,63
322L	86	819,15
330L	88	838,20
334L	89	847,73
337L	90	857,25
341L	91	866,78
345L	92	876,30
352L	94	895,35
360L	96	914,40
367L	98	933,45
375L	100	952,50
378L	101	960,12
382L	102	971,55
387L	103	982,98
390L	104	990,60
394L	105	1 000,13
398L	106	1 009,65
405L	108	1 028,70
412L	110	1 047,75
420L	112	1 066,80
427L	114	1 085,85
435L	116	1 104,90
439L	117	1 114,43
450L	120	1 143,00
453L	121	1 152,53
457L	122	1 162,05
461L	123	1 171,58
465L	124	1 181,10
472L	126	1 200,15
480L	128	1 219,20
495L	132	1 257,30
500L	133	1 266,83
510L	136	1 295,40
514L	137	1 304,93
525L	140	1 333,50
540L	144	1 371,60
548L	146	1 390,65
550L	147	1400,17
555L	148	1409,70
570L	152	1 447,80
581L	155	1 476,38
600L	160	1 524,00
630L	168	1 600,20
653L	174	1 657,35
660L	176	1 676,40
675L	180	1 714,50
694L	185	1 762,13
697L	186	1 771,65
700L	187	1 781,18
720L	192	1828,80
728L	194	1 847,85
731L	195	1 857,38

L (Rubber)

Type	Number of teeth z	Length [mm]
739L	197	1 876,43
750L	200	1 905,00
765L	204	1 943,10
780L	208	1981,20
788L	210	2000,25
795L	212	2019,30
817L	218	2 076,45
866L	231	2200,27
870L	232	2209,80
900L	240	2 286,00
915L	244	2324,10
934L	249	2371,73
982L	262	2494,28
1275L	340	3238,50
2093L	558	5314,95

Started from 160L it is possible to supply as double sided belts. Please ask about MOQ.



Chiorino Rubber Timing Belts

H (Rubber)

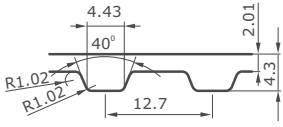

Type	Number of teeth z	Length [mm]
160 H	32	406,40
185 H	37	469,90
200 H	40	508,00
205 H	41	520,70
210 H	42	533,40
215 H	43	546,10
220 H	44	558,80
225 H	45	571,50
230 H	46	584,20
235 H	47	596,90
240 H	48	609,60
245 H	49	622,30
250 H	50	635,00
255 H	51	647,70
260 H	52	660,40
265 H	53	673,10
270 H	54	685,80
275 H	55	698,50
280 H	56	711,20
285 H	57	723,90
290 H	58	736,60
300 H	60	762,00
305 H	61	774,70
310 H	62	787,40
315 H	63	800,10
320 H	64	812,80
330 H	66	838,20
335 H	67	850,90
340 H	68	863,60
345 H	69	876,30
350 H	70	889,00
355 H	71	901,70
360 H	72	914,40
365 H	73	927,10
370 H	74	939,80
375 H	75	952,50
380 H	76	965,20
385 H	77	977,90
390 H	78	990,60
395 H	79	1003,30
400 H	80	1016,00
405 H	81	1028,70
410 H	82	1041,40
415 H	83	1054,10
420 H	84	1066,80
425 H	85	1079,50
430 H	86z	1092,20

H (Rubber)

Type	Number of teeth z	Length [mm]
440 H	88	1117,60
445 H	89	1130,30
450 H	90	1143,00
455 H	91	1155,70
460 H	92	1168,40
465 H	93	1181,10
470 H	94	1193,80
480 H	96	1219,20
485 H	97	1231,90
490 H	98	1244,60
500 H	100	1270,00
510 H	102	1295,40
515 H	103	1308,10
520 H	104	1320,80
525 H	105	1333,50
530 H	106	1346,20
535 H	107	1358,90
540 H	108	1371,60
550 H	110	1397,00
560 H	112	1422,40
570 H	114	1447,80
575 H	115	1460,50
580 H	116	1473,20
585 H	117	1485,90
590 H	118	1498,60
600 H	120	1524,00
605 H	121	1536,70
610 H	122	1549,40
615 H	123	1562,10
625 H	125	1587,50
630 H	126	1600,20
640 H	128	1625,60
645 H	129	1638,30
650 H	130	1651,00
660 H	132	1676,40
670 H	134	1701,80
680 H	136	1727,20
700 H	140	1778,00
710 H	142	1803,40
720 H	144	1828,80
725 H	145	1841,50
730 H	146	1854,20
740 H	148	1879,60
750 H	150	1905,00
770 H	154	1955,80
780 H	156	1981,20
785 H	157	1993,90
800 H	160	2032,00
810 H	162	2057,40
820 H	164	2082,80
830 H	166	2108,20
840 H	168	2133,60

H (Rubber)

Type	Number of teeth z	Length [mm]
850 H	170	2159,00
860 H	172	2184,40
880 H	176	2235,20
900 H	180	2286,00
950 H	190	2413,00
960 H	192	2438,40
980 H	196	2489,20
985 H	197	2501,50
1000 H	200	2540,00
1020 H	204	2590,80
1050 H	210	2667,00
1070 H	214	2717,80
1100 H	220	2794,00
1120 H	224	2844,80
1140 H	228	2895,60
1150 H	230	2921,00
1160 H	232	2946,40
1170 H	234	2971,80
1175 H	235	2984,50
1180 H	236	2997,20
1200 H	240	3048,00
1250 H	250	3175,00
1285 H	257	3263,90
1300 H	260	3302,00
1325 H	265	3365,50
1350 H	270	3429,00
1360 H	272	3454,40
1375 H	275	3492,50
1390 H	278	3530,60
1400 H	280	3556,00
1450 H	290	3683,00
1540 H	308	3911,60
1600 H	320	4064,00
1630 H	326	4140,20
1680 H	336	4267,20
1700 H	340	4318,00
1800 H	360	4572,00
2000 H	400	5080,00
2010 H	402	5105,40
2100 H	420	5334,00

XH (Rubber)

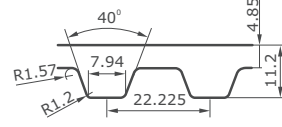

Type	Number of teeth z	Length [mm]
420 XH	48	1066,80
507 XH	58	1287,78
560 XH	64	1422,40
570 XH	65	1447,80
630 XH	72	1600,20
700 XH	80	1778,00
726 XH	83	1844,04
735 XH	84	1866,90
753 XH	86	1910,08
761 XH	87	1932,94
770 XH	88	1955,80
796 XH	91	2021,84
840 XH	96	2133,60
927 XH	106	2354,58
980 XH	112	2489,20
1120 XH	128	2844,80
1260 XH	144	3200,40
1400 XH	160	3556,00
1540 XH	176	3911,60
1750 XH	200	4445,00

Type H available also as double sided belts. Please ask about MOQ.



T2,5 (Rubber)

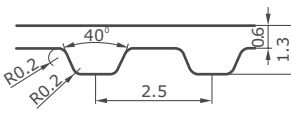

Number of teeth z	Length [mm]
58	145
60	150
62	155
63	157,5
64	160
65	162,5
69	172,5
71	177,5
74	185
78	195
87	217,5
90	225
92	230
98	245
106	265
116	290
132	330
152	380
140	350
260	650
332	830
428	1070
800	2000

T5 (Rubber)

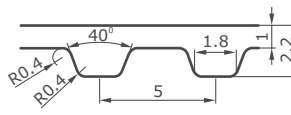

Number of teeth z	Length [mm]
37	185
38	190
40	200
42	210
43	215
48	240
49	245
50	250
51	255
54	270
55	275
56	280
60	300
71	355
78	390
82	410
84	420
89	445
90	450
91	455
92	460
95	475
98	490
100	500
102	510
105	525
110	550
112	560
122	610
132	660
145	725
150	750
156	780
162	810
168	840
180	900
198	990
209	1045
215	1075
220	1100
230	1150
243	1215
276	1380
456	2280

T10 (Rubber)

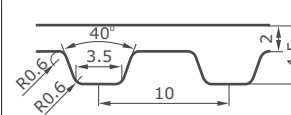

Number of teeth z	Length [mm]
36	360
38	380
40	400
44	440
48	480
49	490
50	500
51	510
53	530
56	560
60	600
63	630
66	660
70	700
72	720
73	730
78	780
81	810
84	840
91	910
92	920
98	980
100	1000

T10 (Rubber)

Number of teeth z	Length [mm]
101	1010
108	1080
110	1100
111	1110
115	1150
121	1210
128	1280
130	1300
132	1320
135	1350
139	1390
142	1420
146	1460
149	1490
154	1540
156	1560
161	1610
163	1630
175	1750
178	1780
180	1800
188	1880
196	1960
225	2250

T5 available as double sided belts from length 355 mm.
T10 available as double sided belts from length 440 mm.
Please ask about MOQ.



Chiorino Rubber Timing Belts

HTD 3M (Rubber)

Number of teeth z	Length [mm]
35	105
37	111
38	114
39	117
40	120
41	123
42	126
43	129
44	132
45	135
46	138
47	141
48	144
49	147
50	150
51	153
52	156
53	159
54	162
55	165
56	168
57	171
58	174
59	177
60	180
61	183
62	186
63	189
64	192
65	195
66	198
67	201
68	204
69	207
70	210
71	213
72	216
73	219
74	222
75	225
76	228
77	231
78	234
79	237
80	240
81	243
82	246
83	249
84	252
85	255
86	258
87	261
88	264
89	267

HTD 3M (Rubber)

Number of teeth z	Length [mm]
90	270
91	273
92	276
93	279
94	282
95	285
96	288
97	291
98	294
99	297
100	300
101	303
102	306
103	309
104	312
105	315
106	318
107	321
108	324
109	327
110	330
111	333
112	336
113	339
114	342
115	345
116	348
117	351
118	354
119	357
120	360
121	363
122	366
123	369
124	372
125	375
126	378
127	381
128	384
129	387
130	390
131	393
132	396
133	399
134	402
135	405
137	411
139	417
140	420
141	423
142	426
144	432
145	435
146	438
147	441
148	444
149	447
150	450
151	453
152	456

HTD 3M (Rubber)

Number of teeth z	Length [mm]
153	459
154	462
155	465
156	468
158	474
159	477
160	480
161	483
162	486
163	489
164	492
165	495
166	498
167	501
168	504
169	507
170	510
171	513
173	519
174	522
175	525
177	531
178	534
179	537
180	540
183	549
184	552
187	561
188	564
190	570
191	573
192	576
193	579
194	582
195	585
196	588
197	591
198	594
199	597
200	600
201	603
202	606
203	609
204	612
209	627
210	630
211	633
212	636
215	645
216	648
219	657
220	660
221	663
223	669
224	672
225	675
228	684
229	687
232	696
236	708

HTD 3M (Rubber)

Number of teeth z	Length [mm]
237	711
239	717
244	732
245	735
246	738
251	753
252	756
256	768
268	804
270	810
271	813
281	843
286	858
295	885
300	900
303	909
307	921
312	936
320	960
322	966
338	1014
350	1050
354	1062
357	1071
375	1125
415	1245
421	1263
448	1344
488	1464
510	1530
523	1569
560	1680
600	1800
621	1863
651	1953
796	2388
1100	3300

HTD 5M (Rubber)	
Number of teeth z	Length [mm]
24	120
30	150
36	180
39	195
43	215
45	225
46	230
47	235
48	240
49	245
50	250
51	255
52	260
53	265
54	270
55	275
56	280
57	285
59	295
60	300
61	305
62	310
63	315
64	320
65	325
66	330
68	340
69	345
70	350
71	355
72	360
73	365
74	370
75	375
77	385
78	390
80	400
81	405
82	410
83	415
84	420
85	425
86	430
87	435
88	440
90	450
91	455
92	460
93	465
94	470
95	475
96	480

HTD 5M (Rubber)	
Number of teeth z	Length [mm]
98	490
99	495
100	500
102	510
103	515
104	520
105	525
106	530
107	535
108	540
110	550
112	560
113	565
114	570
115	575
116	580
117	585
118	590
119	595
120	600
122	610
123	615
124	620
125	625
126	630
127	635
128	640
129	645
130	650
132	660
133	665
134	670
135	675
136	680
138	690
139	695
140	700
141	705
142	710
144	720
145	725
146	730
148	740
149	745
150	750
151	755
153	765
154	770
155	775
156	780
157	785
158	790
160	800
162	810
163	815
164	820
165	825
166	830

HTD 5M (Rubber)	
Number of teeth z	Length [mm]
167	835
168	840
169	845
170	850
172	860
174	870
176	880
178	890
180	900
182	910
184	920
185	925
186	930
187	935
188	940
189	945
190	950
192	960
193	965
195	975
196	980
198	990
200	1000
205	1025
207	1035
210	1050
216	1080
220	1100
223	1115
224	1120
225	1125
227	1135
228	1140
229	1145
230	1150
235	1175
239	1195
240	1200
242	1210
245	1225
247	1235
248	1240
250	1250
254	1270
255	1275
260	1300
270	1350
280	1400
284	1420
298	1490
300	1500
306	1530
308	1540
315	1575
318	1590
319	1595
323	1615
337	1685

HTD 5M (Rubber)	
Number of teeth z	Length [mm]
338	1690
340	1700
346	1730
358	1790
360	1800
370	1850
374	1870
379	1895
380	1900
383	1915
388	1940
389	1945
400	2000
410	2050
412	2060
420	2100
450	2250
470	2350
505	2525
582	2910
640	3200
760	3800
1060	5300

Started from length 350 mm available as double sided belts. Please ask about MOQ.



Chiorino Rubber Timing Belts

HTD 8M (Rubber)

Number of teeth z	Length [mm]
23	184
31	248
40	320
41	328
43	344
44	352
46	368
47	376
50	400
51	408
52	416
53	424
55	440
56	448
57	456
60	480
62	496
64	512
65	520
66	528
67	536
68	544
70	560
71	568
72	576
73	584
75	600
76	608
78	624
79	632
80	640
82	656
83	664
84	672
85	680
86	688
87	696
89	712
90	720
91	728
92	736
93	744
95	760
97	776
98	784
100	800
102	816
103	824
104	832
105	840

HTD 8M (Rubber)

Number of teeth z	Length [mm]
106	848
107	856
108	864
109	872
110	880
111	888
112	896
113	904
114	912
115	920
116	928
117	936
118	944
119	952
120	960
121	968
122	976
123	984
125	1000
126	1008
127	1016
128	1024
129	1032
130	1040
132	1056
133	1064
134	1072
135	1080
136	1088
137	1096
138	1104
139	1112
140	1120
141	1128
142	1136
143	1144
144	1152
145	1160
146	1168
147	1176
148	1184
149	1192
150	1200
152	1216
153	1224
155	1240
156	1248
157	1256
158	1264
159	1272
160	1280
162	1296
163	1304
164	1312
165	1320
166	1328

HTD 8M (Rubber)

Number of teeth z	Length [mm]
168	1344
169	1352
170	1360
173	1384
174	1392
175	1400
176	1408
177	1416
178	1424
179	1432
180	1440
182	1456
183	1464
185	1480
187	1496
188	1504
189	1512
190	1520
192	1536
193	1544
194	1552
195	1560
197	1576
198	1584
200	1600
201	1608
203	1624
204	1632
205	1640
206	1648
210	1680
212	1696
213	1704
215	1720
216	1728
218	1744
220	1760
222	1776
223	1784
224	1792
225	1800
226	1808
228	1824
230	1840
232	1856
233	1864
235	1880
236	1888
237	1896
238	1904
239	1912
240	1920
242	1936
243	1944
244	1952
245	1960

HTD 8M (Rubber)

Number of teeth z	Length [mm]
248	1984
250	2000
254	2032
255	2040
257	2056
260	2080
263	2104
265	2120
270	2160
273	2184
275	2200
278	2224
280	2240
281	2248
282	2256
284	2272
285	2280
288	2304
289	2312
290	2320
294	2352
295	2360
300	2400
304	2432
305	2440
310	2480
312	2496
313	2504
315	2520
317	2536
325	2600
330	2640
336	2688
350	2800
354	2832
360	2880
365	2920
381	3048
385	3080
390	3120
400	3200
402	3216
410	3280
420	3360
423	3384
425	3400
450	3600
478	3824
550	4400
612	4896

Started from length 350 mm available as double sided belts. Please ask about MOQ.

HTD 14M (Rubber)

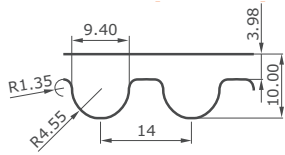

Number of teeth z	Length [mm]
59	826
60	840
64	896
66	924
69	966
72	1008
74	1036
75	1050
76	1064
78	1092
80	1120
82	1148
84	1176
85	1190
89	1246
90	1260
92	1288
94	1316
96	1344
97	1358
100	1400
101	1414
102	1428
103	1442
104	1456
105	1470
106	1484
108	1512
110	1540
112	1568
115	1610
117	1638
118	1652
119	1666
120	1680
124	1736
125	1750
126	1764
127	1778
128	1792
129	1806
130	1820
132	1848
133	1862
135	1890
136	1904
138	1932
139	1946

HTD 14M (Rubber)

Number of teeth z	Length [mm]
140	1960
143	2002
146	2044
148	2072
150	2100
154	2156
155	2170
158	2212
160	2240
165	2310
170	2380
175	2450
185	2590
186	2604
190	2660
197	2758
200	2800
208	2912
210	2940
225	3150
240	3360
244	3416
250	3500
275	3850
286	4004
309	4326
327	4578
340	4760
354	4956

Started from length 966 mm available as double sided belts. Please ask about MOQ.

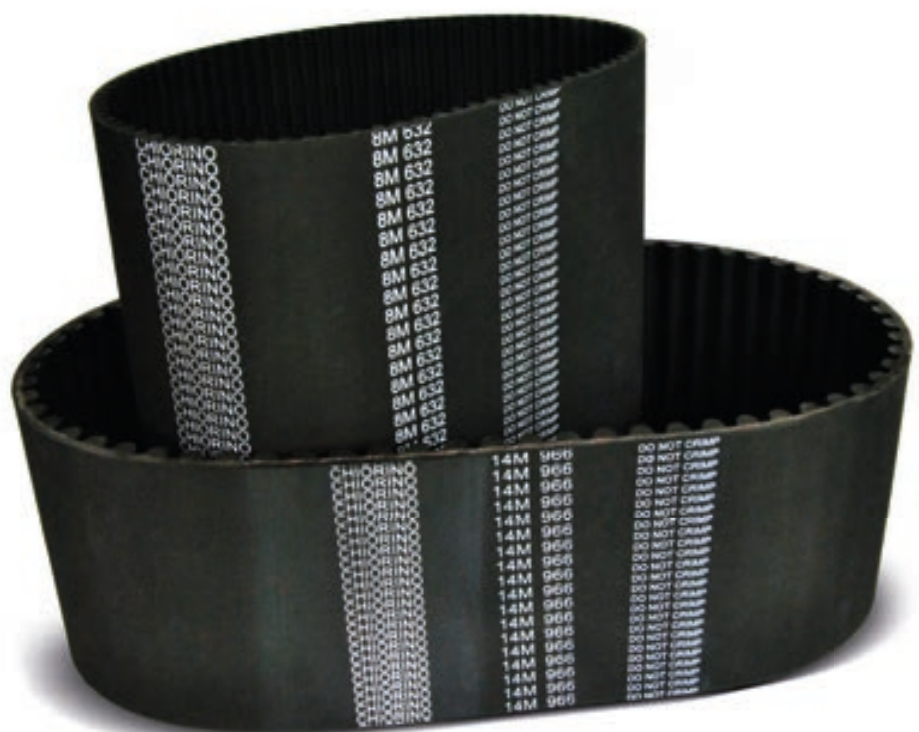

Chiorino Rubber Timing Belts

STD 3M (Rubber)

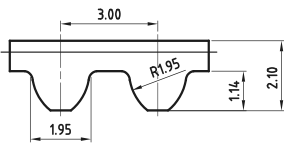

Number of teeth z	Length [mm]
38	114
40	120
42	126
43	129
46	138
47	141
49	147
50	150
54	162
58	174
59	177
60	180
61	183
62	186
63	189
64	192
65	195
67	201
68	204
69	207
70	210
72	216
73	219
74	222
75	225
77	231
78	234
79	237
80	240
81	243
82	246
84	252
85	255
86	258
87	261
88	264
89	267
90	270
91	273
92	276
94	282
95	285
96	288
98	294
100	300
103	309

STD 3M (Rubber)

Number of teeth z	Length [mm]
104	312
105	315
106	318
107	321
108	324
109	327
111	333
112	336
113	339
115	345
117	351
118	354
120	360
121	363
122	366
125	375
128	384
132	396
133	399
139	417
140	420
141	423
145	435
149	447
151	453
154	462
156	468
157	471
158	474
159	477
160	480
161	483
162	486
163	489
165	495
166	498
167	501
170	510
171	513
172	516
173	519
175	525
178	534
179	537
180	540
182	546
183	549
184	552
185	555
186	558
187	561
188	564

STD 3M (Rubber)

Number of teeth z	Length [mm]
190	570
191	573
193	579
194	582
195	585
196	588
197	591
198	594
199	597
200	600
201	603
202	606
203	609
207	621
211	633
212	636
215	645
219	657
220	660
222	666
230	690
235	705
237	711
238	714
246	738
250	750
251	753
255	765
260	780
268	804
273	819
276	828
294	882
396	1188
407	1221
409	1227
412	1236
524	1572
532	1596
705	2115



STD 4,5M (Rubber)

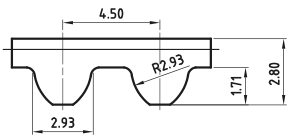

Number of teeth z	Length [mm]
36	162
47	211.5
48	216
50	225
52	234
53	239
56	252
63	284
66	297
68	306
70	315
74	333
76	342
78	351
80	360
82	369
88	396
111	500
112	504
122	550
126	567
140	630
145	653
158	711
164	738
178	801
192	864
201	905
207	931
211	950
229	1030.5

STD 5M (Rubber)

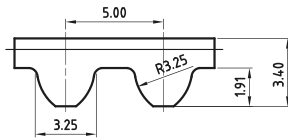

Number of teeth z	Length [mm]
45	225
46	230
51	255
52	260
53	265
54	270
57	285
59	295
60	300
64	320
65	325
68	340
70	350
74	370
75	375
76	380
77	385
78	390
80	400
82	410
83	415
84	420
85	425
86	430
87	435
89	445
90	450
91	455
95	475
98	490
100	500
102	510
104	520
105	525
107	535
108	540
110	550
112	560
113	565
115	575
118	590
120	600
122	610
123	615
125	625
127	635
128	640
129	645
130	650
131	655

STD 5M (Rubber)

Number of teeth z	Length [mm]
133	665
134	670
135	675
138	690
140	700
142	710
145	725
148	740
150	750
153	765
154	770
156	780
160	800
162	810
163	815
166	830
170	850
174	870
178	890
180	900
185	925
187	935
200	1000
210	1050
220	1100
223	1115
225	1125
227	1135
229	1145
230	1150
239	1195
240	1200
245	1225
254	1270
259	1295
270	1350
276	1380
284	1420
300	1500
315	1575
317	1585
319	1595
320	1600
321	1605
337	1685
338	1690
340	1700
360	1800
389	1945
400	2000
420	2100
429	2145
505	2525
656	3280



Chiorino Rubber Timing Belts

STD 8M (Rubber)

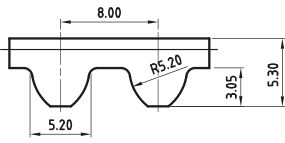

Number of teeth z	Length [mm]
47	376
50	400
53	424
55	440
58	464
60	480
61	488
62	496
64	512
65	520
66	528
70	560
72	576
73	584
74	592
75	600
76	608
79	632
80	640
82	656
85	680
87	696
89	712
90	720
94	752
95	760
97	776
99	792
100	800
103	824
104	832
105	840
106	848
107	856
108	864
110	880
111	888
112	896
113	904
114	912
115	920
116	928
117	936
118	944
119	952
120	960
122	976
123	984

STD 8M (Rubber)

Number of teeth z	Length [mm]
124	992
125	1000
127	1016
128	1024
129	1032
130	1040
132	1056
133	1064
134	1072
135	1080
137	1096
139	1112
140	1120
141	1128
142	1136
144	1152
145	1160
146	1168
148	1184
149	1192
150	1200
152	1216
153	1224
155	1240
156	1248
157	1256
158	1264
160	1280
162	1296
163	1304
164	1312
165	1320
168	1344
169	1352
170	1360
171	1368
173	1384
174	1392
175	1400
178	1424
180	1440
185	1480
189	1512
190	1520
191	1528
193	1544
194	1552
199	1592
200	1600
203	1624
204	1632
205	1640
206	1648
209	1672

STD 8M (Rubber)

Number of teeth z	Length [mm]
210	1680
212	1696
213	1704
215	1720
216	1728
220	1760
222	1776
224	1792
225	1800
235	1880
238	1904
239	1912
242	1936
244	1952
250	2000
254	2032
256	2048
257	2056
263	2104
265	2120
270	2160
280	2240
284	2272
288	2304
300	2400
304	2432
312	2496
313	2504
325	2600
335	2680
350	2800
356	2848
358	2864
360	2880
365	2920
381	3048
400	3200
410	3280
460	3680
610	4880
665	5320

STD 14M (Rubber)

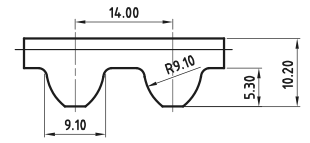

Number of teeth z	Length [mm]
51	714
69	966
72	1008
80	1120
85	1190
89	1246
92	1288
96	1344
100	1400
104	1456
108	1512
110	1540
115	1610
125	1750
126	1764
127	1778
129	1806
135	1890
143	2002
150	2100
160	2240
165	2310
166	2324
170	2380
175	2450
182	2548
185	2590
190	2660
200	2800
225	3150
240	3360





Classical and Narrow V-belts are an excellent solution for a wide range of drives. Classical V-belts are available in Z,A,B,C and D section, whereas Narrow V-belts in SPZ, SPA, SPB and SPC section. In both cases belts are wrapped with a textile cover. It assures maximum protection against heat, oil and ozone.

Cogged Raw Edge V-Belts replace traditional V-belts in demanding drive systems where space and weight reduction is crucial. Superior design delivers maximum power and high speed - even in pulleys with very small diameter. They are available in AX, BX, CX, XPZ, XPA, XPB, XPC, 3VX and 5VX section.

Thanks to a unique production cycle (according to UNISSET technology) we are able to secure limited and constant tolerance of these belts. The precise dimensions of this product fits perfectly in applications of the industrial and agricultural market.

Properties:

- Low-stretch cords - extended lifetime & great performance
- Wrapping - maximum cover against heat, oil, ozone
- UNISSET technology - dimensional stability guarantee
- Temperature range: -20°C ~ +70°C (-25°C ~ + 80°C for cogged belts)

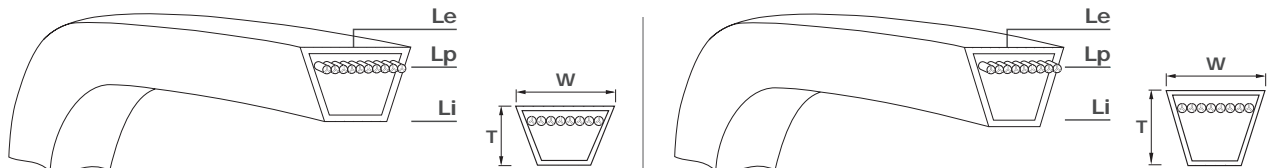

SECTION		CLASSICAL V-BELTS					WRAPPED NARROW V-BELT			
		Z	A	B	C	D	SPZ	SPA	SPB	SPC
Back width	W (mm)	10	13	17	22	32	9,7	12,7	16,3	22
Height	T (mm)	6	8	11	14	20	8	10	13	18
Primitive length	Lp=Li+ (mm)	22	30	43	55	75				
Internal length	Li=Lp-(mm)						37	45	60	83
External length	Le=Li+ (mm)	38	50	66	85	126	13	18	22	30
Minimum pulley diam.	d (mm)	50	63	100	160	300	63	90	140	224
Weight	(kg/m)	0,06	0,108	0,185	0,298	0,595	0,065	0,115	0,200	0,250
Maximum speed	v(m/s)	33					42			

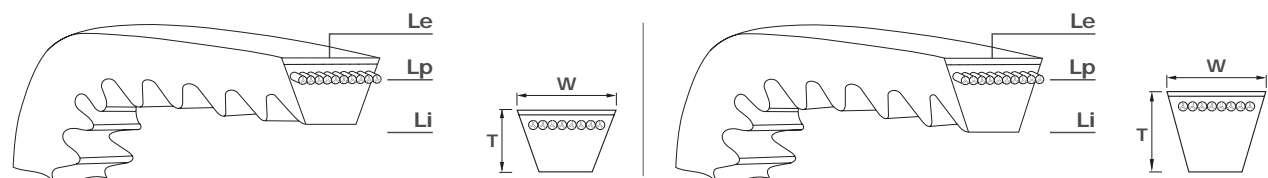

SECTION		COGGED RAW EDGE V-BELT								
		AX	BX	CX	XPZ	XPA	XPB	XPC	3VX	5VX
Back width	W (mm)	12,7	16,3	22	9,7	12,7	16,3	22	9	15
Height	T (mm)	8	11	14	8	10	13	18	8	13
Primitive length	Lp=Li+ (mm)	30	43	55					4	11
Internal length	Li=Lp-(mm)				37	45	60	83		
External length	Le=Li+ (mm)	50	66	85	51	63	82	113		
Minimum pulley diam.	d (mm)	50	80	140	56	71	112	180	56	112
Weight	(kg/m)	0,080	0,165	0,250	0,060	0,110	0,185	0,330	0,060	0,183
Maximum speed	v(m/s)	48								

The Poly V belts is a power transmission belt featuring lengthwise grooves. It operates from contact between the ribs of the belt and the grooves in the pulley.

Its single-piece structure guarantees an even distribution of tension across the width of the pulleys where the belt is in contact.

Poly V[®] belts

PJ SECTION		
Effective Length		Nb. of ribs (max)
mm	ins	
197	7,8	190
207	8,2	190
234	9,2	190
254	10,0	190
267	10,5	190
274	10,8	190
305	12,0	190
330	13,0	190
356	14,0	190
381	15,0	190
406	16,0	190
432	17,0	190
457	18,0	190
483	19,0	190
508	20,0	190
533	21,0	190
559	22,0	190
584	23,0	190
610	24,0	190
635	25,0	190
660	26,0	190
711	28,0	190
723	28,5	190
762	30,0	190
787	31,0	190
813	32,0	190
838	33,0	190
864	34,0	190
889	35,0	190
914	36,0	190
938	36,9	190
960	37,8	190
995	39,2	190
1016	40,0	190
1041	41,0	190
1059	41,7	190
1080	42,5	190
1092	43,0	190
1110	43,7	190

Effective Length		Nb. of ribs (max)
mm	ins	
1118	44,0	190
1126	44,3	190
1130	44,5	190
1143	45,0	190
1150	45,3	190
1168	46,0	190
1200	47,2	190
1210	47,6	190
1222	48,1	190
1233	48,5	190
1244	49,0	190
1262	49,7	190
1270	50,0	190
1280	50,4	190
1295	51,0	190
1301	51,2	190
1315	51,8	190
1321	52,0	190
1333	52,5	190
1355	53,3	190
1372	54,0	190
1397	55,0	190
1428	56,2	190
1473	58,0	190
1549	61,0	190
1600	63,0	190
1651	65,0	190
1663	65,5	190
1752	69,0	190
1854	73,0	190
1895	74,6	190
1910	75,2	190
1956	77,0	190
1992	78,4	190
2083	82,0	190
2155	84,8	190
2210	87,0	190
2286	90,0	190
2337	92,0	190
2413	95,0	190
2489	98,0	190
3154	124,2	190
3500	137,8	190
4000	157,5	190

PL SECTION		
Effective Length		Nb. of ribs (max)
mm	ins	
954	37,6	100
991	39,0	100
1 075	42,3	100
1 270	50,0	100
1 333	52,5	100
1 371	54,0	100
1 397	55,0	100
1 422	56,0	100
1 480	58,3	100
1 562	61,5	100
1 613	63,5	100
1 664	65,5	100
1 715	67,5	100
1 764	69,4	100
1 803	71,0	100
1 841	72,5	100
1 943	76,5	100
1 981	78,0	100
2 020	79,5	100
2 070	81,5	100
2 096	82,5	100
2 134	84,0	100
2 197	86,5	100
2 235	88,0	100
2 324	91,5	100
2 362	93,0	100
2 476	97,5	100
2 515	99,0	100
2 705	106,5	100
2 743	108,0	100
2 845	112,0	100
2 895	114,0	100
2 921	115,0	100
2 997	118,0	100
3 086	121,5	100
3 124	123,0	100
3 289	129,5	100
3 327	131,0	100
3 492	137,5	100

Effective Length		Nb. of ribs (max)
mm	ins	
3 696	145,5	100
4 051	159,5	100
4 191	165,0	100
4 318	170,0	100
4 470	176,0	100
4 622	182,0	100
5 029	198,0	100
5 385	212,0	100
6 096	240,0	100

On request: PH, PK, PM.

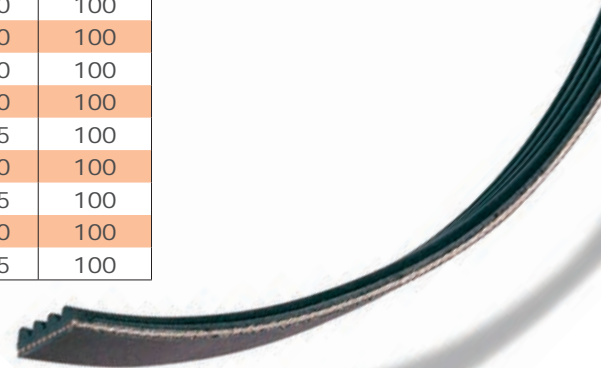













Coatings & specials

- 1 False teeth (for screwed cleats)
- 2 Mechanical joining system
- 3 PVC Super Grip (Red)
- 4 Cover PU CC Blue
- 5 Belt with brushes











Coatings

Chiorino timing belts can be supplied with vulcanized or glued covers. The variety of material which can be used as a covering varies from application type. The coating can be used to reduce noise, modify friction or used as a conveying element. Chiorino is able to provide our customer following types of coverings:

	Type	Raw material	Thickness [mm]	Color	Hardness [ShA]	C _D *	Contact temperature max	Oil and fat resistance	Coeff. of friction on steel	FDA food grade
	PAZ/PAR	Polyamide	-	Green	-	-	+80	-	0,25	No
	Sylomer	PU	6; 12; 25	Yellow Blue Green Brown	6 10 15 23	13 20	+70	medium	0,5	No
	PU Yellow	PU	2; 3; 4	Yellow	55 70	20	+70	high	0,3	No
	Fishbone	PU	5	Transparent	70	30	+70	medium	0,7	No
	PU Ribbed	PU	2; 3; 4	Transparent	85	30	+70	high	0,6	No
	APL	PU	3,5	Red	55	22	+60	high	0,7	No
	AVAFC	PU	2; 3; 4	Transparent	85	25-30	+70	high	0,6	No
	Celloflex	PU Foam	2; 4; 6; 8; 10	Beige	-	16	+80	medium	0,3	No
	Super Grip	Rubber PVC	3-4 5	Green Red	40-55	20	+60	medium	0,9	No
	PVC Green	PVC	2; 3	Green	40	20	+60	high	0,9	No
	Silicon	Silicon	2; 3; 4 2; 3; 5	Transparent Ivory	50 40	20	+160	high	1,1	No
	Silon	PET	2	Anthracite White	-	20	+100	low	0,2	No / Yes

*Pulley minimum diameter = backing thickness x C_D

At the customers request it is possible for us to provide Chiorino timing belts with special antistatic properties by using a specific electrically conductive coating or a special compound.

	Type	Raw material	Thickness [mm]	Color	Hardness [ShA]	C _D *	Contact temperature max	Oil and fat resistance	Coeff. of friction on steel	FDA food grade
	LC-G R	Rubber	2-10	Red	45	15	+80	low	1,0	No
	LC-G L	Rubber	2-10	Raspberry	35	15	+80	low	1,1	No
	Rubber	Rubber	3; 6; 10; 12	White Black	65	20				
	Linatrilite	Rubber	3; 6; 10	Orange	55	20	+110	medium	1,0	No
	Correx	Para rubber	6; 10	Brown	40	16	+60	low	0,6	No
	Porol	Cellular rubber	2; 3; 6; 10	Black	-	6	+70	medium	1,0	No
	TW200	Sponge rubber	6; 12; 15; 20; 40	Orange	-	13	+65	low	1,0	No
	SG70 F-T	Sponge rubber	10	Green	-	15	+65	low	1,0	No
	X-W 60GP SR	Elastomer NBR (synthetic)	6	Red	45	20	+120	low	0,8	No
	X-W 60GP NR	Elastomer NR (natural)	6	Red	45	20	+80	low	0,8	No
	X-W 70FL NR	Elastomer (natural)	7	Red	45	20	+80	low	1,0	No
	PU HP BLUE	PU	1; 2	Blue	85	12	+60	high	0,6	Yes
	PU HP WHITE	PU	1	White	85	12	+60	high	0,6	Yes
	PU HP CC BLUE	PU	2	Blue	85	12	+60	high	0,6	Yes
	PU HP PM BLUE	PU	1,5	Blue	85	12	+60	high	0,6	Yes
	PU HP LG BLUE	PU	1,7	Blue	85	12	+60	high	0,6	Yes

*Pulley minimum diameter = backing thickness x C_D

Seamless belts for vertical form fill sealers

Chiorino manufactures a wide range of high performing seamless belts, suitable for the form fill sealing by any packaging material (polyethylene and PVC films, paper, fabric, etc.). Where required, a timing belt can be applied on the bottom surface to provide absolute synchronous drive, avoiding any risk of slippage.

OEM	Belt size	Drawing no	Code	Special executions						
				Perforated	Perforated oval holes	Grooved on timing side	Countersunk	Vertical slots	Diagonal slots left	Diagonal slots right
BOSCH	50T10/920 + 4 mm	B.01.1	110227620003	•	•	•		•		
	50T10/920 + 4 mm	B.01.2	110227620004	•	•	•			•	
	50T10/920 + 4 mm	B.01.5	110227620005	•	•	•				•
	50T10/920 + 4 mm	B.01.6	110227620006	•	•	•			•	
	50T10/920 + 4 mm	B.02.7	110228194217	•	•	•				•
	50T10/920 + 4 mm	B.02.8	110228194218	•	•	•				•
	50T10/920 + 4 mm	B.01.7	110227620007	•	•	•		•		
	30T10/920 + 4 mm	B.01.10	110227620009	•	•	•		•		
	30T10/920 + 4 mm	B.01.11	110227620008	•	•	•			•	
	50T10/920 + 4 mm	B.02.3	110228194211	•	•	•				•
50T10/920 + 4 mm	B.02.4	110228194212	•	•	•			•		
ILAPAK	50T10/530 + 4 mm	I.01.3	110228194237	•	•	•				•
	50T10/530 + 4 mm	I.01.4	110228194238	•	•	•			•	
	50T10/530 + 4 mm	I.02.5	110228194235	•	•	•				•
	50T10/530 + 4 mm	I.02.6	110228194236	•	•	•				•
KAWASHIMA	300L157 + 3 mm	K.01.1	110228221366	•		•	•			
ROVEMA	50T10/630 + 6,4 mm	R.02.1	110228194262	•		•	•			
	30T10/630 + 6,4 mm	R.02.2	110228194263	•		•				
	50T10/630 + 6,4 mm	R.02.3	110228194352	•		•				
TNA	367L + 6 mm	T.02.1	110228221367	•	•	•				
	367L + 6 mm	T.02.2	110228220972	•	•	•				
ISHIDA	255H + 3,5 mm	IS.02.1	110228230774	•		•				



Example of special execution

MF Chiorino seamless belts can be supplied with special executions according to customer's needs.

Diagonal slots and grooved on timing side

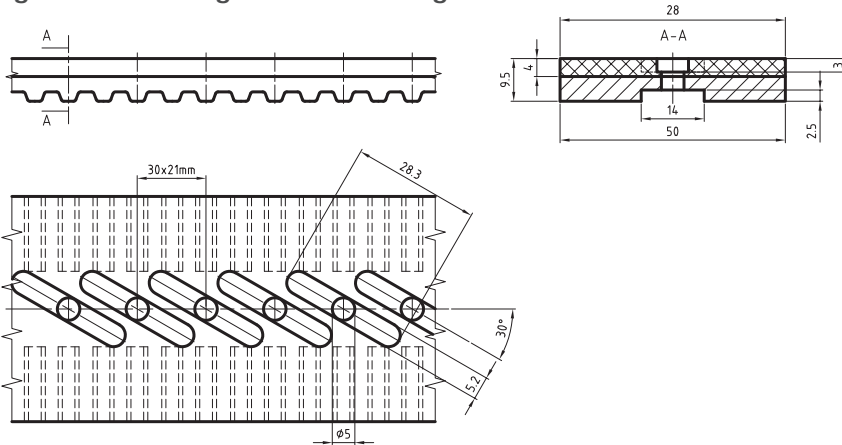

Countersunk and grooved on timing side

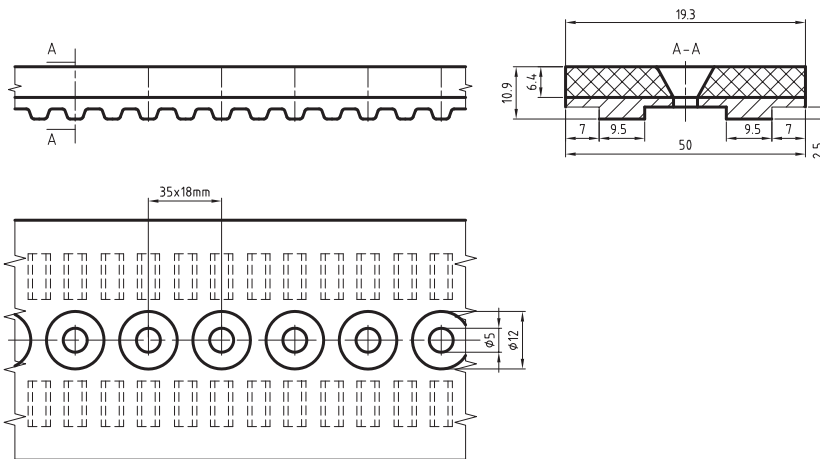

Vertical slots and grooved on timing side

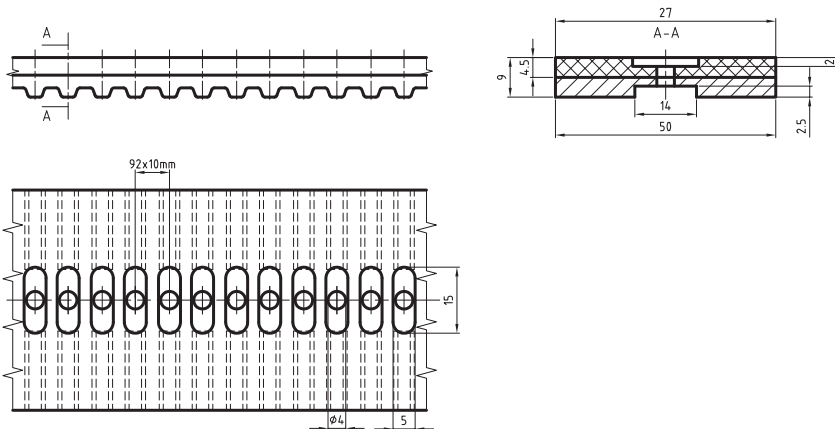

Vulcanized belts

Chiorino timing belts can be supplied with vulcanized cover.

Imperial pitch

Belt type	Number of teeth z	Lenght mm	Rubber belts	PU belts	Max width mm
100 XL	50	254,00	•		440
150 XL	75	381,00	•		440
150 L	40	381,00	•		440
187 L	50	476,25	•		440
203 L	54	514,35	•		440
210 L	56	533,40	•		440
225 L	60	571,50	•		440
240 L	64	609,60	•		440
255 L	68	647,70	•		440
270 L	72	685,80	•		440
367 L	98	933,45	•		440
240 H	48	609,60	•		440
255 H	51	647,70	•		440
270 H	54	673,10	•		440
300 H	60	762,00	•		440

Metric pitch

Belt type	Number of teeth z	Lenght mm	Rubber belts	PU belts	Max width Rubber/PU mm
T5 165	33	165,00		•	200
T5 630	126	630,00		•	200
T10 440	44	440,00	•	•	440/200
T10 480	48	480,00	•		440
T10 500	50	500,00	•		440
T10 510	51	510,00		•	200
T10 530	53	530,00	•	•	440/200
T10 560	56	560,00	•	•	440/200
T10 630	63	630,00	•	•	440/200
T10 660	66	660,00	•	•	440/200
T10 700	70	700,00	•	•	440/200
T10 840	84	840,00		•	200
T10 920	92	920,00	•	•	440/200
AT5 660	132	660,00		•	200
AT10 800	80	800,00		•	200
AT10 840	84	840,00		•	200
HTD3M 420	140	420,00	•		440
STD8M 560	70	560,00	•		440
STD8M 656	82	656,00	•		440
PJ 483	-	483,00	•		440
PJ 813	-	813,00	•		440

Available from stock

Type	Hardness [ShA]	Max thicknwss mm	Color	CD*	Other
RN-L	35	8	raspberry	12	
RN-R	45	8	red	12	
RN-B	50	8	beige	15	
RBS/RN-BK	55	8	black	18	oil-resistans
RN-W FDA	65	8	white	20	food approved

* pulley minimum diameter = thickness x C_D

Other dimensions on request.

Chiorino offers standard and special pulleys which are produced on customer demand. The pulleys are made according to ISO specification and provide a complete drive solution.

Pulleys

RTD	RTD5 – RTD8 – RTD14
Metric	T2,5 – T5 – T10 – T20 – AT5 – AT10 – AT20 – TK5 – TK10 – TK20 – ATK10 – ATP10
Poly Chain	GT8M – GT14M
HTD	3M – 5M – 8M – 14M
Imperial	MXL – XL – L – H
STD	STD5M

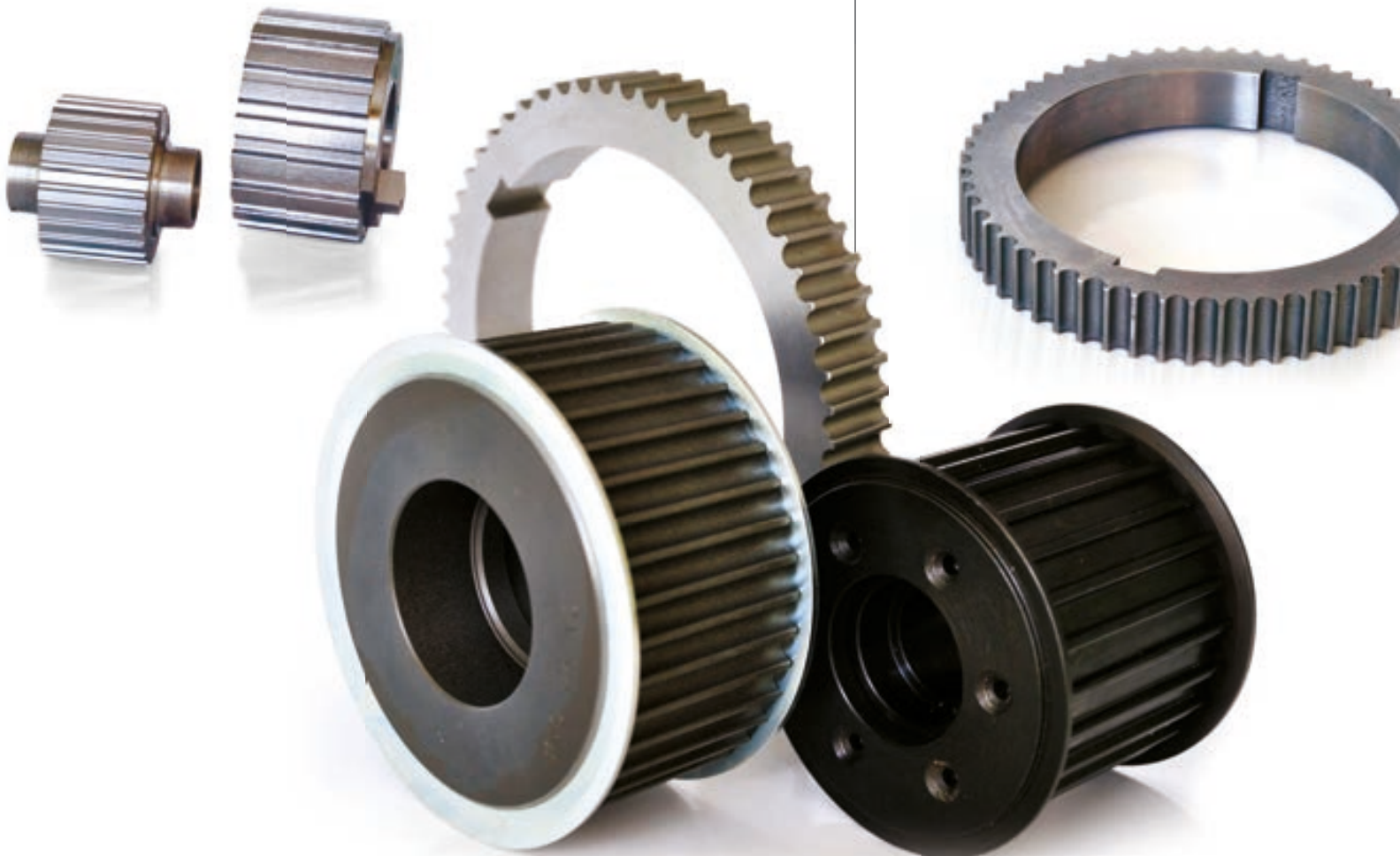

Associated companies

43



ITALY - Headquarters

CHIORINO SPA

Via S. Agata 9
13900 Biella
phone: +39-015.84891
fax: +39-015.8496161
chiorino@chiorino.com
www.chiorino.com

UNITED KINGDOM and IRELAND

CHIORINO UK LTD

Phoenix Avenue, Green Lane Industrial Park
FEATHERSTONE, West Yorkshire WF7 6EP
phone: +44-1977.691880
fax: +44-1977.791547
sales@chiorino.co.uk
www.chiorino.co.uk

FRANCE

CHIORINO SAS

Z.I. de l'Esplanade - 12-14, rue Paul-Henri Spaak
SAINT THIBAUT DES VIGNES - 77400 LAGNY
phone: +33-1.64304075
fax: +33-1.64305851
chiorino.paris@chiorino.fr
www.chiorino.fr

SPAIN

CHIORINO SA

Pasaje Puig i Cadafalch, 13
08191 RUBI' (BARCELONA)
phone: +34-93.5860480
fax: +34-93.6979121
chiorino@chiorino.es
www.chiorino.es

GERMANY

CHIORINO GMBH

Nikolaus-Kopernikus-Straße 9
55129 MAINZ
phone: +49-(0)6131.554490
fax: +49-(0)6131.5544920
info@chiorino.de
www.chiorino.de

THE NETHERLANDS

CHIORINO BENELUX BV

Westkanaaldijk 5-07
3542-DA UTRECHT
phone: +31-30.2413060
fax: +31-30.2413059
chiorino@chiorino.nl
www.chiorino.nl

BRASIL

CHIORINO LIMITADA

Rua Calandra, 62
02275-000 São Paulo
phone: +54-11-2584-1510
fax: +54-11-2584-1511
chiorino@chiorino.com.br
www.chiorino.com.br

Associated companies

POLAND

CHIORINO SP Z OO
ul. Piękna 13, 85-303 BYDGOSZCZ
phone: +48-052.3487708
fax: +48-52.3487707
chiorino@chiorino.com.pl
www.chiorino.com.pl

BELARUS

CHIORINO K
901-31, Kuzme Chornogo Str.
220012 MINSK
phone: +375-17.2804578
fax: +375-17.2856467
general@chiorino.ru
www.chiorino.ru

ROMANIA

CHIORINO SRL
B-dul Muncii nr. 18
CLUJ NAPOCA
Phone/fax: +40-264.432977
chiorino@chiorino.ro
www.chiorino.ro

HUNGARY

CHIORINO KFT
IPAR U.8.
2310 SZIGETSZETMIKLÓS HU
phone: +36-1.2785270
fax: +36-1.2785279
mail@chiorino.hu
www.chiorino.hu

U.S.A.

CHIORINO INC.
Harmony Business Park, 125 Ruthar Drive
DE 19711 NEWARK
phone: +1-302.2921906
fax: +1-302.2928777
info@chiorino.us
www.chiorino.us

SOUTH AFRICA

CHIORINO SOUTH AFRICA PTY LTD
DURBAN, P.O. Box 15015 - WESTMEAD 3608
KWAZULU NATAL
phone: +2731.7925500
fax: +2731.7925525
sales@chiorino.co.za

AUSTRALIA and NEW ZEALAND

CHIORINO AUSTRALIA PTY LTD
BRISBANE - 40 Corymbia Place
Parkinson Qld 4115
phone: +61-7.32741900
fax: +61-7.32741294
sales@chiorino.com.au
www.chiorino.com.au

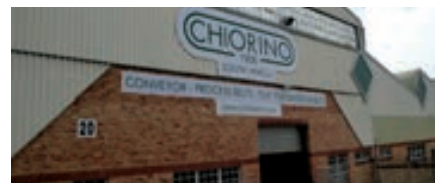

Form / Notes

Questionnaire for timing belts

Material	PU		Rubber	
Type (pitch)*				
Quantity of belts				
Length				mm
Width				mm
Circumference	Open		Joined	
Thickness				mm
Application	Transmission		Conveyor	
Type of industry				

* If you don't know type (pitch) of belt:	
Rapid per minute	rpm/min
Diameter of pulley	mm
Distance between axes of pulley	mm
Condition of work	

OTHER SERVICES	
Covering:	
Material:	
Thickness:	
Hardness:	
Structure:	
Guides and profiles:	
Thickness:	
Width:	
Height:	
Shape:	
Fabric covering:	PAZ
	PAR

Belt perforation:	
Diameter	mm
Number of holes	

Grinding:	
Width	mm

Others:	
---------	--

NOTES:	
--------	--

CHIORINO GROUP COMPANIES

Australia and New Zealand

CHIORINO AUSTRALIA PTY. LTD. - Brisbane
Tel. +61-7-3274 1900
sales@chiorino.com.au
www.chiorino.com.au

Benelux

CHIORINO BENELUX B.V. - Utrecht,
The Netherlands
Tel. +31-30-2413060
chiorino@chiorino.nl
www.chiorino.nl

Brazil

CHIORINO LIMITADA - São Paulo
Tel. +55-11-2584-1510
chiorino@chiorino.com.br
www.chiorino.com.br

Byelorussia

CHIORINO-K - Minsk
Tel. +375-17-2802486
general@chiorino.ru
www.chiorino.ru

China

CHIORINO LIAISON OFFICE - Shanghai
Tel. +86 21 37831019
info@chiorino.cn
www.chiorino.cn

France

CHIORINO SAS - Lagny, Paris
Tel. +33-1-64304075
chiorino.paris@chiorino.fr
www.chiorino.fr

Germany

CHIORINO GmbH - Mainz
Tel. +49-(0)6131-55449-0
info@chiorino.de
www.chiorino.de

Hungary

CHIORINO Kft. - Szigetszentmiklós
(Budapest)
Tel. +36-24-525930
mail@chiorino.hu
www.chiorino.hu

India

CHIORINO INDIA - Salcete-Goa
Tel. +918322782454
Fax +918322782456
info@chiorino.in
www.chiorino.in

Italy

CHIORINO PARMA s.r.l. - Parma
Tel. +39-0521-292236
chiorinoparma@chiorino.com

CHIORINO VENETO s.r.l. - Colle Umberto

Tel. +39-0438-430460
chiorinoveneto@chiorino.com

Poland

CHIORINO Sp. z o.o. - Bydgoszcz
Tel. +48-52-3487708
chiorino@chiorino.com.pl
www.chiorino.com

Portugal

CHIORINO PORTUGAL, LDA
Alfena Valongo, Porto
Tel. +35-122-9684442
geral@chiorino.pt

Romania

CHIORINO srl - Cluj Napoca
Tel. +40-264-432977
chiorino@chiorino.ro
www.chiorino.ro

Singapore

CHIORINO FAR EAST PTE. LTD. - Singapore
Tel. +65-67426266
sales@chiorino.com.sg
www.chiorino.com.sg

South Africa

CHIORINO SOUTH AFRICA (PTY) LTD. -
Durban
Tel. +27-31-7925500
sales@chiorino.co.za
www.chiorino.com

Spain

CHIORINO IBÉRICA S.A.U. - Rubí, Barcelona
Tel. +34-93-5860480
chiorino@chiorino.es
www.chiorino.es

United Kingdom and Ireland

CHIORINO U.K. Ltd. - Featherstone
Tel. +44-1977-691880
sales@chiorino.co.uk
www.chiorino.co.uk

U.S.A.

CHIORINO INC. - Newark, DE
Tel. +1-302-292-1906
info@chiorino.us
www.chiorino.us

CHIORINO DISTRIBUTORS

Argentina
Armenia
Azerbaijan
Belgium
Bosnia
Brazil
Colombia
Croatia
Cyprus
Czech Republic
Denmark
Egypt
Estonia
Finland
Greece
Herzegovina
Indonesia
Israel
Kazakhstan
Kirgyzstan
Latvia
Lithuania
Macedonia
Mexico
Moldova
Russia
Saudi Arabia
Serbia
Slovak Republic
Slovenia
Sweden
Tajikistan
Thailand
Turkey
Turkmenistan
Ukraine
Uzbekistan

HEADQUARTERS AND PRODUCTION PLANTS

CHIORINO S.p.A.

Via S. Agata, 9
I-13900 Biella, Italy
Tel. +39 015 8489 1
Fax +39 015 849 61 61
chiorino@chiorino.com
www.chiorino.com

TIMING BELTS AND PULLEYS

CHIORINO Sp. z o.o.

ul. Piękna 13
85-303 Bydgoszcz, Poland
Tel. +48 52 348 77 08
Fax +48 52 348 77 15
chiorino@chiorino.com.pl
www.chiorino.com

EMAS
UNI EN ISO 9001:2008
UNI EN ISO 14001:2004

ENGINEERING ADVICE
ON-SITE INSTALLATION SERVICE
AFTER SALES SUPPORT

